

Discover the beauty and functionality of Royal Botania Lighting. Our harmonious designs come in a variety of styles and are made from high-quality materials with cutting-edge technology. Enhance the appearance of your property and create a dynamic display with outdoor lighting that not only transforms its appearance at night, but also adds security to your driveways and entrance paths.

# AVAILABILITY OF PRODUCTS

PLEASE NOTE THAT SOME PRODUCT REFERENCES ARE MARKED WITH AN ASTERISK (\*), INDICATING THAT THEY ARE ONLY AVAILABLE WHILE SUPPLIES LAST. IF YOU WOULD LIKE MORE INFORMATION OR TO CHECK ON CURRENT STOCK, PLEASE CONTACT US.

## LEGEND

IP43 PROTECTED AGAINST OBJECTS > 1MM & PROTECTED AGAINST WATER SPRAYED AT MAX. ANGLE 60°

IP44 PROTECTED AGAINST OBJECTS > 1MM & WATER PROJECTIONS FROM ALL DIRECTIONS (360°)

IP55 PROTECTED AGAINST DUST & AGAINST WATER SPRAYED FROM ALL DIRECTIONS (360°)

IP65 TOTALLY SEALED AGAINST DUST & AGAINST WATER SPRAYED FROM ALL DIRECTIONS (360°)

IP68 TOTALLY SEALED AGAINST DUST & PROTECTED AGAINST PERMANENT IMMERSION

|   |                       |
|---|-----------------------|
|  | Protective category 1 |
|  | Protective category 2 |
|  | Protective category 3 |



|    |                      |    |               |
|----|----------------------|----|---------------|
| 4  | BEACON               | 50 | MOSO WALL     |
| 6  | BEACON WALL          | 52 | OMEGA WALL    |
| 8  | BEAMY                | 54 | PARKER        |
| 10 | BEAMY WALL           | 56 | PARKER WALL   |
| 14 | BULLET               | 58 | Q-BIC         |
| 16 | CLOCHE WALL          | 60 | Q-BIC WALL    |
| 20 | CLUB LOUNGE          | 64 | ROPY          |
| 22 | DOME CEILING         | 66 | ROPY TABLE    |
| 26 | DOME FLOOR           | 70 | RUSTY         |
| 28 | DOME GATE            | 72 | SEPTEM        |
| 30 | DOME MOVE            | 74 | SPIKY         |
| 34 | DOME SMALL           | 76 | SPOTTY        |
| 36 | DOME WALL            | 80 | TESLA CEILING |
| 38 | DOME GLASS VARIETIES | 82 | TESLA WALL    |
| 40 | FUNGY                | 86 | TRISTAR       |
| 44 | LUNIZ                | 90 | ACCESSORIES   |
| 48 | MEDUZ                | 91 | MATERIALS     |

# BEACON

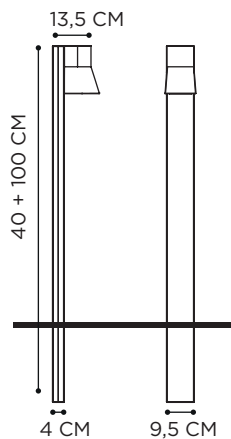





TEAK



PORCELAIN: BLACK/WHITE



| REFERENCE | DESCRIPTION   | INTEGRATED LIGHT | WATT  | K    | LM  | INPUT    | IP | EEC   |
|-----------|---|------------------|-------|------|-----|----------|----|---|
| BCN140B   |  BLACK | LED              | 2,2 W | 2700 | 390 | 100-240V | 65 | C  |
| BCN140W   |  WHITE | LED              | 2,2 W | 2700 | 390 | 100-240V | 65 | C  |

INCLUDES 250mA DRIVER

INSTALLATION OPTION: JUB5625



BEACON WHITE PORCELAIN

# BEACON WALL

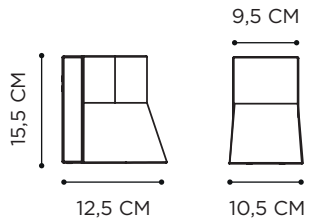
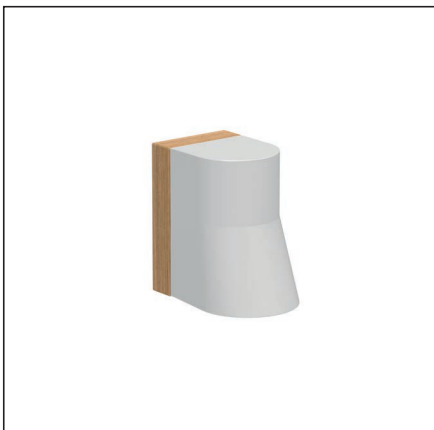





TEAK



PORCELAIN: BLACK/WHITE



| REFERENCE | DESCRIPTION   | INTEGRATED LIGHT | WATT  | K    | LM  | INPUT    | IP | EEC   |
|-----------|---|------------------|-------|------|-----|----------|----|---|
| BCNWB     |  BLACK | LED              | 2,2 W | 2700 | 390 | 100-240V | 65 | C  |
| BCNWW     |  WHITE | LED              | 2,2 W | 2700 | 390 | 100-240V | 65 | C  |

INCLUDES 250mA DRIVER





BEACON WALL WHITE PORCELAIN

# BEAMY

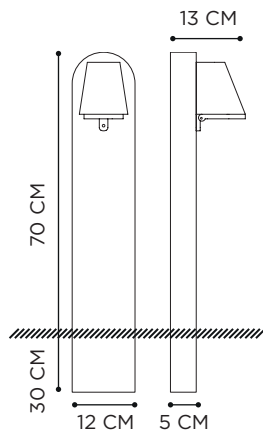

TEAK



ANTIQUE ZINC













ANTIQUE BRASS

WEATHERED BRASS



POWDER COATED ALUMINIUM: ANTHRACITE/WHITE



| REFERENCE   | DESCRIPTION   | LIGHTBULB SOCKET                     | WATT | INPUT | IP | EEC   |
|-------------|---|--------------------------------------|------|-------|----|---|
| BMY100230AZ |  ANTIQUE ZINC    | GU10 - LED FLAT OPTIC (NOT INCLUDED) | 5 W  | 230V  | 44 | A-G  |
| BMY100230AB |  ANTIQUE BRASS   | GU10 - LED FLAT OPTIC (NOT INCLUDED) | 5 W  | 230V  | 44 | A-G  |
| BMY100230WB |  WEATHERED BRASS | GU10 - LED FLAT OPTIC (NOT INCLUDED) | 5 W  | 230V  | 44 | A-G  |
| BMY100230A  |  ANTHRACITE      | GU10 - LED FLAT OPTIC (NOT INCLUDED) | 5 W  | 230V  | 44 | A-G  |
| BMY100230WR |  WHITE           | GU10 - LED FLAT OPTIC (NOT INCLUDED) | 5 W  | 230V  | 44 | A-G  |

INSTALLATION OPTION: JUB5625





BEAMY ANTHRACITE COATED - ALURA 195 LOUNGER - BUTLER 40 SIDE TABLE



# BEAMY WALL

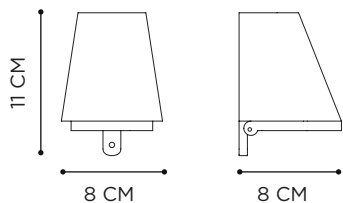

ANTIQUE ZINC



ANTIQUE BRASS

WEATHERED BRASS

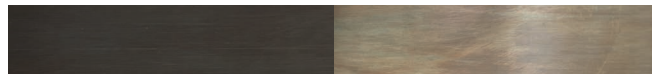

POWDER COATED ALUMINIUM: ANTHRACITE/WHITE

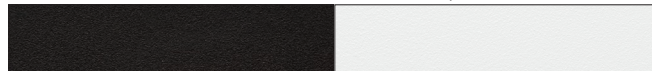

| REFERENCE | DESCRIPTION     | LIGHTBULB SOCKET                     | WATT | INPUT | IP | EEC |
|-----------|-----------------|--------------------------------------|------|-------|----|-----|
| BMYW230AZ | ANTIQUE ZINC    | GU10 - LED FLAT OPTIC (NOT INCLUDED) | 5 W  | 230V  | 44 | A-G |
| BMYW230AB | ANTIQUE BRASS   | GU10 - LED FLAT OPTIC (NOT INCLUDED) | 5 W  | 230V  | 44 | A-G |
| BMYW230WB | WEATHERED BRASS | GU10 - LED FLAT OPTIC (NOT INCLUDED) | 5 W  | 230V  | 44 | A-G |
| BMYW230A  | ANTHRACITE      | GU10 - LED FLAT OPTIC (NOT INCLUDED) | 5 W  | 230V  | 44 | A-G |
| BMYW230WR | WHITE           | GU10 - LED FLAT OPTIC (NOT INCLUDED) | 5 W  | 230V  | 44 | A-G |



ANTIQUE ZINC



ANTIQUE BRASS



WEATHERED BRASS



ANTHRACITE COATED



WHITE COATED





BEAMY WALL ANTIQUE ZINC









# BULLET

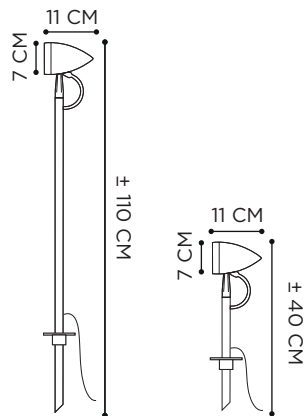

ANTIQUE BRASS



ANTIQUE ZINC



| REFERENCE | DESCRIPTION            | INTEGRATED LIGHT                     | WATT | INPUT | IP | EEC |
|-----------|------------------------|--------------------------------------|------|-------|----|-----|
| BLTG230AB | 40 CM - ANTIQUE BRASS  | GU10 - LED FLAT OPTIC (NOT INCLUDED) | 5 W  | 230V  | 44 | A-G |
| BLTG230AZ | 40 CM - ANTIQUE ZINC   | GU10 - LED FLAT OPTIC (NOT INCLUDED) | 5 W  | 230V  | 44 | A-G |
| BLT230AB  | 110 CM - ANTIQUE BRASS | GU10 - LED FLAT OPTIC (NOT INCLUDED) | 5 W  | 230V  | 44 | A-G |
| BLT230AZ  | 110 CM - ANTIQUE ZINC  | GU10 - LED FLAT OPTIC (NOT INCLUDED) | 5 W  | 230V  | 44 | A-G |

INFO: ADJUSTABLE HEAD





# CLOCHE WALL

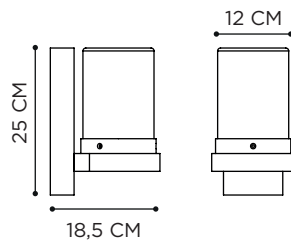

TEAK



MOUTHBLOWN GLASS: CLEAR



| REFERENCE | DESCRIPTION | LIGHTBULB SOCKET              | WATT | K    | LM  | INPUT | IP | EEC |
|-----------|-------------|-------------------------------|------|------|-----|-------|----|-----|
| CLOW      | CLEAR       | E27 - DECORATIVE LED INCLUDED | 4 W  | 2200 | 280 | 230V  | 44 | A-G |





CLOCHE WALL - MAMBO LOUNGE - RUG 2535 SAND









# CLUB LOUNGE

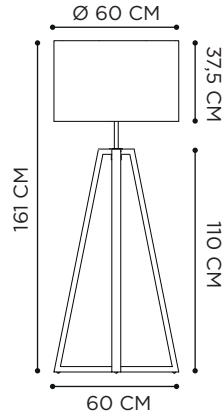





TEAK

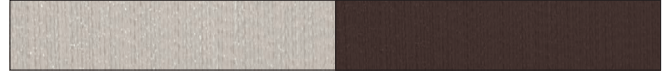

LAMP SHADE: TRANSPARENT/AMBER



| REFERENCE | DESCRIPTION   | INTEGRATED LIGHT | WATT  | K    | LM  | INPUT    | IP | EEC   |
|-----------|---|------------------|-------|------|-----|----------|----|---|
| CLBLTR    |  TRANSPARENT SHADE | LED              | 4,3 W | 2700 | 700 | 100-240V | 65 | D  |
| CLBLAM    |  AMBER SHADE       | LED              | 4,3 W | 2700 | 700 | 100-240V | 65 | D  |

CORD LENGTH: 4 METER

POWER SUPPLY: 500MA DRIVER INCLUDED





CLUB LOUNGE WITH TRANSPARENT LAMP SHADE - MAMBO LOUNGE - RUG 2535 SAND

# DOME CEILING

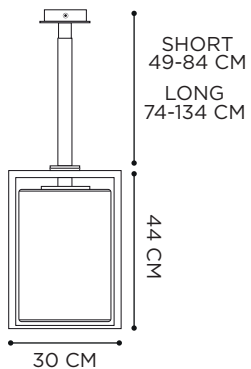

POWDER COATED ALUMINIUM: ANTHRACITE



MOUTHBLOWN GLASS: CLEAR/SMOKE



| REFERENCE | DESCRIPTION       | LIGHTBULB SOCKET              | WATT | K    | LM  | INPUT | IP | EEC |
|-----------|-------------------|-------------------------------|------|------|-----|-------|----|-----|
| DOMECBCL  | 49-84 CM - CLEAR  | E27 - DECORATIVE LED INCLUDED | 4 W  | 2200 | 280 | 230V  | 43 | A-G |
| DOMECBSM  | 49-84 CM - SMOKE  | E27 - DECORATIVE LED INCLUDED | 4 W  | 2200 | 280 | 230V  | 43 | A-G |
| DOMECLBCL | 74-134 CM - CLEAR | E27 - DECORATIVE LED INCLUDED | 4 W  | 2200 | 280 | 230V  | 43 | A-G |
| DOMECLBSM | 74-134 CM - SMOKE | E27 - DECORATIVE LED INCLUDED | 4 W  | 2200 | 280 | 230V  | 43 | A-G |





DOME CEILING 74-134CM WITH CLEAR GLASS - DOME CEILING 49-84CM WITH SMOKE GLASS









DOME CEILING 49-84CM WITH CLEAR GLASS - TABOELA 220 DINING TABLE - O-ZON 55 DINING CHAIR

# DOME FLOOR

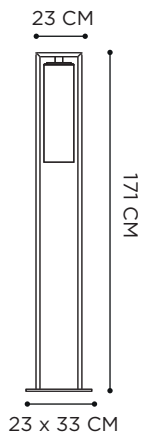

POWDER COATED ALUMINIUM: ANTHRACITE



MOUTHBLOWN GLASS: CLEAR/SMOKE



| REFERENCE | DESCRIPTION | LIGHTBULB SOCKET              | WATT | K    | LM  | INPUT | IP | EEC |
|-----------|-------------|-------------------------------|------|------|-----|-------|----|-----|
| DOMEFBCL  | CLEAR       | E27 - DECORATIVE LED INCLUDED | 4 W  | 2200 | 280 | 230V  | 43 | A-G |
| DOMEFBSM  | SMOKE       | E27 - DECORATIVE LED INCLUDED | 4 W  | 2200 | 280 | 230V  | 43 | A-G |

CORD LENGTH: 5 METER

INSTALLATION OPTION: JUB5625





DOME FLOOR WITH CLEAR GLASS

# DOME GATE

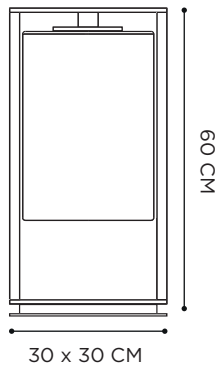





POWDER COATED ALUMINIUM: ANTHRACITE



MOUTHBLOWN GLASS: CLEAR/SMOKE



| REFERENCE | DESCRIPTION   | LIGHTBULB SOCKET              | WATT | K    | LM  | INPUT | IP | EEC   |
|-----------|---|-------------------------------|------|------|-----|-------|----|---|
| DOMEGTBCL |  CLEAR | E27 - DECORATIVE LED INCLUDED | 4 W  | 2200 | 280 | 230V  | 43 | A-G  |
| DOMEGTBSM |  SMOKE | E27 - DECORATIVE LED INCLUDED | 4 W  | 2200 | 280 | 230V  | 43 | A-G  |





DOME GATE WITH CLEAR GLASS

# DOME MOVE

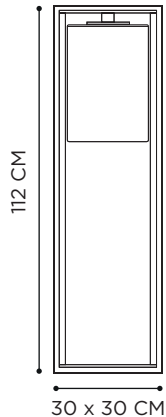





POWDER COATED ALUMINIUM: ANTHRACITE



MOUTHBLOWN GLASS: CLEAR/SMOKE



| REFERENCE | DESCRIPTION   | LIGHTBULB SOCKET              | WATT | K    | LM  | INPUT | IP | EEC   |
|-----------|---|-------------------------------|------|------|-----|-------|----|---|
| DOMEMBCL  |  CLEAR | E27 - DECORATIVE LED INCLUDED | 4 W  | 2200 | 280 | 230V  | 43 | A-G  |
| DOMEMBSM  |  SMOKE | E27 - DECORATIVE LED INCLUDED | 4 W  | 2200 | 280 | 230V  | 43 | A-G  |

CORD LENGTH: 5 METER

OPTIONAL GALVANIZED STEEL BALLAST: O3DOMEMBALLAST01





DOME MOVE WITH SMOKE GLASS - DOME WALL WITH CLEAR GLASS







# DOME SMALL

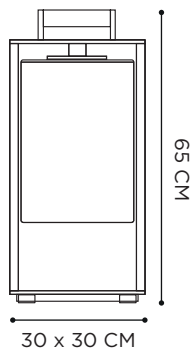

POWDER COATED ALUMINIUM: ANTHRACITE



MOUTHBLOWN GLASS: CLEAR/SMOKE



TEAK



| REFERENCE | DESCRIPTION | LIGHTBULB SOCKET              | WATT | K    | LM  | INPUT | IP | EEC |
|-----------|-------------|-------------------------------|------|------|-----|-------|----|-----|
| DOMESBCL  | CLEAR       | E27 - DECORATIVE LED INCLUDED | 4 W  | 2200 | 280 | 230V  | 43 | A-G |
| DOMESBSM  | SMOKE       | E27 - DECORATIVE LED INCLUDED | 4 W  | 2200 | 280 | 230V  | 43 | A-G |

CORD LENGTH: 4 METER





DOME SMALL WITH SMOKE & CLEAR GLASS

# DOME WALL

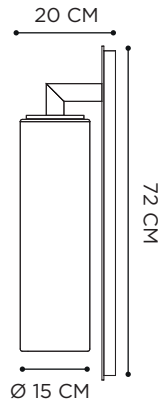





POWDER COATED ALUMINIUM: ANTHRACITE



MOUTHBLOWN GLASS: CLEAR/SMOKE



| REFERENCE | DESCRIPTION   | LIGHTBULB SOCKET              | WATT | K    | LM  | INPUT | IP | EEC   |
|-----------|---|-------------------------------|------|------|-----|-------|----|---|
| DOMEWBCL  |  CLEAR | E27 - DECORATIVE LED INCLUDED | 4 W  | 2200 | 280 | 230V  | 43 | A-G  |
| DOMEWBSM  |  SMOKE | E27 - DECORATIVE LED INCLUDED | 4 W  | 2200 | 280 | 230V  | 43 | A-G  |





DOME WALL WITH CLEAR GLASS

# DOME GLASS VARIETIES

## FLOOR / WALL



### REFERENCE

|             |                        |
|-------------|------------------------|
| 03DOMG01B   | CLEAR MOUTHBLOWN GLASS |
| 03DOMG01SMB | SMOKE MOUTHBLOWN GLASS |

## MOVE / SMALL / GATE / CEILING

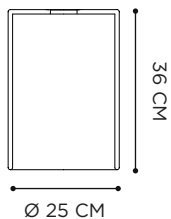

### REFERENCE

|             |                        |
|-------------|------------------------|
| 03DOMG02B   | CLEAR MOUTHBLOWN GLASS |
| 03DOMG02SMB | SMOKE MOUTHBLOWN GLASS |





— CLEAR



— SMOKE

# FUNGY

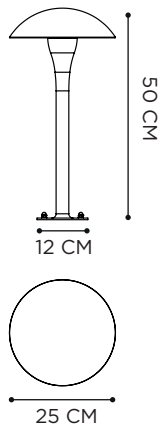

RUSTY IRON



WEATHERED BRASS



| REFERENCE | DESCRIPTION     | LIGHTBULB SOCKET        | WATT    | INPUT | IP | EEC |
|-----------|-----------------|-------------------------|---------|-------|----|-----|
| FGY50RI   | RUSTY IRON      | G9 - (LED NOT INCLUDED) | MAX 5 W | 230V  | 55 | A-G |
| FGY50WB   | WEATHERED BRASS | G9 - (LED NOT INCLUDED) | MAX 5 W | 230V  | 55 | A-G |

INSTALLATION OPTION: JUB5625















# LUNIZ

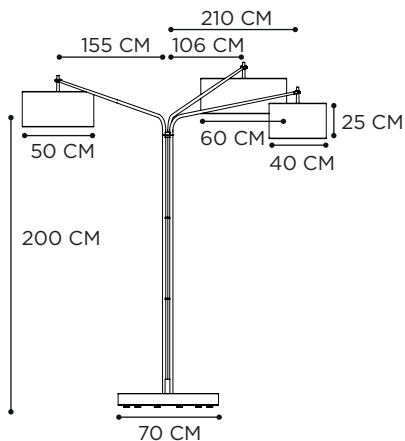

POWDER COATED STAINLESS STEEL FRAME

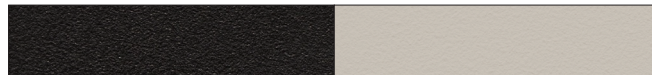

CERAMIC

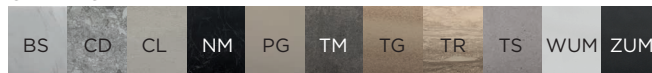





LAMP SHADE OPTION: POLYOLEFIN ROPE: BRONZE/GREEN/DESERT



LAMP SHADE OPTION: 70+ FABRICS



| REFERENCE   | DESCRIPTION  | LIGHTBULB SOCKET                  | WATT    | INPUT | IP | EEC   |
|---|--|-----------------------------------|---------|-------|----|---|
| LNZSMLA   |  ANTHRACITE | 3x E27 - DECORATIVE LEDS INCLUDED | MAX 15W | 230V  | 44 | A-G  |
| LNZSMLPB  |  PEBBLE     | 3x E27 - DECORATIVE LEDS INCLUDED | MAX 15W | 230V  | 44 | A-G  |
| LNZBASE70CERAM...(BS/CD/CL/NM/PG/TM/TG/TR/TS/WUM/ZUM) |  |                                   |         |       |    |   |
| LNZSHADEF40WR... (SEE FABRICS)                        |  |                                   |         |       |    |   |
| LNZSHADEF50WR... (SEE FABRICS)                        |  |                                   |         |       |    |   |
| LNZSHADEF60WR... (SEE FABRICS)                        |  |                                   |         |       |    |   |
| LNZSHADER40A... (BR/G/D)                              |  |                                   |         |       |    |   |
| LNZSHADER50A... (BR/G/D)                              |  |                                   |         |       |    |   |
| LNZSHADER60A... (BR/G/D)                              |  |                                   |         |       |    |   |

CORD LENGTH: 5M



LUNIZ ANTHRACITE COATED WITH BLACK & DESERT POLYOLEFIN ROPE LAMP SHADES - STYLETTO LOUNGE - RUG 2535 ROCK









# MEDUZ

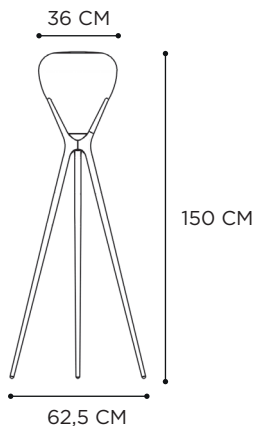



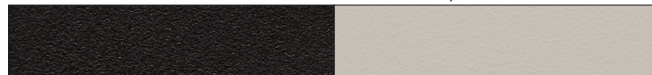

POWDER COATED ALUMINIUM: ANTHRACITE/PEBBLE



MOUTHBLOWN GLASS: SMOKE



| REFERENCE  | DESCRIPTION  | LIGHTBULB SOCKET                  | WATT | K   | LM   | INPUT | IP  | EEC   |
|------------|--|-----------------------------------|------|-----|------|-------|-----|---|
| MDZ15OASM  |  ANTHRACITE - SMOKE | E27 - DECORATIVE LED INCLUDED 4 W | 2200 | 280 | 230V | 43    | A-G |  |
| MDZ15OPBSM |  PEBBLE - SMOKE     | E27 - DECORATIVE LED INCLUDED 4 W | 2200 | 280 | 230V | 43    | A-G |  |

CORD LENGTH: 5M









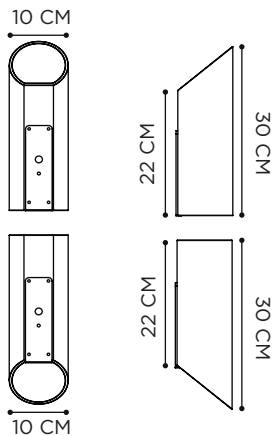
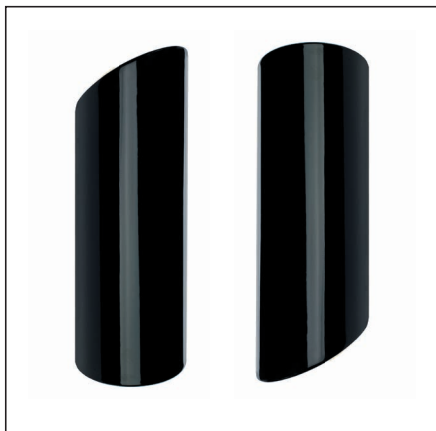







MEDUZ ANTHRACITE COATED WITH SMOKE GLASS - EXES 77 LOW DINING CHAIRS- BUTLER 40 & 60 SIDE TABLE - RUG 150 BARK

# MOSO WALL



PORCELAIN: WHITE/BLACK/NIGHT BLUE



| REFERENCE | DESCRIPTION   | INTEGRATED LIGHT | WATT | K    | LM  | INPUT | IP | EEC   |
|-----------|---|------------------|------|------|-----|-------|----|---|
| MSOWUW*   |  UP - WHITE        | LED              | 3 W  | 2700 | 450 | 230V  | 65 | D  |
| MSOWUB*   |  UP - BLACK        | LED              | 3 W  | 2700 | 450 | 230V  | 65 | D  |
| MSOWUNB*  |  UP - NIGHT BLUE   | LED              | 3 W  | 2700 | 450 | 230V  | 65 | D  |
| MSOWDW*   |  DOWN - WHITE      | LED              | 3 W  | 2700 | 450 | 230V  | 65 | D  |
| MSOWDB*   |  DOWN - BLACK      | LED              | 3 W  | 2700 | 450 | 230V  | 65 | D  |
| MSOWDNB*  |  DOWN - NIGHT BLUE | LED              | 3 W  | 2700 | 450 | 230V  | 65 | D  |

POWER SUPPLY: 350MA DRIVER INCLUDED





MOSO WALL DOWN NIGHT BLUE PORCELAIN

# OMEGA WALL

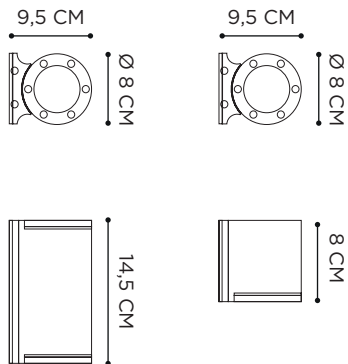

ELECTROPOLISHED STAINLESS STEEL



| REFERENCE  | DESCRIPTION | LIGHTBULB SOCKET                     | WATT | INPUT | IP | EEC |
|------------|-------------|--------------------------------------|------|-------|----|-----|
| OMG1D220EP | 1 SPOT      | GU10 - LED FLAT OPTIC (NOT INCLUDED) | 5 W  | 230V  | 55 | A-G |
| OMG2D220EP | 2 SPOTS     | GU10 - LED FLAT OPTIC (NOT INCLUDED) | 5 W  | 230V  | 55 | A-G |





# PARKER FLOOD & PATH

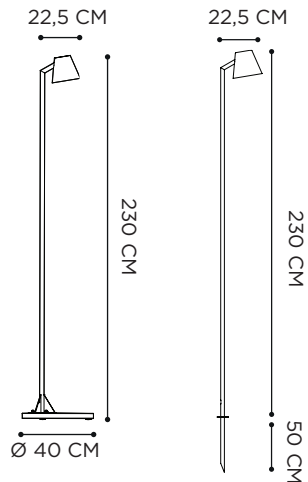

ANTIQUÉ BRASS

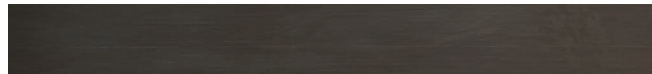

BLACK PEARL GRANITE

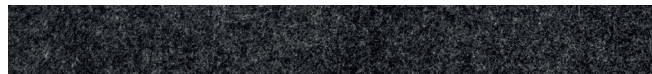

| REFERENCE        | DESCRIPTION | INTEGRATED LIGHT        | WATT    | K    | LM  | INPUT    | IP | EEC |
|------------------|-------------|-------------------------|---------|------|-----|----------|----|-----|
| PRKF             | WITH BASE   | LED                     | 4 W     | 2700 | 700 | 100-240V | 65 | C   |
| PRKP             | WITH SPIKE  | LED                     | 4 W     | 2700 | 700 | 100-240V | 65 | C   |
| LIGHTBULB SOCKET |             |                         |         |      |     |          |    |     |
| PRKF230          | WITH BASE   | GU10 (LED NOT INCLUDED) | MAX 5 W |      |     | 230V     | 55 | A-G |
| PRKP230          | WITH SPIKE  | GU10 (LED NOT INCLUDED) | MAX 5 W |      |     | 230V     | 55 | A-G |

CORD LENGTH: 5 METER  
LED INCLUDES 500mA DRIVER

PRKF: INCLUDES 40 CM GRANITE BASE  
PRKP: INCLUDES SPIKE





PARKER PATH WITH SPIKE

# PARKER WALL

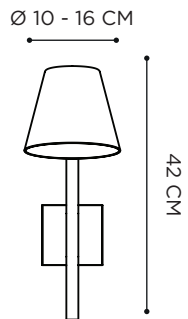

ANTIQUE BRASS



| REFERENCE               | DESCRIPTION   | INTEGRATED LIGHT        | WATT    | K    | LM  | INPUT    | IP | EEC |
|-------------------------|---------------|-------------------------|---------|------|-----|----------|----|-----|
| PRKW                    | ANTIQUE BRASS | LED                     | 3 W     | 2700 | 450 | 100-240V | 65 | D   |
| <b>LIGHTBULB SOCKET</b> |               |                         |         |      |     |          |    |     |
| PRKW230                 | ANTIQUE BRASS | GU10 (LED NOT INCLUDED) | MAX 5 W |      |     | 230V     | 55 | A-G |

LED INCLUDES 350mA DRIVER





PARKER WALL - STRAPPY 195 LOUNGER & FOOTREST

# Q-BIC

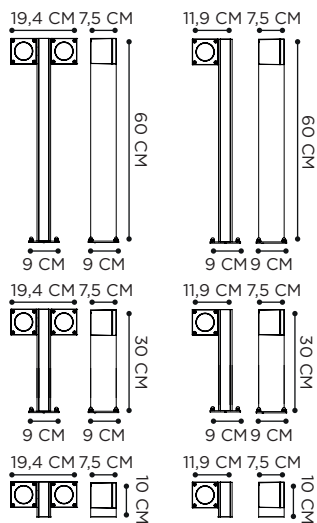
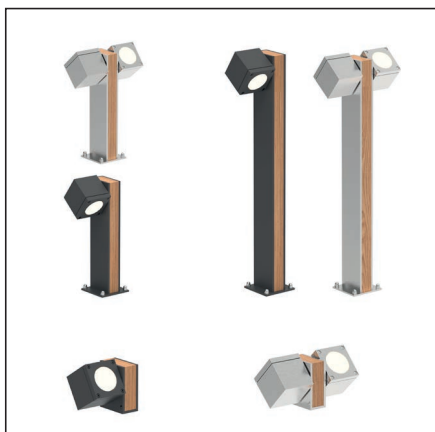

| REFERENCE   | DESCRIPTION               | LIGHTBULB SOCKET                     | WATT | INPUT | IP | EEC |
|-------------|---------------------------|--------------------------------------|------|-------|----|-----|
| QB301D220EP | 30 CM 1 SPOT - EP         | GU10 - LED FLAT OPTIC (NOT INCLUDED) | 5 W  | 230V  | 55 | A-G |
| QB302D220EP | 30 CM 2 SPOT - EP         | GU10 - LED FLAT OPTIC (NOT INCLUDED) | 5 W  | 230V  | 55 | A-G |
| QB601D220EP | 60 CM 1 SPOT - EP         | GU10 - LED FLAT OPTIC (NOT INCLUDED) | 5 W  | 230V  | 55 | A-G |
| QB602D220EP | 60 CM 2 SPOT - EP         | GU10 - LED FLAT OPTIC (NOT INCLUDED) | 5 W  | 230V  | 55 | A-G |
| QBG1D220EP  | 10 CM 1 SPOT - EP         | GU10 - LED FLAT OPTIC (NOT INCLUDED) | 5 W  | 230V  | 55 | A-G |
| QBG2D220EP  | 10 CM 2 SPOT - EP         | GU10 - LED FLAT OPTIC (NOT INCLUDED) | 5 W  | 230V  | 55 | A-G |
| QB301D230A  | 30 CM 1 SPOT - ANTHRACITE | GU10 - LED FLAT OPTIC (NOT INCLUDED) | 5 W  | 230V  | 55 | A-G |
| QB302D230A  | 30 CM 2 SPOT - ANTHRACITE | GU10 - LED FLAT OPTIC (NOT INCLUDED) | 5 W  | 230V  | 55 | A-G |
| QB601D230A  | 60 CM 1 SPOT - ANTHRACITE | GU10 - LED FLAT OPTIC (NOT INCLUDED) | 5 W  | 230V  | 55 | A-G |
| QB602D230A  | 60 CM 2 SPOT - ANTHRACITE | GU10 - LED FLAT OPTIC (NOT INCLUDED) | 5 W  | 230V  | 55 | A-G |
| QBG1D230A   | 10 CM 1 SPOT - ANTHRACITE | GU10 - LED FLAT OPTIC (NOT INCLUDED) | 5 W  | 230V  | 55 | A-G |
| QBG2D230A   | 10 CM 2 SPOT - ANTHRACITE | GU10 - LED FLAT OPTIC (NOT INCLUDED) | 5 W  | 230V  | 55 | A-G |

ADJUSTABLE ANGLE 270°  
INSTALLATION OPTION: JUB6525





Q-BIC 30 CM 1 SPOT ANTHRACITE

# Q-BIC WALL

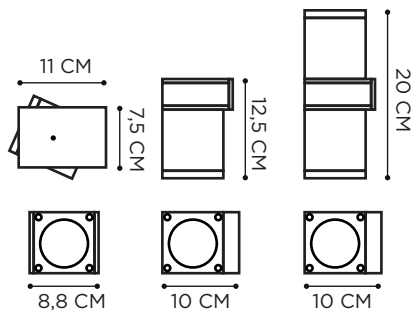

TEAK



ELECTROPOLISHED STAINLESS STEEL



POWDER COATED ALUMINIUM: ANTHRACITE



| REFERENCE  | DESCRIPTION              | LIGHTBULB SOCKET                     | WATT | INPUT | IP | EEC |
|------------|--------------------------|--------------------------------------|------|-------|----|-----|
| QBW1D220EP | 1 SPOT - EP              | GU10 - LED FLAT OPTIC (NOT INCLUDED) | 5 W  | 230V  | 55 | A-G |
| QBW2D220EP | 2 SPOTS - EP             | GU10 - LED FLAT OPTIC (NOT INCLUDED) | 5 W  | 230V  | 55 | A-G |
| QBWVD220EP | 1 SPOT 270° - EP         | GU10 - LED FLAT OPTIC (NOT INCLUDED) | 5 W  | 230V  | 55 | A-G |
| QBWVD230A  | 1 SPOT 270° - ANTHRACITE | GU10 - LED FLAT OPTIC (NOT INCLUDED) | 5 W  | 230V  | 55 | A-G |

QBWVD220EP: ADJUSTABLE ANGLE 270° - GROUND MOUNTING IS ALSO POSSIBLE

QBWVD230A: ADJUSTABLE ANGLE 270° - GROUND MOUNTING IS ALSO POSSIBLE





Q-BIC WALL 1 SPOT 270° ELECTROPOLISHED STAINLESS STEEL







Q-BIC WALL 2 SPOTS ELECTROPOLISHED STAINLESS STEEL

# ROPY

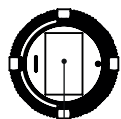

SOLAR LIGHT

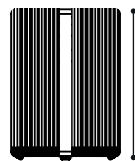

40 CM







Ø 29 CM

POWDER COATED ALUMINIUM: ANTHRACITE/GREEN/PEBBLE



POLYOLEFIN ROPE: BRONZE/GREEN/DESERT



| REFERENCE | DESCRIPTION  | INTEGRATED LIGHT | WATT  | K    | LM  | INPUT | IP | EEC |   |
|-----------|--|------------------|-------|------|-----|-------|----|-----|---|
| RPY040AB  |  BRONZE | SOLAR LED        | 3,2 W | 2700 | 400 | 230V  | 54 | A   |  |
| RPY040GG  |  GREEN  | SOLAR LED        | 3,2 W | 2700 | 400 | 230V  | 54 | A   |  |
| RPY040PBD |  DESERT | SOLAR LED        | 3,2 W | 2700 | 400 | 230V  | 54 | A   |  |





ROPY ANTHRACITE COATED WITH BRONZE POLYOLEFIN ROPE

# ROPY TABLE

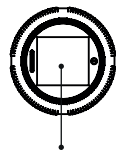

SOLAR LIGHT

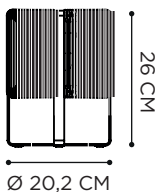







POWDER COATED ALUMINIUM: ANTHRACITE/GREEN/PEBBLE



POLYOLEFIN ROPE: BRONZE/GREEN/DESERT



| REFERENCE | DESCRIPTION  | INTEGRATED LIGHT | WATT  | K    | LM  | INPUT | IP | EEC   |
|-----------|--|------------------|-------|------|-----|-------|----|---|
| RPYTBAB   |  BRONZE | SOLAR LED        | 1,2 W | 2700 | 150 | 230V  | 54 | A  |
| RPYTBGG   |  GREEN  | SOLAR LED        | 1,2 W | 2700 | 150 | 230V  | 54 | A  |
| RPYTBPD   |  DESERT | SOLAR LED        | 1,2 W | 2700 | 150 | 230V  | 54 | A  |





ROPY TABLE PEBBLE COATED WITH DESERT POLYOLEFIN ROPE









# RUSTY

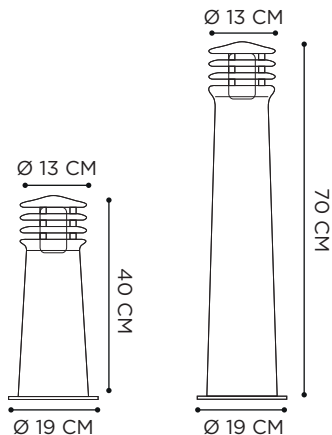

RUSTY IRON



| REFERENCE        | DESCRIPTION | LIGHTBULB SOCKET                | WATT     | K    | LM  | INPUT | IP | EEC |
|------------------|-------------|---------------------------------|----------|------|-----|-------|----|-----|
| RUS40            | 40 CM       | E27 - LED / FLUO (NOT INCLUDED) | MAX 11 W |      |     |       | 55 | A-G |
| RUS70            | 70 CM       | E27 - LED / FLUO (NOT INCLUDED) | MAX 11 W |      |     |       | 55 | A-G |
| INTEGRATED LIGHT |             |                                 |          |      |     |       |    |     |
| RUS40L           | 40 CM       | LED                             | 9 W      | 3000 | 470 | 230V  | 55 | G   |
| RUS70L           | 70 CM       | LED                             | 9 W      | 3000 | 470 | 230V  | 55 | G   |

LED INCLUDES 250mA DRIVER  
 INSTALLATION OPTION: JUB5625





RUSTY 40 CM - ALURA LOUNGE - CONIX 40 SIDE TABLE - RUG 2535 GREEN

# SEPTEM



15,7 CM

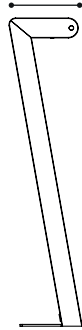

12 CM



70 CM

TEAK



| REFERENCE | INTEGRATED LIGHT | WATT | K    | LM  | INPUT    | IP | EEC   |
|-----------|------------------|------|------|-----|----------|----|---|
| SEP070W   | LED              | 3 W  | 2700 | 450 | 100-240V | 65 | C  |

ADJUSTABLE SPOT 10°

INCLUDES 350mA DRIVER





# SPIKY

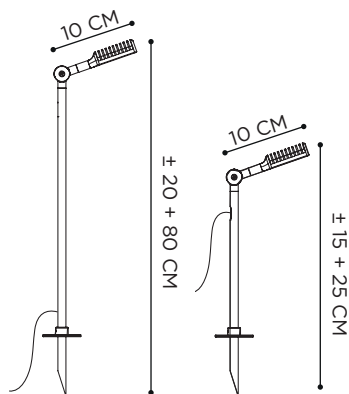

ANTIQUE BRASS



| REFERENCE | DESCRIPTION | INTEGRATED LIGHT | WATT | K    | LM  | INPUT | IP | EEC |
|-----------|-------------|------------------|------|------|-----|-------|----|-----|
| SPKG      | 40 CM       | LED              | 3 W  | 2700 | 450 | 230V  | 65 | A   |
| SPK       | 100 CM      | LED              | 3 W  | 2700 | 450 | 230V  | 65 | A   |

REQUIRED: LEDCONKIT OR DR11





# SPOTTY

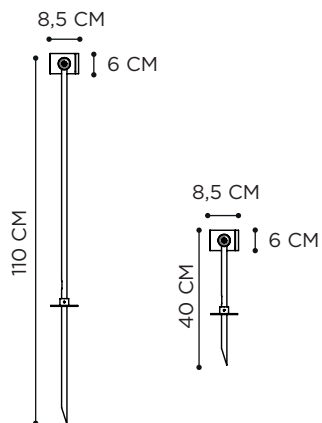

WEATHERED BRASS



| REFERENCE    | DESCRIPTION | LIGHTBULB SOCKET                     | WATT | INPUT | IP | EEC |
|--------------|-------------|--------------------------------------|------|-------|----|-----|
| SPT230L040WB | 40 CM       | GU10 - LED FLAT OPTIC (NOT INCLUDED) | 5 W  | 230V  | 65 | A-G |
| SPT230L110WB | 110 CM      | GU10 - LED FLAT OPTIC (NOT INCLUDED) | 5 W  | 230V  | 65 | A-G |













# TESLA CEILING

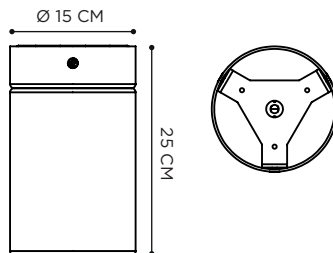

POWDER COATED ALUMINIUM: ANTHRACITE



MOUTHBLOWN GLASS: CLEAR/SMOKE



| REFERENCE | DESCRIPTION | LIGHTBULB SOCKET              | WATT | K    | LM  | INPUT | IP | EEC |
|-----------|-------------|-------------------------------|------|------|-----|-------|----|-----|
| TSLCA     | CLEAR       | E27 - DECORATIVE LED INCLUDED | 4 W  | 2200 | 280 | 230V  | 43 | A-G |
| TSLCASM   | SMOKE       | E27 - DECORATIVE LED INCLUDED | 4 W  | 2200 | 280 | 230V  | 43 | A-G |





TESLA CEILING WITH CLEAR GLASS

# TESLA WALL

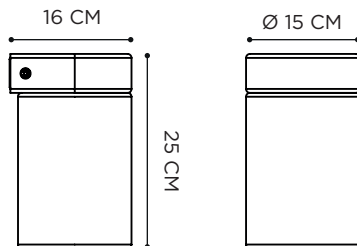





POWDER COATED ALUMINIUM: ANTHRACITE



MOUTHBLOWN GLASS: CLEAR/SMOKE



| REFERENCE | DESCRIPTION   | LIGHTBULB SOCKET              | WATT | K    | LM  | INPUT | IP | EEC   |
|-----------|---|-------------------------------|------|------|-----|-------|----|---|
| TSLWA     |  CLEAR | E27 - DECORATIVE LED INCLUDED | 4 W  | 2200 | 280 | 230V  | 43 | A-G  |
| TSLWASM   |  SMOKE | E27 - DECORATIVE LED INCLUDED | 4 W  | 2200 | 280 | 230V  | 43 | A-G  |





TESLA WALL WITH SMOKE GLASS - CONIX 150V DINING TABLE - OSTREA 55 DINING CHAIR - ROPY TABLE PEBBLE COATED WITH DESERT POLYOLEFIN ROPE









# TRISTAR

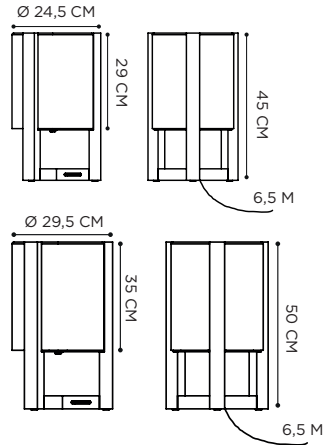

TEAK



POWDER COATED ALUMINIUM: ANTHRACITE/WHITE



MOUTHBLOWN GLASS: CLEAR/SMOKE



| REFERENCE  | DESCRIPTION                | LIGHTBULB SOCKET              | WATT | K    | LM  | INPUT | IP | EEC |
|------------|----------------------------|-------------------------------|------|------|-----|-------|----|-----|
| TRS045CL   | 45 CM - TEAK - CLEAR       | E27 - DECORATIVE LED INCLUDED | 4 W  | 2200 | 280 | 230V  | 43 | A-G |
| TRS045SM   | 45 CM - TEAK - SMOKE       | E27 - DECORATIVE LED INCLUDED | 4 W  | 2200 | 280 | 230V  | 43 | A-G |
| TRS050CL   | 50 CM - TEAK - CLEAR       | E27 - DECORATIVE LED INCLUDED | 4 W  | 2200 | 280 | 230V  | 43 | A-G |
| TRS050SM   | 50 CM - TEAK - SMOKE       | E27 - DECORATIVE LED INCLUDED | 4 W  | 2200 | 280 | 230V  | 43 | A-G |
| TRS045ACL  | 45 CM - ANTHRACITE - CLEAR | E27 - DECORATIVE LED INCLUDED | 4 W  | 2200 | 280 | 230V  | 43 | A-G |
| TRS045WRCL | 45 CM - WHITE - CLEAR      | E27 - DECORATIVE LED INCLUDED | 4 W  | 2200 | 280 | 230V  | 43 | A-G |
| TRS045ASM  | 45 CM - ANTHRACITE - SMOKE | E27 - DECORATIVE LED INCLUDED | 4 W  | 2200 | 280 | 230V  | 43 | A-G |
| TRS045WRSM | 45 CM - WHITE - SMOKE      | E27 - DECORATIVE LED INCLUDED | 4 W  | 2200 | 280 | 230V  | 43 | A-G |
| TRS050ACL  | 50 CM - ANTHRACITE - CLEAR | E27 - DECORATIVE LED INCLUDED | 4 W  | 2200 | 280 | 230V  | 43 | A-G |
| TRS050WRCL | 50 CM - WHITE - CLEAR      | E27 - DECORATIVE LED INCLUDED | 4 W  | 2200 | 280 | 230V  | 43 | A-G |
| TRS050ASM  | 50 CM - ANTHRACITE - SMOKE | E27 - DECORATIVE LED INCLUDED | 4 W  | 2200 | 280 | 230V  | 43 | A-G |
| TRS050WRSM | 50 CM - WHITE - SMOKE      | E27 - DECORATIVE LED INCLUDED | 4 W  | 2200 | 280 | 230V  | 43 | A-G |

CORD LENGTH 6,5 METER





TRISTAR 50 & 45 CM TEAK WITH SMOKE GLASS













TRISTAR 50 & 45 CM TEAK WITH CLEAR GLASS

# ACCESSORIES

|  |   |   |
|--|---|---|
| LBF  | STAINLESS STEEL SPIKE: FUNGY  |   |
| LBN  | STAINLESS STEEL SPIKE: Q-BIC 30/60 / SEPTEM   |   |
| LBQ  | STAINLESS STEEL SPIKE: Q-BIC GROUND / Q-BIC WALL                                    |   |
| LBD  | GALVANISED STEEL SPIKE: DOME FLOOR  |   |
| LBDM   | GALVANISED STEEL SPIKE: DOME MOVE   |   |
| LBR  | GALVANISED STEEL SPIKE: RUSTY   |   |
| BL360  | PERFORATED SCREEN 360° - STAINLESS STEEL  |   |
| BL180  | PERFORATED SCREEN 180° - STAINLESS STEEL  |   |
| BINLS  | LED INSERT FOR NEW OR REPLACEMENT FIXTURES (LED 8,5W - 470lm - 3000K - 230V / 50Hz) | CE  IP55 |
| BIN2   | E27 LAMP HOLDER - 220V/E27 - LED FLUO MAX 11W                                       | CE  IP55 |
| BINLG9   | G9 LAMP HOLDER - 230V/G9 - LED ONLY MAX 5W  | CE  IP55 |
| <b>LEDCONKIT</b>   | <b>= DR11 + JUB5625 + JUB5630</b>   |   |
| DR11   | IP68 LED DRIVER 100-220V 50-60HZ - 350mA - 9W                                       | CE IP68   |
| JUB5625  | CONNECTION BOX IP68 - 3X4 mm <sup>2</sup>   | CE IP68   |
| JUB5630  | JUNCTION BOX IP68 - 2X1,5 mm <sup>2</sup>   | CE IP68   |
| <b>OPTIONAL BULB FOR TESLA / CLOCHE WALL / LUNIZ / MEDUZ / TRISTAR / DOME COLLECTION</b> |   |   |
| LTLED04WE27  | LED FILAMENT BULB 4W - 220V/E27 - 2200K - 280lm                                     | CE     |



# MATERIALS

## TEAK

ROYAL BOTANIA USES CAREFULLY SELECTED, FULLY GROWN TEAK IN ITS PRODUCTS. THE WOOD COMES FROM THE TECTONA GRANDIS TREE AND IS HARVESTED IN ACCORDANCE WITH ENVIRONMENTAL STANDARDS. TEAK IS DURABLE BECAUSE IT CONTAINS HIGH LEVELS OF NATURAL OILS, WHICH PREVENT MOISTURE ABSORPTION AND WARPING. IT IS ALSO RESISTANT TO CHEMICALS AND VERMIN. THESE QUALITIES MAKE TEAK THE MOST PREMIUM WOOD ON EARTH.

TEAK  
REF: W

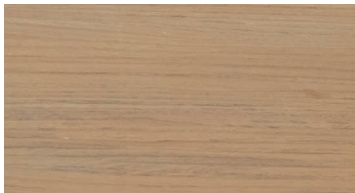

## ELECTROPOLISHED STAINLESS STEEL

ELECTROPOLISHED STAINLESS STEEL FROM ROYAL BOTANIA IS HIGHLY RESISTANT TO CORROSION. THIS IS BECAUSE THE ELECTROPOLISHING PROCESS REMOVES IMPURITIES AND DEFECTS FROM THE SURFACE OF THE STEEL, CREATING A SMOOTH AND UNIFORM SURFACE THAT IS RESISTANT TO CORROSION. THE PROCESS ALSO INCREASES THE THICKNESS OF THE PROTECTIVE CHROMIUM OXIDE LAYER ON THE STEEL'S SURFACE. THE STEEL IS ALSO MORE DURABLE AND LESS LIKELY TO CRACK OR WARP BECAUSE THE ELECTROPOLISHING PROCESS REMOVES ANY RESIDUAL STRESS IN THE STEEL. THIS MAKES IT AN OPTIMAL CHOICE FOR USE IN OUTDOOR ENVIRONMENTS. THE ELECTROPOLISHING PROCESS CREATES A HIGHLY CORROSION-RESISTANT STAINLESS STEEL THAT IS DURABLE AND LONG-LASTING.

ELECTROPOLISHED STAINLESS STEEL  
REF: EP



## POWDER COATED ALUMINIUM

OUR POWDER COATED ALUMINIUM IS PERFECT FOR OUTDOOR LIGHTING BECAUSE IT IS STRONG, LIGHTWEIGHT, AND RESISTANT TO CORROSION. THE POWDER COATING PROCESS CREATES A DURABLE, EASY-TO-CLEAN SURFACE THAT CAN WITHSTAND EXPOSURE TO THE ELEMENTS. THIS MAKES IT AN IDEAL MATERIAL FOR OUTDOOR LIGHTING FIXTURES.

WHITE  
REF: WR

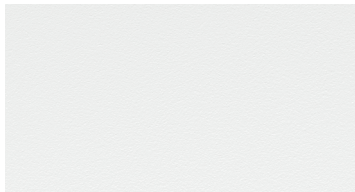

ANTHRACITE  
REF: A

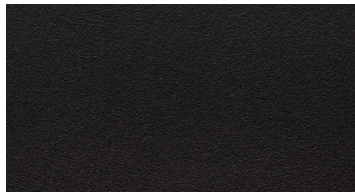

PEBBLE  
REF: PB

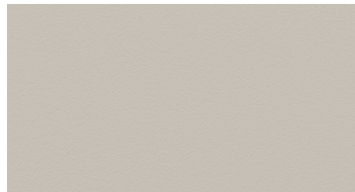

GREEN  
REF: G

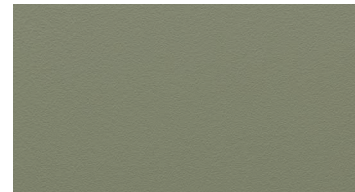

## RUSTY IRON

ROYAL BOTANIA USES A CAST IRON ALLOY WITH A SMALL PERCENTAGE OF COPPER AND CHROME. THIS PREVENTS ANY LAYER OF OXIDATION CREATED BY CONTACT WITH AIR AND WATER FROM FLAKING OFF. THE RESULT IS AN EVEN, RUST-COLOURED PATINA THAT BLENDS IN PERFECTLY WITH THE NATURAL SURROUNDINGS.

RUSTY IRON

REF: RI



## GLASS

ROYAL BOTANIA OFFERS TWO VARIETIES OF COLORED GLASS: CLEAR AND SMOKE, BOTH HANDMADE AND HIGHLY SUITABLE FOR OUTDOOR USE.

CLEAR

REF: CL



SMOKE

REF: SM



## BRASS

BRASS IS A METALLIC ALLOY COMPOSED OF COPPER AND ZINC. THE ANTIQUE BRASS FINISH IS ACHIEVED THROUGH A PROCESS OF ACID DIPPING, WHICH GIVES THE BRASS A DARK, AGED APPEARANCE. THIS FINISH IS WIDELY SOUGHT AFTER FOR ITS UNIQUE, VINTAGE LOOK.

ANTIQUÉ BRASS

REF: AB

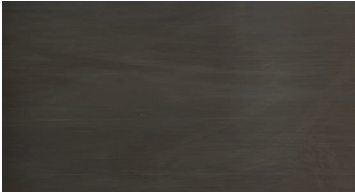

WEATHERED BRASS

REF: WB





## ZINC

THE ZINC ALLOY USED TO MANUFACTURE ROYAL BOTANIA LIGHTING WILL LOOK WHITE IN COLOUR WHEN FIRST INSTALLED IN THE LANDSCAPE. THIS IS DUE TO THE ACIDIFICATION OF THE ZINC OXIDE. AT A LATER STAGE, THIS WHITE DEPOSIT WILL WASH OFF AND WILL TURN INTO A LOVELY DARKGREY PATINA.

ZINC  
REF: Z



## PORCELAIN

PORCELAIN, REFINED AND PRODUCED WITH MODERN AND SOPHISTICATED TECHNIQUES REMAINS STABLE IN ALL TEMPERATURES. IT'S EXTREMELY HARD, WEAR-RESISTANT AND COLORFAST. THIS SUSTAINABLE AND LIFELONG PORCELAIN IS VERY SUITABLE FOR INDOOR- AND OUTDOOR USE.

WHITE  
REF: W



BLACK  
REF: B



NIGHT BLUE  
REF: NB



## POLYOLEFIN

THIS SYNTHETIC FIBRE WHICH IS MADE FROM POLYETHYLENE, OFFERS NUMEROUS BENEFITS. THESE INCLUDE EXCEPTIONAL STRENGTH, COLOR FASTNESS, AND RESISTANCE TO STAINING AND VARIOUS WEATHER CONDITIONS. ITS DURABILITY AND VERSATILITY MAKE IT AN EXCELLENT CHOICE FOR A WIDE RANGE OF APPLICATIONS.

BRONZE  
REF: ...B - POLYPROPYLENE

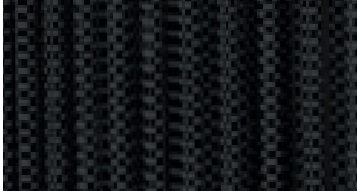

GREEN  
REF: ...G - POLYPROPYLENE



DESERT  
REF: ...D - POLYPROPYLENE

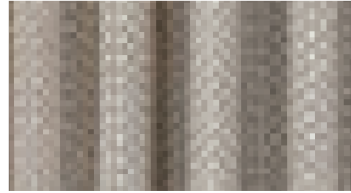

## FABRICS

ROYAL BOTANIA SOURCES ONLY THE FINEST QUALITY TEXTILES FROM AROUND THE WORLD, METICULOUSLY SELECTING MATERIALS THAT ARE BOTH SUMPTUOUS TO THE TOUCH AND CAPABLE OF WITHSTANDING THE ELEMENTS, RESULTING IN A PRODUCT THAT IS BOTH LUXURIOUS AND PRACTICAL.

VIEW THEM BY SCANNING THE QR CODE BELOW!





## CERAMIC

THE CERAMIC TOPS ARE MADE FROM NATURAL CLAYS, SO SMALL COLOUR GRADATIONS CAN OCCUR. THIS MAKES EACH TABLE UNIQUE.

WHITE  
REF: WUM



CEMENTO LUMINOSO  
REF: CL



PEARL GREY  
REF: PG



NERO MARQUINA  
REF: NM

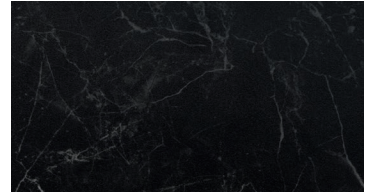

BIANCO STATUARIO  
REF: BS



TRAVERTINO  
REF: TR

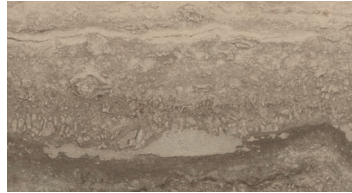

TAUPE GREY  
REF: TG



BLACK  
REF: ZUM



CEPPO DOLOMITICA  
REF: CD

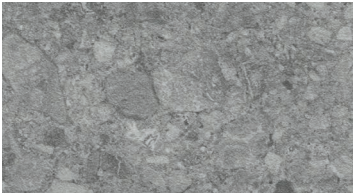

TERRA SABBIA  
REF: TS

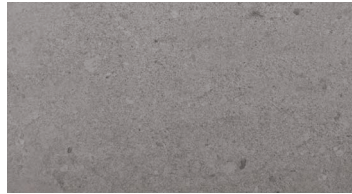

TERRA MARRONE  
REF: TM



# FURNITURE & PLANTER CATALOGUE

ASK YOUR DEALER FOR THE COMPLETE OUTDOOR FURNITURE & PLANTER CATALOGUE  
OR DOWNLOAD THEM ON OUR WEBSITE: [WWW.ROYALBOTANIA.COM](http://WWW.ROYALBOTANIA.COM)

VIEW THEM HERE

