

Zava
celebrate
colours

Celebriamo i nostri primi 40 anni di attività
presentandoci con un'immagine rinnovata,
dove la cromia diventa interprete del
nostro tempo e la narrazione si estende in
un avvicinarsi di episodi "colorati",
capaci di trasmettere il legame
dell'azienda con i propri designer
attraverso uno scambio continuo di stimoli
e idee ma soprattutto capaci di trasmettere i
valori che ci animano e che ci hanno
aiutato a crescere fino ad oggi.

We celebrate our first 40 years

of activity by presenting ourselves with a renewed image, where colours become the interpreter of our time and the narrative extends into an alternation of colorful episodes, capable of transmitting the company's bond with its designers through a continuous exchange of stimuli and ideas but above all capable of transmitting the values that animate us and that have helped us to grow until today.

p. 11 Azienda | Company

p. 14 Designer

p. 21 Collection

Index

■ New

1962 p. 22



1962 Big p. 24



Atrax p. 46



Berlino p. 52



Dot to dot p. 74



Driyos p. 76



Hook p. 96



Jeena p. 98



Meta p. 128



Mini Mini p. 138



Alvin p. 26

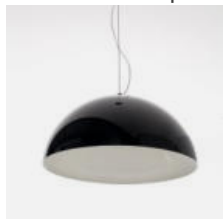

Amedeo p. 28

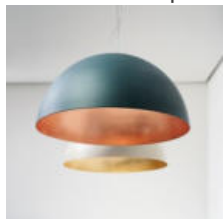

Andromeda p. 36

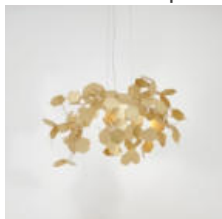

Arianna p. 40



Atom p. 44

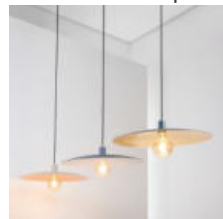

Box p. 54

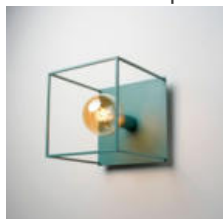

Bull p. 60

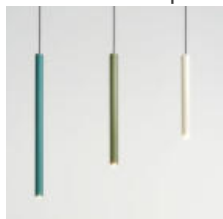

Cantiere p. 62



Cosima p. 70

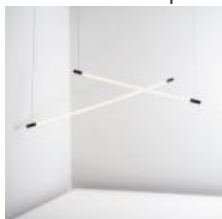

Crack p. 72

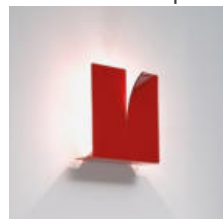

Driyos Naked p. 80



Etrè p. 82

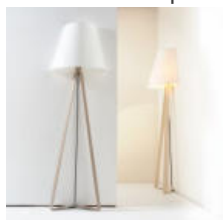

Fenex p. 86

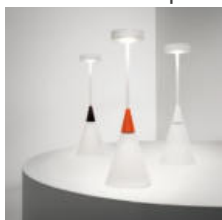

Flamenco p. 90

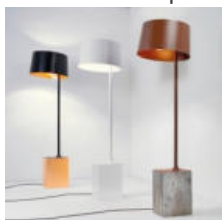

Flow p. 94

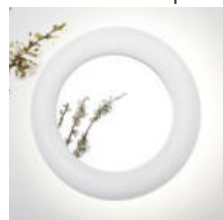

Lady Cage p. 108



Linfa p. 114

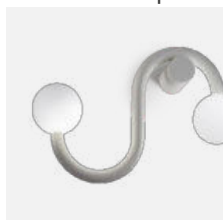

Loola p. 118



Mark p. 124



Meridium p. 126



Nefertari p. 140



Net p. 142

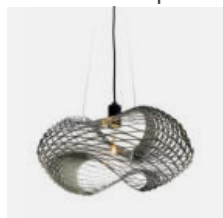

Nox p. 150

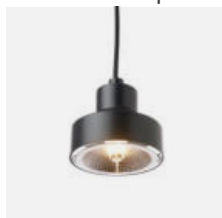

Ociu p. 152



Officina p. 154



Orizzonte p. 156



Pato p. 160

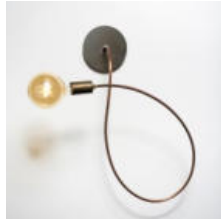

Petit p. 162



Pils p. 166

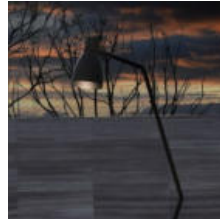

Ph21 p. 170



Queen Cage p. 112



Ragi p. 172



Ragi-T p. 174



Rei p. 178



Rings p. 182



Ronin p. 192



Salvia p. 198



San Babila p. 200



Sister p. 204



Sketch p. 210



Slices-S p. 212



Slices-XL p. 216



Soda p. 218



Sonoluce p. 220

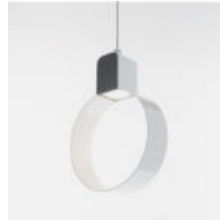

Vox p. 224



Wa p. 226



ZERO2 p. 228



349 p. 232



Concrete p. 234



Dema p. 236

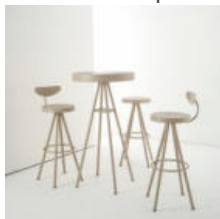

Jooke p. 238



Ragno p. 240

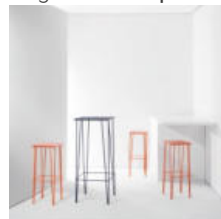

Street p. 242



Tank p. 246



Tico p. 248



Collection

	Sospensione Suspension	Terra Floor	Tavolo Table	Parete Wall light	Plafoniera Ceiling light	Ricaricabile Rechargeable	Esterno Outdoor	Sistema System	Complemento Complement
1962		•							
1962 Big		•							
349									•
Alvin	•								
Amedeo	•	•	•	•					
Andromeda	•	•		•					
Arianna			•	•					
Atom	•								
Atrax		•		•	•				
Berlino	•								
Box		•	•	•	•				•
Bull	•								
Cantiere		•		•	•		•		
Concrete									•
Cosima	•			•	•				
Crack				•					
Dema									•
Dot to dot				•	•		•		
Driyos	•						•		
Driyos Naked	•								
Etrè		•		•					
Fenex						•			
Flamenco		•							
Flow				•					
Hook - sistema								•	
Ideo				•			•		
Jeena	•	•		•					
Jooke									•
Lady Cage	•		•	•			•		
Linfa	•			•					
Loola	•			•	•				
Mark	•								
Meridium				•					
Meta	•	•	•	•	•				
Mini Mini							•		
Nefertari				•	•				
Net	•	•	•						
Nox	•								
Ociu	•								

I flussi luminosi indicati si riferiscono alla sorgente installata nell'apparecchio. È possibile scaricare tutta la documentazione prodotto sul sito www.zavaluce.it, previa registrazione all'area riservata. Tutti gli apparecchi ZAVA con sorgenti integrate LED hanno bisogno di un alimentatore o di un driver per poter funzionare. I LED integrati utilizzati nei prodotti ZAVA non funzionano collegati direttamente alla tensione di rete. Gli alimentatori o driver necessari a trasformare la tensione di rete in tensione costante oppure corrente costante (a seconda del modello) devono sempre essere utilizzati. Il collegamento diretto di una sorgente LED integrata alla tensione di rete è pericoloso per la persona e distrugge all'istante la sorgente luminosa. Fare sempre riferimento alle istruzioni di montaggio fornite dal produttore. Consultare il sito web per i dati tecnici aggiornati.

The luminous fluxes indicated refer to the source installed in the luminaire. Download the product documentation at www.zavaluce.it, by registering in the reserved area. All ZAVA luminaires with integrated LED sources need a power supply or driver to work. The integrated LEDs used in ZAVA products do not work directly connected to the mains voltage. The power supplies or drivers required to convert the mains voltage into constant voltage or constant current (depending on the model) must always be used. Direct connection of an integrated LED source to the mains voltage is dangerous to humans and instantly destroys the light source. Always refer to the assembly instructions provided by the manufacturer. Refer to the website for the latest updated technical informations.

	Sospensione Suspension	Terra Floor	Tavolo Table	Parete Wall light	Plafoniera Ceiling light	Ricaricabile Rechargeable	Esterno Outdoor	Sistema System	Complemento Complement
Officina	•								
Orizzonte	•								
Pato		•		•	•				
Petit	•			•					
Pils							•		
Ph21							•		
Queen Cage	•								
Ragi - sistema								•	
Ragi T - sistema								•	
Ragno									•
Rei		•	•	•					
Rings	•			•	•				
Ronin	•	•		•					
Salvia							•		
San Babila				•					
Sister	•	•	•	•					
Sketch				•					
Slices-S	•	•	•						
Slices-XL	•								
Soda	•								
Sonoluce	•		•	•					
Street									•
Tank									•
Tico									•
Vox	•								
Wa		•							
ZERO2 - sistema								•	



Azienda

Company

ZAVA nasce nel 1982: da allora, l'azienda lavora il metallo grazie alle maestranze artigianali fortemente radicate e connesse ad una continua innovazione tecnologica. Ogni pezzo è espressione di un'insostituibile sapienza artigiana, unita a creatività e attenzione per il design. Sono queste le caratteristiche che contraddistinguono da sempre un Made in Italy basato sulla passione e la valorizzazione delle capacità umane. ZAVA propone quindi una collezione di lampade di indubbia personalità, la cui singolarità sta proprio nell'incontro tra resistenza, matericità e forza espressiva del ferro e la caratteristica leggerezza impalpabile della luce.

ZAVA nasce dal talento creativo e dall'energia visionaria del suo titolare, Franco Zavarise, che nella sua officina ha saputo fondere le più avanzate tecnologie con una sapiente lavorazione artigianale del metallo. ZAVA da sempre crea prodotti di illuminazione e complementi d'arredo i cui tratti distintivi sono qualità, attenzione al design, creatività fuori dagli schemi e grande attenzione al dettaglio. Le collezioni ZAVA sono riconosciute come una vera e propria eccellenza del Made in Italy.

ZAVA was founded in 1982: the company works metal defining its history year after year, thanks to the handcraft skills, strongly connected to a continuous technological innovation. Every article reflects wise craftsmanship, creativity and careful design. These are the aspects that define an italian made product as well as the passion and regard for true artisan talent. ZAVA offers a unique lighting collection whose peculiarity is the result of the combination between iron's material consistency and resistance and the light's impalpable weightlessness.

ZAVA was created thanks to the founder, Franco Zavarise's creative talent and visionary energy: in his workshop he was able to combine advanced technology and wise craftsmanship in metalwork. From the very start, ZAVA has created lighting products and furnishings that are distinguished by high quality and design, creativity and attention to detail. The ZAVA collections are recognized for their true italian made excellency.

Sostenibilità

Sustainability

ZAVA è un'azienda fortemente radicata nella tradizione manifatturiera del suo territorio e visceralmente legata a valori di rispetto, conservazione e cura di quell'ambiente unico in cui l'azienda si è sviluppata, la provincia di Treviso. È per questo che, con la passione e la caparbia che contraddistinguono i grandi progetti, nel 2010 ZAVA porta a compimento uno stabilimento all'avanguardia dove creare i propri prodotti nel più profondo rispetto per l'ambiente e per la qualità del lavoro; un laboratorio costruito secondo i più innovativi criteri di eco-sostenibilità, di risparmio e di autosufficienza energetica. Valori che ZAVA ha fatto propri con grande concretezza e sensibilità investendo nella predisposizione di pannelli fotovoltaici, nell'autoproduzione e nel riciclo dell'energia termica. Tutta la filiera produttiva di ZAVA è all'insegna di scelte etiche e ambientali importanti: i processi di lavorazione del metallo non contemplano l'uso di sostanze tossiche o acide. Per questi motivi, inoltre, ZAVA da sempre pone grande attenzione alla sostenibilità dei suoi prodotti e alla salvaguardia dell'ambiente, anche nei più piccoli dettagli; i packaging degli articoli, infatti, sono realizzati al 100% con materiali riciclabili, di cui il 98% completamente biodegradabili: carta, cartone e paglia.

ZAVA is a company strongly rooted in the manufacturing tradition of its territory and strongly linked to values of respect, conservation and care of the unique environment in which we are living and in which the company has been founded. That is why, with the passion that is characterising the big projects, in 2010 ZAVA brought into completion the opening of a state-of-the-art company, where the products are manufactured in the utmost respect for the environment and the highest quality of working processes. The company is built using the most innovative criteria of eco-sustainability, savings and self-sufficiency energy, by using photovoltaic panels and the recycling of thermal energy. All ZAVA's production chain is characterized by important ethical and environmental choices: the metal processes does not cover the use of toxic or acidic substances. The packaging for all the articles, is made of 100% recyclable materials, of which 98% completely biodegradable: paper, cardboard and straw.



Designer

Da alcuni anni ZAVA condivide la sua visione e la sua idea della luce con diversi designer, compagni di strada e interpreti del mondo e della filosofia aziendale.

For several years ZAVA has been sharing his vision and his ideas of light with different designers, traveling partners and interpreters of the ZAVA's world and philosophy.

Alberto Ghirardello



Nasce a Vicenza nel 1985. Dopo la laurea in Disegno Industriale allo I.U.A.V. di Venezia nel 2007, collabora con lo studio Bartoli Design e dal 2010 al 2013 lavora nello studio di Giulio Iacchetti. Nello stesso anno fonda il proprio studio di progettazione, occupandosi di design a 360° e collaborando con numerose aziende, sia italiane che estere. I suoi lavori sono stati pubblicati ed esposti in svariate riviste del settore.

He was born in 1985 in Vicenza. After gaining his Industrial Design bachelor degree at I.U.A.V. University of Venice in 2007, he had a six months internship at Bartoli Design studio. From 2010 to 2013 he had been working for Giulio Iacchetti's design studio. In 2013 he founded his own design studio, working on the full spectrum of design and collaborating with several companies.

Andrea Brugnera



Andrea Brugnera lavora a Treviso. Con la tesi "L'arredo in cartone alveolare" unisce l'ecologia industriale al design, realizzando progetti in cartone come stand al Pitti. Collabora con Luciano Bertoncini dal 2004 e nel 2009 avvia l'attività di designer, vincendo concorsi e disegnando per diversi marchi. Nel 2015 viene selezionato per il premio Young&Design ed espone in una collettiva alla Triennale di Milano.

Andrea Brugnera works in Treviso. With the thesis "The honeycomb cardboard furniture" manages to combine industrial ecology to the design, creating projects as cardboard stand at Pitti. He collaborated with Luciano Bertoncini since 2004 and in 2009 started working as a designer, winning competitions and designing for several brands. In 2015 he was selected for the prize Young & Design and exhibited in a group show at the Milan Triennale.

Alberto Caramello



Torinese, si laurea in Architettura al Politecnico di Torino, avvicinandosi al product design. Dopo aver lavorato come designer freelance, fonda nel 2008 l'azienda StudioACD. Diversi i suoi prodotti di successo sul mercato e le collaborazioni con aziende a livello globale come consulente di sviluppo prodotto. Dal 2009 è professore alla Design University di Torino e occasionalmente invitato a tenere seminari sul problem solving creativo.

Born in Turin, he graduated in Architecture at the Polytechnic of Turin, approaching to product design world. After working as a freelance designer, he founded StudioACD in 2008. Several of his successful products are now on the market; he also has several collaborations with global companies as a product development consultant. Since 2009 he is a professor at IAAD, the Design University of Turin and occasionally invited to hold seminars on creative problem solving.

BrogliatoTraverso



Alberto Brogliato e Federico Traverso fondano BrogliatoTraverso design nel 2012, dopo varie collaborazioni progettuali. La convinzione che poter dar vita agli oggetti che circondano le persone sia un gran privilegio, e la costante passione per ricerca ed innovazione, hanno permesso a BrogliatoTraverso di ricevere vari riconoscimenti internazionali, tra i quali Red Dot Design Award, Good Design Award, iF Design Award, A' Design Award, Young&Design.

Alberto Brogliato and Federico Traverso based BrogliatoTraverso design in 2012, after various project collaborations. The belief that you can give life to the objects that surround people is a great privilege, and the constant passion for research and innovation, have allowed BrogliatoTraverso to receive several international awards, including the Red Dot Design Award, Good Design Award, iF Design Award, A 'Design Award, Young & Design.

Lorenzo Palmeri



In veste di art director ha seguito vari progetti, tra questi Invicta, Lefel (progetto di design dell'editore Feltrinelli), Arthemagroup, Stone Italiana. Tra i principali clienti: Valenti Luce, Arthemagroup, Garofoli, Andreoli, Guzzini. Si occupa di didattica dal 1997. I suoi progetti hanno vinto importanti premi nazionali ed internazionali. Nel 2017 è stato nominato tra gli "Ambasciatori del Design Italiano" nell'ambito dell'Italian Design Day.

As an art director he has followed various projects, including Invicta, Lefel (design project for the publisher Feltrinelli), Arthemagroup, Stone Italiana. Among the main customers: Valenti Luce, Arthemagroup, Garofoli, Andreoli, Guzzini. He has been teaching since 1997. His projects have won important national and international awards. In 2017 he was named among the "Ambassadors of Italian Design" in the context of the Italian Design Day.

C12+



C12+ è un progetto collaterale del collettivo torinese C12, attivo dal 2007 nell'ambito del design autoprodotta e di ricerca. C12+ è oggi Anita Donna Bianco, fondatrice di C12, e Gianni Colonello, automotive e industrial designer. Entrambi architetti per formazione e designer per passione, collaborano su progetti che fondono i loro percorsi.

C12+ is a spinoff program of the Torino based C12 work group, founded in 2007 and active in self produced design and design research. C12+ is formed by Anita Donna Bianco, C12 co-founder, and Gianni Colonello, automotive and industrial designer. Both architect and designer for passion, they collaborate on programs merging their paths.

Alessandro Zambelli



Alessandro Zambelli vive e lavora a Mantova. Si specializza in Disegno Industriale e Tecnica dei Materiali presso la Fondazione Cova di Milano e nel 2000 inizia la sua attività professionale con Agape. Nel 2003 nasce Alessandro Zambelli Design Studio. Si aggiudica l'European Consumer Choice 2011 e NYIGF Award 2012, ADI Design Index 2014 e Premio per l'Innovazione ADI, Interior Innovation Award 2015.

Alessandro Zambelli lives and works in Mantua. He specialized in Industrial Design and Technology of Materials at Fondazione Cova in Milan and in 2000 he began his professional career with Agape. In 2003 he created Alessandro Zambelli Design Studio. He is the winner of the European Consumer Choice Award NYIGF 2011 and 2012, ADI Design Index 2014 Award for Innovation ADI, Interior Innovation Award 2015.

Cédric Davies



Cédric Davies ha lavorato come addetto alle produzioni cinematografiche e televisive dove ha sviluppato la sua passione per le luci e le soluzioni di illuminazione. Nel 2006 ha fondato a Monaco di Baviera una società di installazioni elettriche, seguita nel 2013 da DAVIES GmbH, specializzata in consulenza e progettazione illuminotecnica. Questa sinergia tra installazione e progettazione crea sistemi di illuminazione progettati professionalmente, appositamente studiati su misura per le esigenze dei clienti.

Cédric Davies worked as a gaffer for film and tv productions where he developed his passion for lights and lighting solutions. In 2006 he founded a firm for electric installations in Munich, followed in 2013 by DAVIES GmbH, specialized in light consulting and design. This synergy between installation and design creates professionally designed lighting systems, specially tailored for the needs of his customers.

Paolo Ulian



Industrial designer toscano di origine, nei primi anni '90 è a Milano per lavorare con Enzo Mari. Ha vinto il "Design Report" Award e il premio "Dedalus". Collabora con Droog Design e con alcune aziende italiane tra le quali Antoniolumi, Driade, Fontana Arte, Zani e Zani, BBB Bonacina, Sensi&C., Coop, Skitsch.

Industrial designer of Tuscan origin. In the early '90's he was in Milan working with Enzo Mari. He won the "Design Report" Award and the "Dedalus" award as well. He works together with Droog Design and with Italian companies such as Antoniolumi, Driade, Fontana Arte, Zani e Zani, BBB Bonacina, Sensi&C., Coop and Skitsch.

BMB Progetti

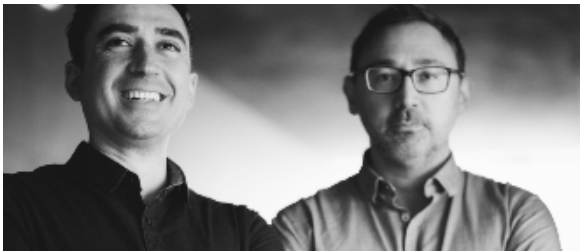

Bellucci Mazzoni Progetti è lo studio di interior design fondato nel 2012 dai designer Guido Bellucci e Francesco Mazzoni. Nato con ragione sociale BMB Progetti è solo nel 2023 che cambia nome in Bellucci Mazzoni Progetti. Lo studio di industrial design nasce con l'obiettivo di dare ampio respiro a fantasia e creatività trasformandoli nei valori sulla base dei quali realizzare progetti dal forte impatto grafico e contemporaneo.

Bellucci Mazzoni Progetti is the interior design studio founded in 2012 by designers Guido Bellucci and Francesco Mazzoni. Born with the company name BMB Progetti, it was only in 2023 that it changed its name to Bellucci Mazzoni Progetti. The industrial design studio was set up with the aim of giving imagination and creativity a wide range, transforming them into the values on the basis of which to realise projects with a strong graphic and contemporary impact.

Testatonda



Testatonda è un gruppo di progettazione oggi basato a Torino, ma dalle molteplici influenze nella sua identità più profonda: Roma, Milano, Barcellona sono gli scenari metropolitani sociali e culturali di un percorso di formazione e di lavoro in continuo divenire. Il gruppo formato da Nicolò Corigliano, Matteo Minello e Valter Cagna basa la propria ricerca sull'intuitività dell'eleganza e la pluralità delle sue forme, individuando nelle smagliature e nei particolari difformi il criterio di qualsiasi bellezza possibile.

Testatonda is a design group now based in Turin, but with multiple influences in its deepest identity: Rome, Milan, Barcelona are the social and cultural metropolitan scenarios of a training and work path in continuous evolution. The group formed by Nicolò Corigliano, Matteo Minello and Valter Cagna draw inspiration from the intuitiveness of elegance and the plurality of its shapes, identifying the criteria of any possible beauty in gaps and uneven details.

Mariam Ayvazyan



Mariam Ayvazyan è laureata con Master in Architettura e Design dell'Università Statale di Yerevan di Architettura e Costruzione. La sua attenzione è rivolta alla Bio-Architettura, che incorpora l'arte e la scienza in progettazione di edifici e dello spazio. Dal 2003 al 2015 ha collaborato con varie aziende e diversi architetti su progetti internazionali. Dall'Ottobre del 2015 è titolare di uno studio di Architettura e Design: "Made in Love".

Mariam Ayvazyan has a Masters Degree in Architecture & Design from the Yerevan State University of Architecture and Construction. Her focus is in Bio-Architecture which incorporates art and science into design of buildings and space. From 2003 to 2015 has been employed in various firms and collaborated with several architects on international projects. Since October 2015 she is the owner of an Architecture & design studio: "Made In Love".

Debonademeo



Luca De Bona e Dario De Meo fondano nel 2013 a Padova lo studio DEBONADEMEO e iniziano a collaborare con prestigiose aziende di arredo, illuminazione, decorazione occupandosi di interior design, direzione artistica, ideazione di concept e sviluppo di prodotti. Parallelamente all'attività progettuale svolgono entrambi attività didattiche presso scuole e università di settore.

Luca De Bona and Dario De Meo founded the DEBONADEMEO studio in Padua in 2013 and started to collaborate with prestigious furniture, lighting and decoration companies, dealing with interior design, art direction, concept design and product development. Parallel to the project activity they both carry out didactic activities in schools and universities of the sector.

Enrico Azzimonti



Architetto e designer, parallelamente all'attività didattica presso lo IED di Milano e altre Università italiane, collabora con aziende come TVS, Lavazza, Guzzini, Coop, JVC, Diamantini&Domeniconi, Bosa, Pavoni Italia, Deutsche Bank. Alcuni suoi lavori sono esposti presso il "Museu de les Arts Decoratives" di Barcellona.

Architect and designer, while teaching at IED Milan and other Italian universities, he collaborates with company as TVS, Lavazza, Fratelli Guzzini, Coop, JVL, Diamantini&Domeniconi, Bosa, Pavoni Italia, Deutsche Bank. Some of his works are exhibited at the "Museu de les Arts Decoratives" in Barcelona.

Meneghello Paoelli

Associati



Marco Paoelli e Sandro Meneghello, oltre ad essere product designer, si definiscono consulenti strategici per il prodotto industriale. Fondano Meneghello Paoelli Associati a Milano nel 2007. Dal 2007 lo Studio affianca aziende italiane ed estere con il fine di creare valore aggiunto attraverso il design di prodotto quali The.ArtCeram, Arbi Arredobagno, Glass1989, Horm, Fiam, Gibus, Guzzini.

Marco Paoelli and Sandro Meneghello, in addition to being product designers, define themselves as strategic consultants for the industrial product. They founded Meneghello Paoelli Associati in Milan in 2007. Since 2007 the Firm has been supporting Italian and foreign companies with the aim of creating added value through product design such as The.ArtCeram, Arbi Arredobagno, Glass1989, Horm, Fiam, Gibus, Guzzini.

Valerio Cometti v12 design



Laureato in Ingegneria Meccanica al Politecnico di Milano, fonda nel 2005 a Milano lo studio "Valerio Cometti+V12 Design". Collaborazioni: Brionvega (televisori); Leucos (lampade); LaCimbali (macchine caffè); Riva1920 (mobili); Fiam Italia (vetro); Mediaset (elettronica); FEB21st (luxury eyewear). Dal 2009 è columnist di car design per Mondadori.

Valerio Cometti, graduate in Mechanical Engineering at Milan's Polytechnic, establishes in 2005 "Valerio Cometti+V12 Design" in Milan. Collaborations: Brionvega (television); Leucos (lamps); LaCimbali (coffee machines); Riva1920 (furniture); Fiam Italia (glass); Mediaset (electronics); FEB31st (luxury eyewear). Since 2009, Valerio Cometti is car design columnist for Mondadori.

Franco Zavarise



Franco Zavarise nasce a Mareeba, Australia, nel 1960. Dopo gli studi tecnici matura il desiderio di realizzare corpi illuminanti per gli amici di sempre. Nel 1982 fonda ZAVA, una realtà dinamica in continua espansione. Crede nel design bello, accessibile e sostenibile.

Franco Zavarise was born in Mareeba, Australia, in 1960. After finishing his technical studies, he developed his great desire: to create lighting structures for his old friends. In 1982 he founded the dynamic and continuously growing ZAVA. He believes in great, affordable and sustainable design.

Massimo Rosati



Architetto, giornalista e blogger, si occupa da sempre di design e comunicazione. Dopo aver collaborato con i principali editori e aver diretto per 14 anni il mensile LA MIA CASA, ha fondato Designstreet.it, il web magazine dedicato al design contemporaneo. È designer per passione.

Architect, journalist and blogger, always interested in design and communication. Having worked together with the main editors and having directed the monthly LA MIA CASA for 14 years, he founded Designstreet.it, the online magazine dedicated to contemporary design. He is a designer out of passion.

Delineodesign / Giampaolo Allocco



Delineodesign è una innovation design consultancy fondata da Giampaolo Allocco che sviluppa progetti multidisciplinari di industrial design dall'alto valore tecnologico. Aggiudicatosi oltre 20 International Awards, vanta collaborazioni in Formula Uno e MotoGP oltre a numerosi progetti di Product Design con brand quali BMW - Husqvarna, Elite, La Sportiva, Scubapro, Lavazza, Manfrotto, Ifi Industrie, Head, Augusta Westland, ecc.

Delineodesign is an innovation design consultancy founded by Giampaolo Allocco that develops multidisciplinary industrial design projects with a high technological value. Winning over 20 International Awards, it boasts collaborations in F1 as well as numerous product design projects with brands such as BMW - Husqvarna, Elite, La Sportiva, Scubapro, Lavazza, Manfrotto, Ifi Industrie, Head, Augusta Westland, etc.



Collezioni

Collection



1962

Design: Franco Zavarise

Lampada da terra con struttura in metallo verniciato.

Floor lamp with a painted metal structure.

Sorgente luminosa Light source

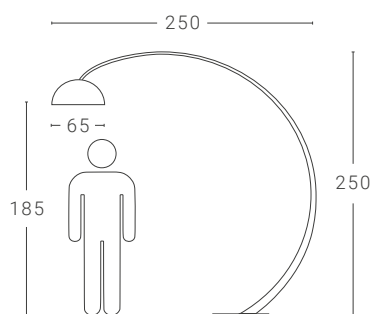

Attacco E27 (lampadina esclusa) Max 105W
Lampholder E27 (bulb not included) Max 105W

LED 1 x 28W 230V 3000K 1950Lm Energy Class A
Driver ON/OFF incluso
Disponibile driver dimmerabile DALI/PUSH su richiesta
ON/OFF driver included
DALI/PUSH dimmable driver available on request

Materiale Material

Ferro
Iron

Finiture esterne Outside colours

○ RAL 9010

● RAL 9005

Finiture disponibili solo in versione opaca
Finishes available only in matt version

Finiture interne Inside colours

Vedi tabella colori.
See colour chart.



1962 Big

Design: Franco Zavarise

Capace di valorizzare e rendere unico ogni ambiente con la sua maestosa eleganza, 1962 Big è un pezzo esclusivo grazie al suo design minimalista, dettato da forme semplici e materiali industriali. Presenta un'importante cupola di 80 cm di diametro, personalizzabile con foglia oro, argento o rame.

Thanks to its majestic and elegance, 1962 Big is an unique piece, capable of enhancing and making any environment where it is set absolutely exclusive. Minimalist and dictated by simple shapes, it has an impressive dome of 80 cm. The inner part of the dome is customizable with an accurate handicraft treatment in gold, silver or copper leaf.

Sorgente luminosa Light source

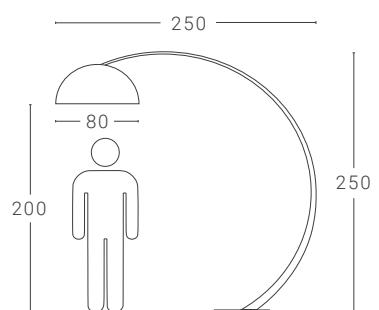

Tecnologia LED a guida di luce
Edge-Lit LED technology :
LED 1 x 36W 3000K 3600Lm CRI>90

Driver dimmerabile DALI/PUSH incluso
DALI/PUSH dimmable driver included

Materiale Material

Ferro, alluminio
Iron, aluminium

Finiture esterne Outside colours

○ RAL 9010 ● RAL 9005

Finiture disponibili solo in versione opaca
Finishes available only in matt version

Finiture interne Inside colours

Vedi tabella colori.
See colour chart.

Finiture cavo Cable colours

● Rayon nero Black rayon



Alvin

Design: Franco Zavarise

Una grande cupola in metacrilato opalino o nero con interno verniciato oppure in foglia oro, argento, rame.

A large dome shape in opal or black methacrylate with a painted interior or in gold, silver, copper leaf.

Sospensione Suspension

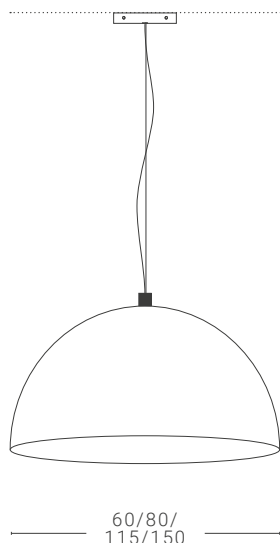

Sorgente luminosa Light source

Ø60/80/115/150 cm:
Attacco E27 (lampadina esclusa) Max 105W
Lampholder E27 (bulb not included) Max 105W

Dim. rosone: Ø 16 cm altezza 5 cm
Ceiling rose dim.: Ø 16 cm height 5 cm

Versione LED on/off dali/push a richiesta
LED on/off dali/push version on request

Materiale Material

Ferro, metacrilato
Ferro, methacrylate

Finiture esterne Outside colours

○ RAL 9010 ○ Bianco opale
Opal white
● RAL 9005 ● Nero opale
Opal black

Finiture disponibili solo in versione opaca
Finishes available only in matt version

Finiture interne Inside colours

Vedi tabella colori.
See colour chart.



Amedeo

Design: Franco Zavarise

Iconica e divertente famiglia di lampade in metallo, disponibile in vari colori e adatta per gli ambienti più diversi.

Iconic and enjoyable metal lamps, available in different colors and suitable for any contemporary surroundings.





Amedeo

Design: Amedeo Mander

Sospensione Suspension

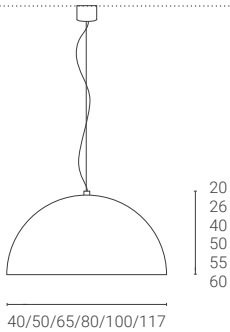

Dim. rosone: Ø 10 cm altezza 6 cm
Ceiling rose dim.: Ø 10 cm height 6 cm

Le dimensioni del rosone nella variante DALI/PUSH possono essere diverse
The dimensions of the ceiling rose in DALI /PUSH variant can be different

Sorgente luminosa Light source

Ø40/50/80/100/117 cm:

Attacco E27 (lampadina esclusa) Max 105W

Lampholder E27 (bulb not included) Max 105W

Ø 40 cm:

LED 1 x 26W 230V 3000K 1950Lm Energy Class A

Ø50/65 cm:

LED 1 x 28W 230V 3000K 1950Lm Energy Class A

Ø80 cm:

LED 1 x 36W 230V 3000K 3060Lm Energy Class A

Driver ON/OFF incluso /

Disponibile driver dimmerabile DALI/PUSH su richiesta

ON/OFF driver included /

DALI/PUSH dimmable driver available on request

Ø 80 cm:

3 x Attacco E27 (lampadine escluse) Max 105W

Versione con diffusore opale nella parte inferiore della cupola

3 x Lampholder E27 (bulbs not included) Max 105W

Version with opal diffuser in the lower part of the dome

Disponibile anche versione outdoor

Outdoor version available

Materiale Material

Ferro, alluminio
Iron, aluminium

Finiture esterne Outside colours

○ RAL 9010

● RAL 9005

● Rosa quarzo
Quartz Pink

● Ruggine naturale
Natural rust

● Sahara

● Blu oceano

● Blu di laminazione
Iron blu

Finiture interne Inside colours

Vedi tabella colori.
See colour chart.

Finiture disponibili solo in versione opaca
Finishes available only in matt version



Amedeo

Design: Franco Zavarise

Terra Floor

Sorgente luminosa Light source

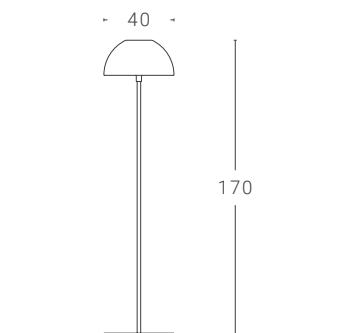

Attacco E27 (lampadina esclusa)
Max 105W
Lampholder E27 (bulb not included)
Max 105W

Tavolo Table

Sorgente luminosa Light source

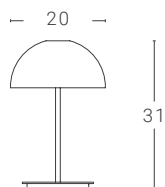





Attacco E14 (lampadina esclusa)
Max 42W
Lampholder E14 (bulb not included)
Max 42W

Materiale Material

Ferro
Iron

Finiture esterne Outside colours

-  RAL 9010
-  RAL 9005
-  Sahara
-  Blu oceano
-  Rosa quarzo Quartz Pink

Finiture disponibili solo in versione opaca
Finishes available only in matt version

Finitura interna Interior colour

Vedi tabella colori.
See colour chart.





Amedeo

Design: Franco Zavarise

Parete Wall light

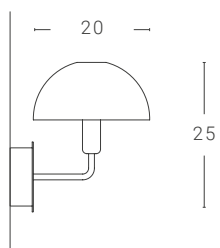

Sorgente luminosa Light source

Attacco E14 (lampadina esclusa)
Max 42W
Lampholder E14 (bulb not included)
Max 42W

Materiale Material

Ferro
Iron

Finiture Colours

- RAL 9010
- RAL 9005
- Rosa quarzo Quartz Pink
- Sahara
- Blu oceano

Finiture disponibili solo in versione opaca
Finishes available only in matt version

Andromeda

Design: Paolo Ulian

Andromeda è una lampada che può assumere infinite configurazioni formali a seconda di come vengono "piegati" i vari elementi/diffusori esagonali.

Andromeda is a lamp that can produce an infinite number of formal configurations depending on how the various hexagonal diffusers/elements are "bent".





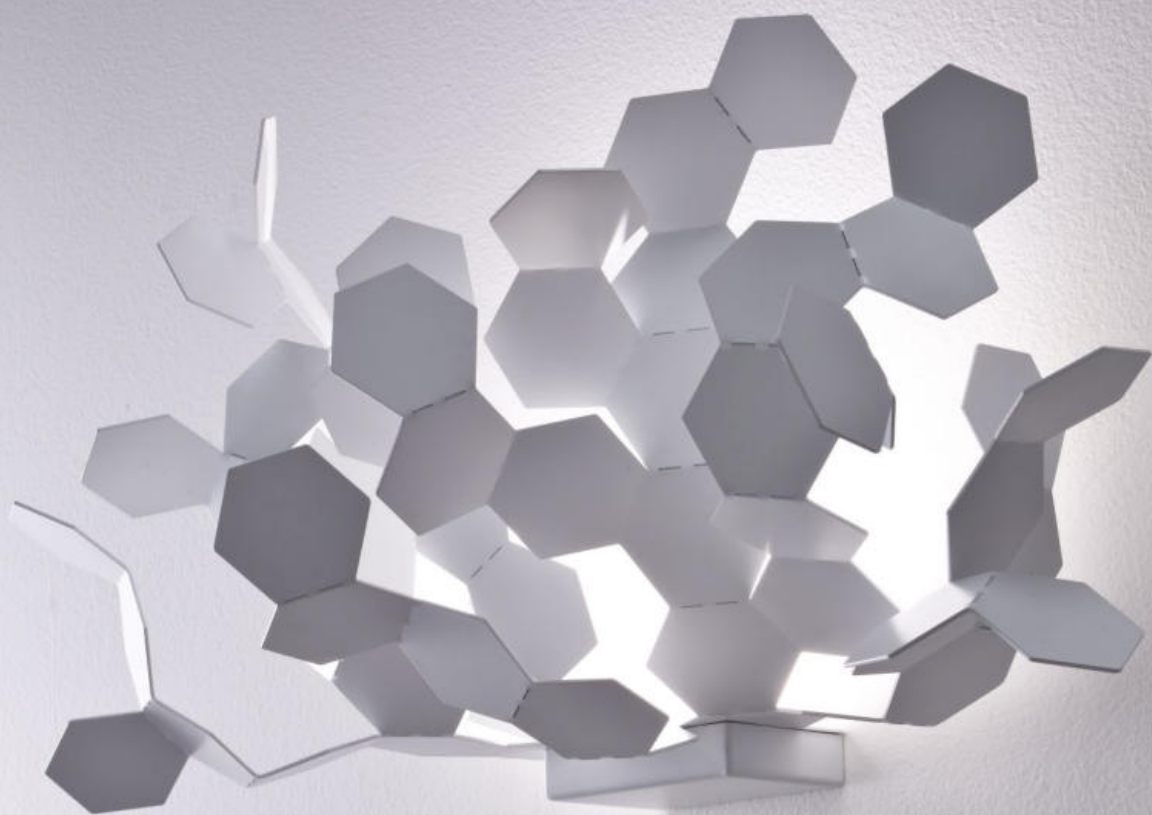

ANDROMEDA Sospensione Suspension **Sorgente luminosa Light source**

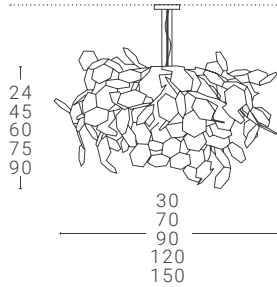

Dim.rosone: Ø 22 cm altezza 4 cm
Ceiling rose dim.: Ø 22 cm height 4 cm

Attacco E27 (lampadina esclusa) Max 105W
Lampholder E27 (bulb not included) Max 105W

Modello con sorgenti luminose multiple:
3 x Attacco E27 (lampadine escluse)
5 x Attacco E27 (lampadine escluse)
Multiple Light source model:
3 x Lampholder E27 (bulbs not included)
5 x Lampholder E27 (bulbs not included)

Versione da 30 cm 30cm version
Attacco E14 (lampadina esclusa) Max 42W
Lampholder E14 (bulb not included) Max 42W

ANDROMEDA Terra Floor

Sorgente luminosa Light source

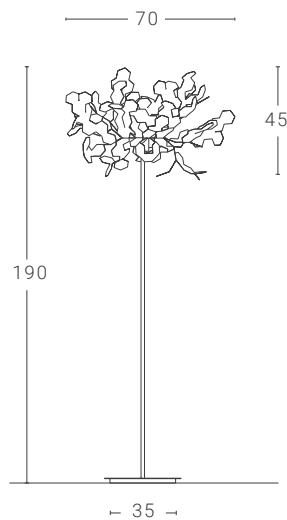

Attacco E27 (lampadina esclusa)
Max 70W
Lampholder E27 (bulb not included)
Max 70W

ANDROMEDA Parete Wall light

Sorgente luminosa Light source

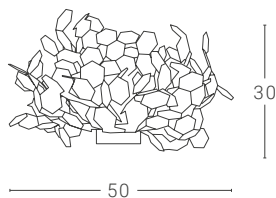





Attacco E27 (lampadina esclusa) Max 70W
Lampholder E27 (bulb not included) Max 70W

Sorgente luminosa LED LED Light source
LED 1 x 8W 230V 3000K 1000Lm Energy class A
Dimmable

Materiale Material

Alluminio, ferro
Aluminium, iron

Finiture Colours

-  RAL 9010 Finiture disponibili solo in versione opaca
Finishes available only in matt version
-  RAL 9005
-  Ottone satinato Satined brass
-  Ottone spazzolato Brushed brass

Arianna

Design: Paolo Ulian & Caterina di Michele

Una lampada come una bobina su cui arrotolare o srotolare il cavo elettrico per farlo arrivare in ogni parte della stanza, e anche più in là...

A lamp that is like a spool on to which to wind or unwind the electric cable, allowing it reach every corner of the room, and further still...

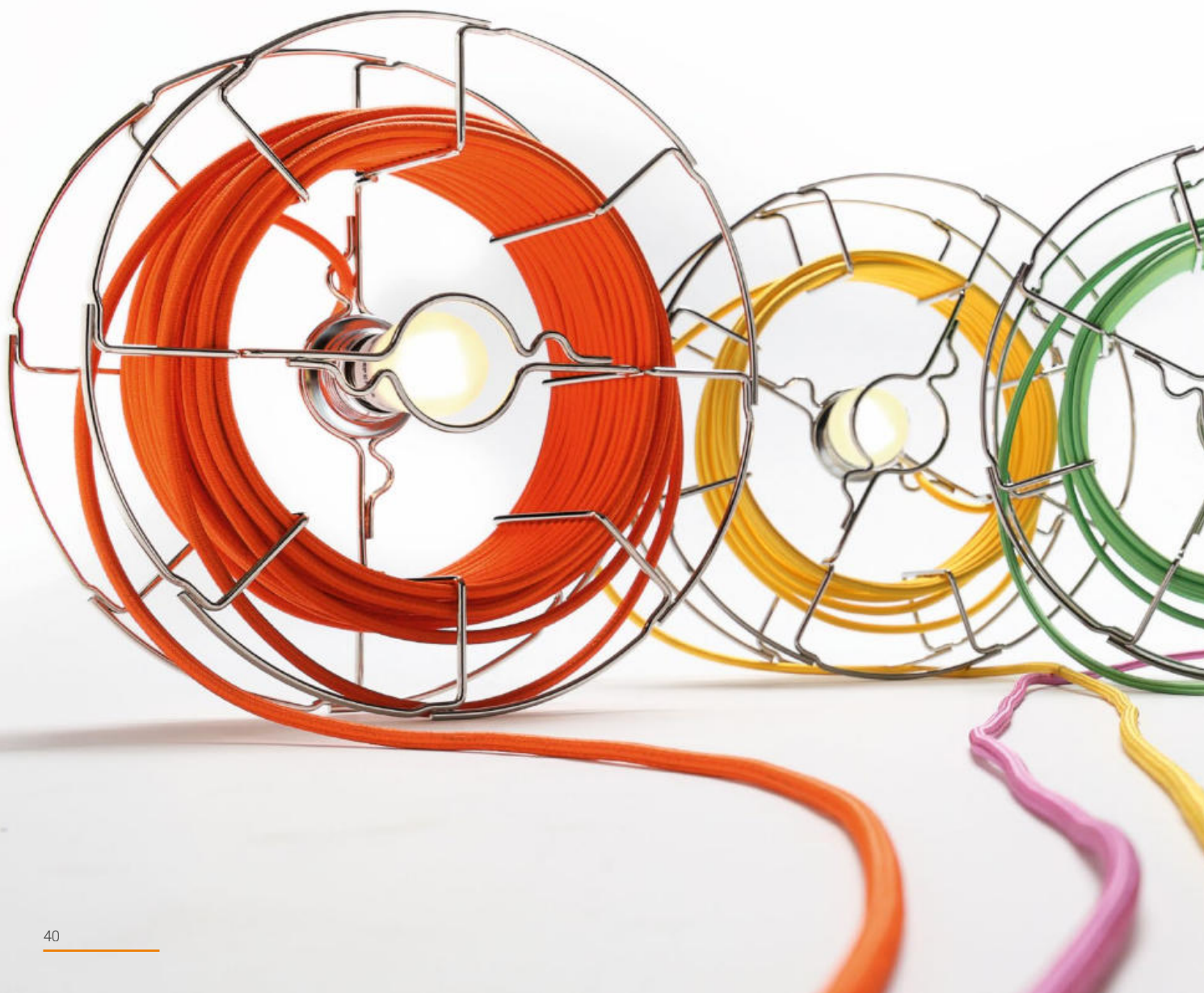



Arianna

Design: Paolo Ulian & Caterina di Michele

Tavolo Table

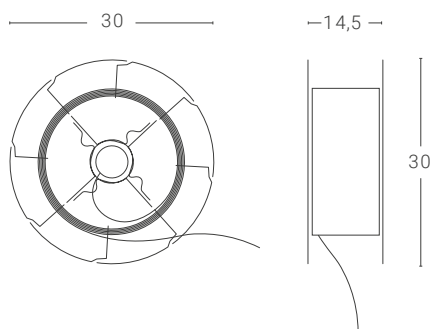

Sorgente luminosa Light source

Attacco E27 (lampadina esclusa)
Max 28W
Lampholder E27 (bulb not included)
Max 28W

Lunghezza cavo: 15 m
Cable length: 15 m

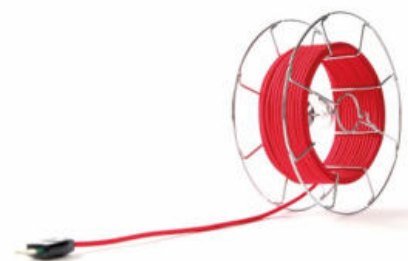

Parete Wall light

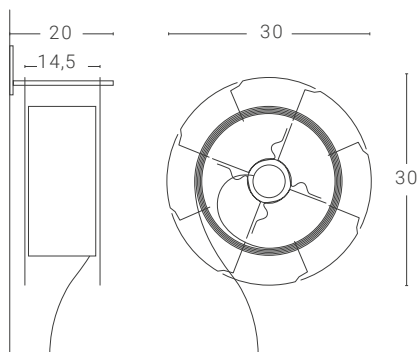

Sorgente luminosa Light source



Attacco E27 (lampadina esclusa)
Max 28W
Lampholder E27 (bulb not included)
Max 28W

Lunghezza cavo: 15 m
Cable length: 15 m

Materiale Material

Ferro; staffa in acciaio
per la versione parete.
Iron; steel hook for the
wall light version.

Finiture Colours

-  Cromo Chrome
-  RAL 9010
-  RAL 9005

Finiture disponibili solo in versione opaca
Finishes available only in matt version

Finiture cavo Cable colours

Colore a scelta (vedi tabella colori).
Colour on demand
(see cables colour chart).



Atom

Design: Franco Zavarise

Atom è la versione contemporanea della più tradizionale delle lampade a sospensione. Un filo, una lampadina, un paralume. La leggera curvatura del piatto metallico e le sue colorazioni di tendenza ne fanno un oggetto d'arredo iconico e polivalente, adatto a qualsiasi contesto: dalla casa al contract.

Atom is the contemporary version of the most traditional of the suspension lamps. A thread, a light bulb, a lampshade. The slight curvature of the metal plate and its trendy colors make it an iconic and multi-purpose piece of furniture suitable for any context: from home to contract.

Sospensione Suspension

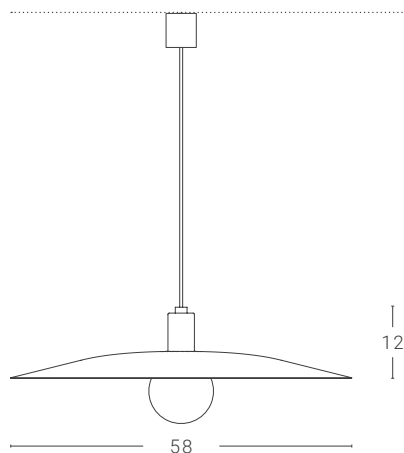

Dim. rosone: Ø 5,5 cm altezza 6 cm
Ceiling rose dim.: Ø 5,5 cm height 6 cm

Sorgente luminosa Light source

Attacco E27 (lampadina esclusa)
Max 70W
Lampholder E27 (bulb not included)
Max 70W

Materiale Material

Ferro o ottone
Iron or brass

Finiture esterne Outside colours

-  RAL 9010
-  RAL 9005
-  Ottone satinato
Satinated brass
-  Sahara
-  Verde giungla
Jungle green

Finiture disponibili solo in versione opaca
Finishes available only in matt version

Finiture interne Inside colours

Vedi tabella colori.
See colour chart.



Atrax

Design: BMB Progetti

Atrax nasce come lampada a sospensione decorativa e si sviluppa ulteriormente anche come applique e piantana. Elegante e dinamica trova la sua giusta collocazione nel mondo contract (ristoranti, hotel, hall etc) ma anche con dimensioni più ridotte, per la casa. La particolarità della sospensione è data dai numerosi profili metallici di varia lunghezza e curvatura che sostengono i corpi illuminanti sferici, creando nel suo insieme straordinari giochi di luce e una forte presenza scenica che arricchisce l'ambiente. Più minimale ma altrettanto dinamica è la versione a piantana a applique con un profilo metallico e una sfera come diffusione.

Atrax was born as a decorative pendant lamp and is further developed as a wall lamp and floor lamp. Elegant and dynamic, it finds its rightful place in the contract world (restaurants, hotels, halls, etc.) but also in smaller sizes, for the home. The particularity of the suspension is given by the numerous metal profiles of various lengths and curvatures that the spherical lighting bodies, creating as a whole extraordinary play of light and a strong scenic presence that enriches the environment. More minimalist but equally dynamic are both the floor and the wall version with a metal profile and a sphere as diffuser.



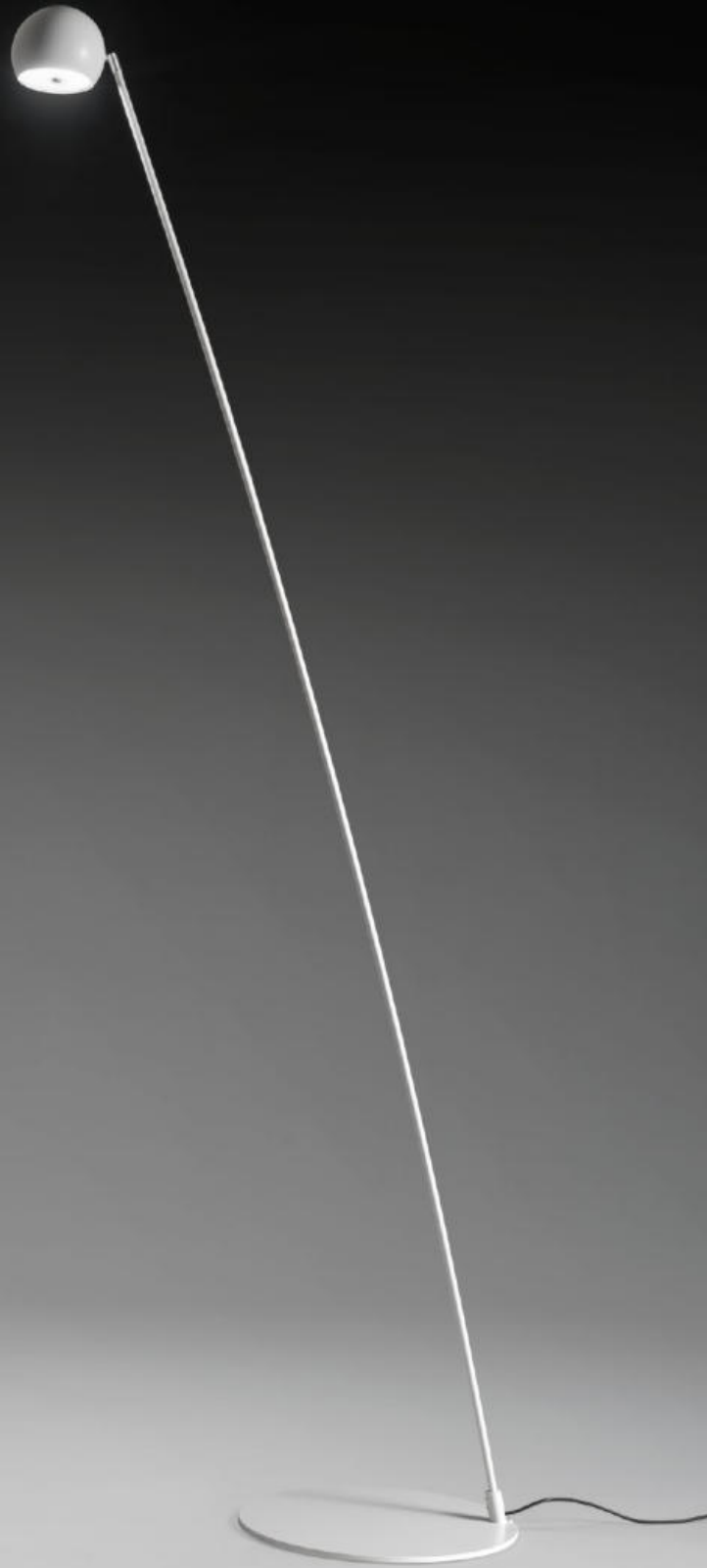



ATRAX Sospensione Suspension

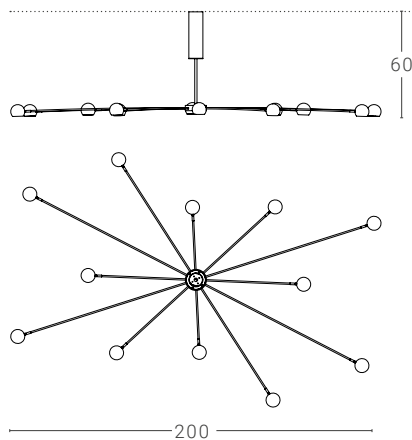

Sorgente luminosa Light source

LED · LED: 12 x 2,9W 530Lm 3000K
ON/OFF
Dimmable

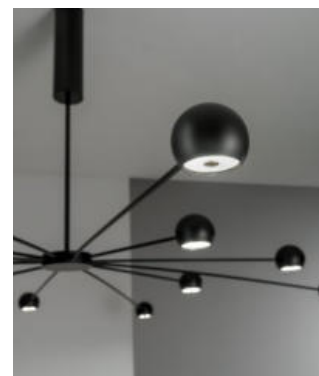

ATRAX Parete Wall light

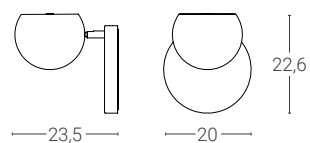

Sorgente luminosa Light source

LED · LED: 17W 2300Lm 3000K
ON/OFF
Dimmable

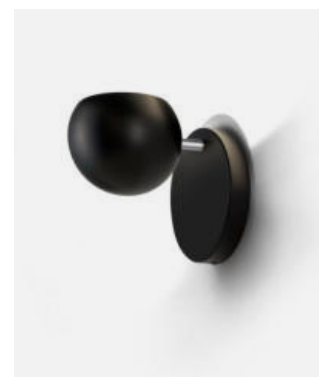

Materiale Material

Ferro / Iron

Finiture Colours

- | | | |
|------------|---------------------------|---|
| ○ RAL 9010 | ● Sahara | ● Matt silk grey RAL 7044 |
| ● RAL 9005 | ● Verde salvia Sage green | ● Giallo melone
Melon yellow
Ral 1028 |

Finiture disponibili solo in versione opaca
Finishes available only in matt version

Atrax

Design: BMB Progetti / Franco Zavarise

ATRAX Piantana Floor Light

Sorgente luminosa Light source

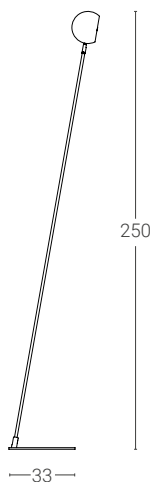

LED · LED: 17W 2300Lm 3000K
Dimmable



ATRAX Piantana Floor Light

Sorgente luminosa Light source

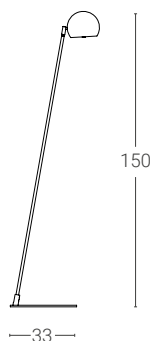

LED · LED: 17W 2300Lm 3000K
Dimmable

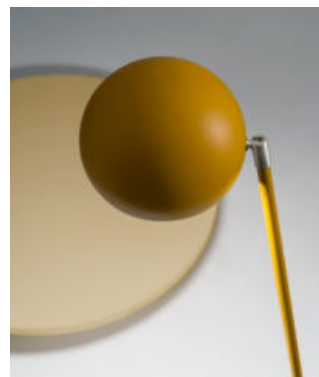

Materiale Material

Finiture Colours

Ferro / Iron

○ RAL 9010

● Sahara

● Matt silk grey RAL 7044

● RAL 9005

● Verde salvia Sage green

● Giallo melone
Melon yellow
Ral 1028

Finiture disponibili solo in versione opaca
Finishes available only in matt version



Berlino

Design: Franco Zavarise

"Tutto nasce da un'immagine che mi è rimasta impressa nella memoria. Una strada di Berlino illuminata da vecchi lampioni stradali."

"Everything springs from an image that is ingrained in the memory. A Berlin street lit by some old street lamps."

Sospensione Suspension

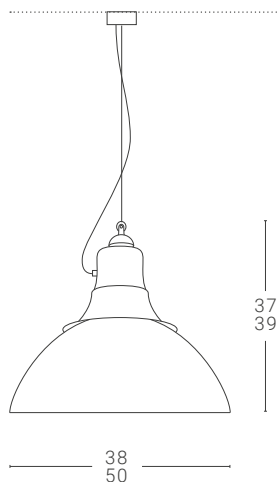

Dim. rosone: Ø 10 cm altezza 6 cm
Ceiling rose dim.: Ø 10 cm height 6 cm

Sorgente luminosa Light source

Attacco E27 (lampadina esclusa)
Max 105W
Lampholder E27 (bulb not included)
Max 105W

Materiale Material

Supporto in alluminio satinato o ferro verniciato.
Diffusore in vetro industriale.
Structure in satined aluminium or painted iron.
Diffuser in industrial glass.

Finiture Colours

- RAL 9010
- RAL 9005
- Grigio diaspro Jasper grey
- Alluminio Aluminium

Finiture disponibili solo in versione opaca
Finishes available only in matt version

Finiture cavo pvc Pvc cable colours

- Nero Black



Box

Design: Franco Zavarise

Box è una lampada da tavolo, a parete o a soffitto, che rende omaggio alla tradizionale lampadina. E lo fa racchiudendola in una cornice metallica che ne mette in risalto le forme. La lampada Box può essere personalizzata con tutte le nuovissime lampadine a LED in stile vintage.

Box is both a table wall and ceiling lamp, which pays homage to the traditional light bulb. And it does so by enclosing it in a metal frame that highlights its forms. The Box lamp can be customised with all the new vintage-style LED bulbs.





BOX Libreria Bookcase

Sorgente luminosa Light source

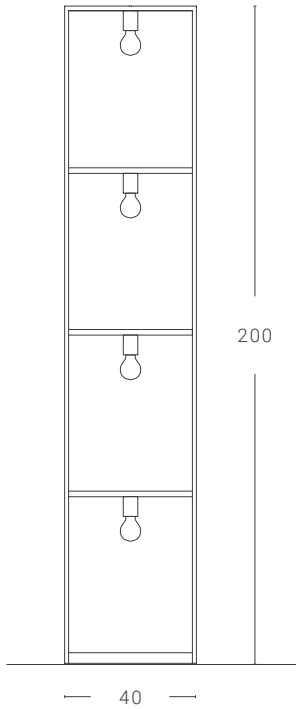

4 x Attacco E27 (lampadina esclusa)
Max 70W
4 x Lampholder E27 (bulb not included)
Max 70W

BOX Tavolo Table

Sorgente luminosa Light source

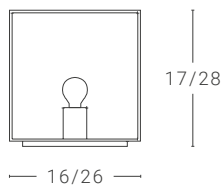

Attacco E14 (lampadina esclusa)
Max 42W
Lampholder E14 (bulb not included)
Max 42W

Materiale Material

Ferro
Iron

Finiture Colours

- | | |
|--|--|
|  RAL 9010 |  Blu oceano Ocean blue |
|  RAL 9005 |  Verde giungla Jungle green |
|  Sahara |  Verde artico Arctic green |

Finiture disponibili solo in versione opaca
Finishes available only in matt version





BOX Parete Wall light

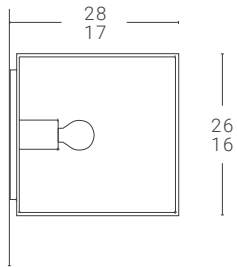

Sorgente luminosa Light source

H = 26cm: attacco E27 (lampadina esclusa)
Max 70W
H = 26cm: lampholder E27 (bulb not included)
Max 70W

H = 16cm: attacco E14 (lampadina esclusa)
Max 42W
H = 16cm: lampholder E14 (bulb not included)
Max 42W

BOX Plafoniera Ceiling light

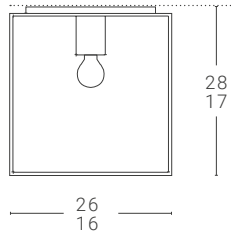

Sorgente luminosa Light source

H = 28cm: attacco E27 (lampadina esclusa)
Max 70W
H = 28cm: lampholder E27 (bulb not included)
Max 70W

H = 17cm: attacco E14 (lampadina esclusa)
Max 42W
H = 17cm: lampholder E14 (bulb not included)
Max 42W

BOX Terra Floor

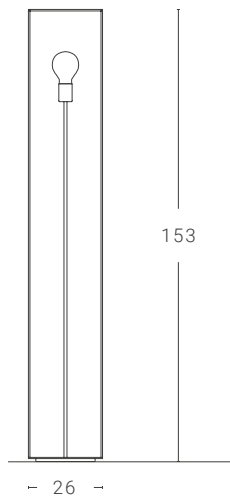







Sorgente luminosa Light source

Attacco E27 (lampadina esclusa)
Max 70W
Lampholder E27 (bulb not included)
Max 70W

Materiale Material

Ferro
Iron

Finiture Colours

- | | |
|--|--|
|  RAL 9010 |  Blu oceano Ocean blue |
|  RAL 9005 |  Verde artico Arctic green |
|  Sahara |  Verde giungla Jungle green |

Finiture disponibili solo in versione opaca
Finishes available only in matt version

Bull

Design: Franco Zavarise

Uno dei pezzi storici della collezione Zava, reintrodotta in una nuova versione LED più elegante e dal design più contemporaneo. Una lampada che ben si adatta a più composizioni; assemblabile in linea, a grappolo o con il sistema di sospensione Ragi e ZERO2.

One of the historic pieces from the Zava collection, reintroduced in a new LED version with a sleeker, more contemporary design. A lamp that is well adapted to multiple compositions; in line formation, cluster formation or with a Ragi and ZERO2 suspension systems.

Sospensione Suspension

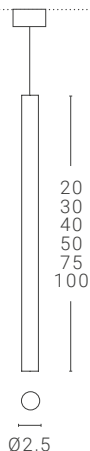

Dim. rosone: Ø 6 cm altezza 12 cm
Ceiling rose dim.: Ø 6 cm height 12 cm

Le dimensioni del rosone nella variante DALI/PUSH possono essere diverse
The dimensions of the ceiling rose in DALI / PUSH variant can be different

Sorgente luminosa Light source

Bull Bull:

LED 1 x 1,5W 230V 3000K 137Lm
CRI>80 Energy Class A
Angoli di emissione disponibili: 25°, 40°, 60°
Available emission angles: 25°, 40°, 60°
Driver ON/OFF incluso / ON/OFF driver included

Bull power Bull power:

LED 1 x 4W 230V 3000K 380Lm
CRI>90 Energy Class A
Sistema ottico in vetro · Glass optical system
Angoli di emissione disponibili: 20°, 40°, 60°
Available emission angles: 20°, 40°, 60°
Driver ON/OFF incluso / Disponibile driver dimmerabile DALI/PUSH su richiesta
ON/OFF driver included / DALI/PUSH dimmable driver available on request

Materiale Material

Ferro o ottone (solo per versione power)
Iron or brass (only for power version)

Finiture Colours

○ RAL 9010

● Rosa quarzo Quartz Pink

● Blu oceano Ocean blue

● RAL 9005

● Verde giungla Jungle green

● Ottone * Brass *

● Sahara

● Verde artico Arctic green

Finiture disponibili solo in versione opaca
Finishes available only in matt version

* Disponibile solo per versione power
* Available only for power version



Cantiere

Design: Alberto Ghirardello

Cantiere, come il nome suggerisce, è una lampada che si rifà al mondo dell'illuminazione tecnica per siti di costruzione ma rivisitata in chiave contemporanea ed essenziale per un ambiente domestico. L'ampio corpo illuminante circolare garantisce una generosa illuminazione, mentre la griglia dona alla lampada carattere e un aspetto forte e deciso.

Cantiere, like the name suggests, is a lamp which reminds us of technical lighting for construction sites but is revisited for home environments in a contemporary and essential way. The large circular luminaire provides generous illumination and the grid gives it character and a strong appearance.





CANTIERE Terra Floor

Sorgente luminosa Light source

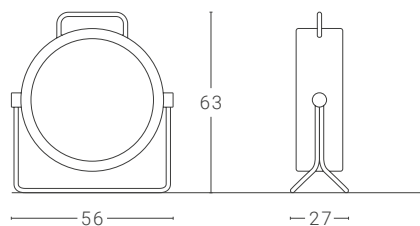

LED 1 x 32W 230V 3000K 3950Lm/4310Lm Energy class A
Driver ON/OFF incluso / Disponibile driver dimmerabile DALI/PUSH su richiesta
ON/OFF driver included / DALI/PUSH dimmable driver available on request

Versione senza griglia / Version without grid

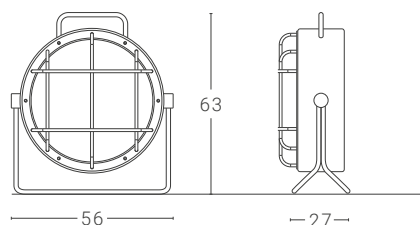

Versione con griglia / Version with grid

CANTIERE Plafoniera Ceiling light

Sorgente luminosa Light source

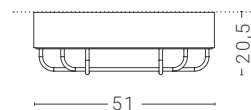

LED 1 x 32W 230V 3000K 3950Lm/4310Lm Energy class A
Driver ON/OFF incluso / Disponibile driver dimmerabile DALI/PUSH su richiesta
ON/OFF driver included / DALI/PUSH dimmable driver available on request

CANTIERE Parete Wall light

Sorgente luminosa Light source

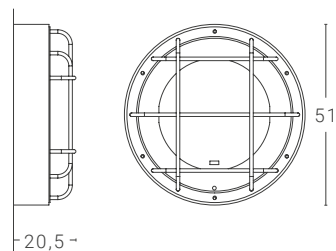

LED 1 x 32W 230V 3000K 3950Lm/4310Lm Energy class A
Driver ON/OFF incluso / Disponibile driver dimmerabile DALI/PUSH su richiesta
ON/OFF driver included / DALI/PUSH dimmable driver available on request

Materiale Material

Ferro, metacrilato
Iron, methacrylate

Finiture Colours

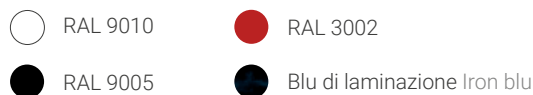

Finiture disponibili solo in versione opaca
Finishes available only in matt version





CANTIERE OUTDOOR Terra Floor

Sorgente luminosa Light source

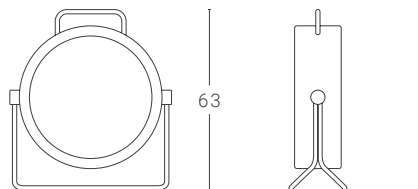

Versione senza griglia / Version without grid

LED 1 x 32W 230V 3000K 3950Lm
Energy Class A
Driver ON/OFF incluso / ON/OFF driver included
Disponibile driver dimmerabile DALI/PUSH su richiesta
DALI/PUSH dimmable driver available on request

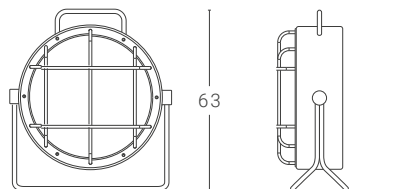

Versione con griglia / Version with grid

CANTIERE OUTDOOR Plafoniera Ceiling light

Sorgente luminosa Light source

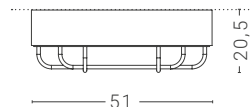

LED 1 x 32W 230V 3000K 3950Lm
Energy Class A
Driver ON/OFF incluso / ON/OFF driver included
Disponibile driver dimmerabile DALI/PUSH su richiesta
DALI/PUSH dimmable driver available on request

CANTIERE OUTDOOR Parete Wall light

Sorgente luminosa Light source

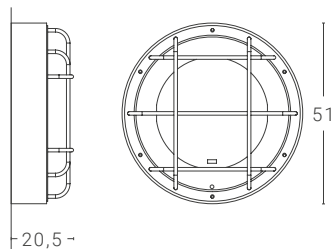

LED 1 x 32W 230V 3000K 3950Lm
Energy Class A
Driver ON/OFF incluso / ON/OFF driver included
Disponibile driver dimmerabile DALI/PUSH su richiesta
DALI/PUSH dimmable driver available on request

Materiale Material

Ferro, metacrilato
Iron, methacrylate

Finiture Colours

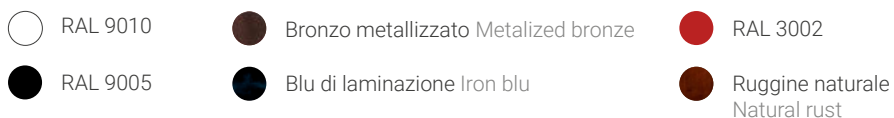

Finiture disponibili solo in versione opaca
Finishes available only in matt version



Meta
Design Franco Zavarise

Pag. 132

Etrè
Design Alberto Caramello

Pag. 85

Box
Design Franco Zavarise

Pag. 56

Amedeo
Design Amedeo Mander

Pag. 30



Amedeo
Design Franco Zavarise

Pag. 32



Cosima

Design: Cédric Davies

Cosima è una lama di luce che disegna gli spazi con le sue linee minimali. Un tubo luminoso in plexiglass opalino con i due poli in ottone o in metallo verniciato. Una lampada estremamente flessibile, che stimola la creatività del progettista: può essere utilizzata singolarmente ma consente anche di creare composizioni personalizzate sulle pareti o di immaginare scenografiche soluzioni sospese, anche in ambienti di grandi dimensioni.

A blade of light that draws spaces with its minimal lines. A luminous tube in opal plexiglass (available in different lengths) with the metal frame in brass or in painted metal. Cosima is an extremely flexible lamp that stimulates the designer's creativity. It can be used individually but also allows you to create custom compositions on the walls or to imagine spectacular suspended solutions even in large environments.

Sospensione Suspension

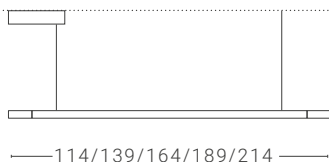

Sorgente luminosa Light source

114 cm: LED 1 x 18W 24V dc 3000K CRI>94 1700Lm Energy class A
139 cm: LED 1 x 23W 24V dc 3000K CRI>94 2100Lm Energy class A
164 cm: LED 1 x 28W 24V dc 3000K CRI>94 2600Lm Energy class A
189 cm: LED 1 x 33W 24V dc 3000K CRI>94 3050Lm Energy class A
214 cm: LED 1 x 37W 24V dc 3000K CRI>94 3500Lm Energy class A

Dim. rosone:

7,5 x 23,5 altezza 3,8 cm

Ceiling rose dim.:

7,5 x 23,5 height 3,8 cm

Alimentatore dimmerabile DALI/PUSH incluso nel rosone

DALI/PUSH dimmable power supply included in the ceiling rose

Parete o plafoniera

Wall or ceiling light

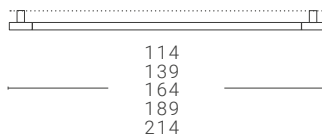

Sorgente luminosa Light source

114 cm: LED 1 x 18W 24V dc 3000K CRI>94 1700Lm Energy class A
139 cm: LED 1 x 23W 24V dc 3000K CRI>94 2100Lm Energy class A
164 cm: LED 1 x 28W 24V dc 3000K CRI>94 2600Lm Energy class A
189 cm: LED 1 x 33W 24V dc 3000K CRI>94 3050Lm Energy class A
214 cm: LED 1 x 37W 24V dc 3000K CRI>94 3500Lm Energy class A

Alimentatore remoto fornito solo su richiesta /

Disponibile alimentatore dimmerabile DALI/PUSH su richiesta

Dim. rosone: 26 cm altezza 5 cm

Ceiling rose dim.: 26 cm height 5 cm

Remote power supply available only on request /

DALI/PUSH dimmable power supply available on request

Materiale Material

Metacrilato, ottone, alluminio
Methacrylate, ottone, aluminium

Finiture Colours

○ RAL 9010

● Ottone Brass

● RAL 9005

Finiture disponibili solo in versione opaca
Finishes available only in matt version



Crack

Design: Raul Girotto



Realizzata in metallo verniciato. La luce della lampadina è attenuata da un rivestimento in opale.

Created in painted metal. The bulb's light is softened by a opale covering.

Parete Wall light

Sorgente luminosa Light source

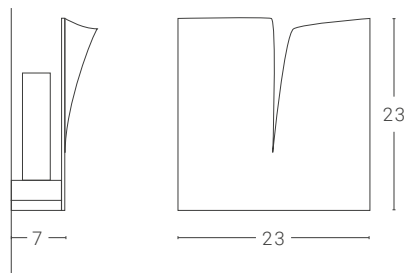

Attacco E14 (lampadina esclusa)
Max 42W
Lampholder E14 (bulb not included)
Max 42W

Materiale Material

Ferro
Iron

Finiture Colours

- RAL 9010
- RAL 9005
- Ruggine naturale Natural rust
- Blu di laminazione Iron blu

Finiture disponibili solo in versione opaca
Finishes available only in matt version



Dot to dot

Design: C12+

Ispirata al gioco in cui si devono collegare i puntini per creare delle figure, Dot to dot è una lampada da parete componibile, che permette di ottenere infinite soluzioni formali. I bracci, che incorporano la strip LED, sono disponibili in sei diverse lunghezze, da usare singolarmente o da associare tra loro grazie agli snodi circolari. Definendo zone di luce e ombra, il fascio di luce radente permette di creare disegni luminosi personalizzati.

The idea comes from the game in which you connect dots to see the image. Dot to dot is a combinable wall lamp that allows you to create infinite formal solutions. The arms, that incorporate a strip of LED, are available in six different lengths and can be used individually or combined thanks to their circular junction. Outlining areas of shadows and lights, the light beam allows you to create your own light designs.

Parete e plafoniera

Wall and ceiling light

30/60/90/120/149/199*



Dimensioni:

Rosone con alimentatore:

Ø 26 cm - h. 4,5 cm.

Connettori: Ø 5 cm h. 4,5 cm.

Angolo da 45°, da 90° e 135°

Dimensions:

Rose with power supply unit:

Ø 26 cm - h. 4,5 cm.

Terminals: Ø 5 cm h. 4,5 cm.

Angle 45°, 90° and 135°

* Dimensione disponibile solo per installazione verticale

* Size available for vertical installation only

Le dimensioni del rosone nella variante DALI/PUSH possono essere diverse.

The dimensions of the ceiling rose/rosette in DALI/PUSH variant can be different.

Sorgente luminosa Light source

Versione in ferro verniciato / Painted iron version:

Sorgente luminosa LED · LED Light source: CRI>94, 240 LED/m

30 cm: LED 1 x 6W 24V dc 3000K 450Lm Energy class A

60 cm: LED 1 x 12W 24V dc 3000K 910Lm Energy class A

90 cm: LED 1 x 18W 24V dc 3000K 1370Lm Energy class A

120 cm: LED 1 x 23W 24V dc 3000K 1820Lm Energy class A

149 cm: LED 1 x 29W 24V dc 3000K 2280Lm Energy class A

199 cm: LED 1 x 39W 24V dc 3000K 3040Lm Energy class A

Versione ferro e alluminio o ottone / Iron and aluminium or brass version:

Sorgente luminosa LED · LED Light source: IP67, CRI>80, 210 LED/m

30 cm: LED 1 x 5W 24V dc 3000K 370Lm Energy class A

60 cm: LED 1 x 9W 24V dc 3000K 740Lm Energy class A

90 cm: LED 1 x 13W 24V dc 3000K 1100Lm Energy class A

120 cm: LED 1 x 16,5W 24V dc 3000K 1450Lm Energy class A

149 cm: LED 1 x 21W 24V dc 3000K 1800Lm Energy class A

199 cm: LED 1 x 26W 24V dc 3000K 2400Lm Energy class A

Lunghezza massima del sistema modulare su unico alimentatore 6 m

Maximum length of the modular system on a single power supply unit 6 m

Alimentatore ON/OFF incluso /

Disponibile alimentatore dimmerabile DALI/PUSH su richiesta

ON/OFF driver included / DALI/PUSH dimmable driver available on request

Disponibile anche versione outdoor

Outdoor version available

Materiale Material

Interno: ferro e alluminio o ottone

Indoor: iron and aluminium or brass

Esterno: ferro e alluminio o ottone

Outdoor: iron and aluminium or brass

Finiture Colours



RAL 9010

Finiture disponibili solo in versione opaca

Finishes available only in matt version



RAL 9005



Ottone Brass



Verde artico Arctic green





Driyos

Design: Delineodesign

Spoglia di vezzi decorativi ed essenziale nelle finiture, Driyos ha un aspetto rigoroso caratterizzato da linee precise e geometriche. Esprime la sua forte personalità e sorprende anche grazie al singolare sistema di sospensione, che permette di avvolgere parte del cavo in modo da poter regolare l'altezza della lampada semplicemente, a seconda delle esigenze.

Stripped of decorative charms and essential in finishes, Driyos has a rigorous look, characterized by clean and geometric lines. Driyos expresses its strong personality and can surprise also thanks to the unusual suspension system, which allows you to wrap part of the cable in order to adjust the height of the lamp in a simple way.

Sospensione Suspension Ø21

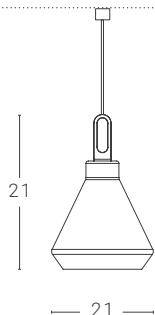

Dim. rosone: Ø 5,5 altezza 6 cm
Ceiling rose dim.: Ø 5,5 cm height 6 cm

Sorgente luminosa Light source

Attacco E27 (lampadina esclusa) Max 70W
Lampholder E27 (bulb not included) Max 70W

Attacco GU10 Max 15W
Lampholder GU10 Max 15W
Lampadina LED a tensione di rete
LED mains voltage bulb
1 x 13W 230V 2700K/4000K 880Lm/950Lm Energy Class A
Dimmerabile a taglio di fase solo con regolatori selezionati non forniti da ZAVA. /
Elenco modelli a richiesta
Phase-cut dimmable only with selected controllers not supplied by ZAVA.
List of models on request

Sospensione Suspension Ø30

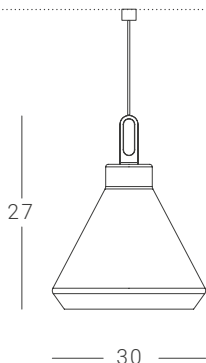

Dim. rosone: Ø 8,5 altezza 8 cm
Ceiling rose dim.: Ø 8,5 cm height 8 cm

Sorgente luminosa Light source

Attacco E27 (lampadina esclusa) Max 70W
Lampholder E27 (bulb not included) Max 70W

Attacco GU10 Max 15W
Lampholder GU10 Max 15W
Lampadina LED a tensione di rete
LED mains voltage bulb
1 x 13W 230V 2700K/4000K 880Lm/950Lm Energy Class A
Dimmerabile a taglio di fase solo con regolatori selezionati non forniti da ZAVA. /
Elenco modelli a richiesta
Phase-cut dimmable only with selected controllers not supplied by ZAVA.
List of models on request

Disponibile anche versione outdoor
Outdoor version available

DRIYOS Sospensione Suspension Ø37 Sorgente luminosa Light source

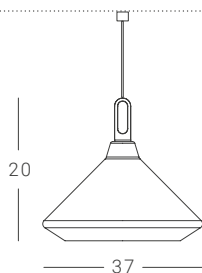

Dim. rosone: Ø 8,5 altezza 8 cm
Ceiling rose dim.: Ø 8,5 cm height 8 cm

Attacco E27 (lampadina esclusa) Max 70W
Lampholder E27 (bulb not included) Max 70W

Attacco GU10 Max 15W
Lampholder GU10 Max 15W
Lampadina LED a tensione di rete
LED mains voltage bulb
1 x 13W 230V 2700K/4000K 880Lm/950Lm Energy Class A
Dimmerabile a taglio di fase solo con regolatori selezionati non forniti da ZAVA. /
Elenco modelli a richiesta
Phase-cut dimmable only with selected controllers not supplied by ZAVA.
List of models on request

DRIYOS Sospensione Suspension Ø50 Sorgente luminosa Light source

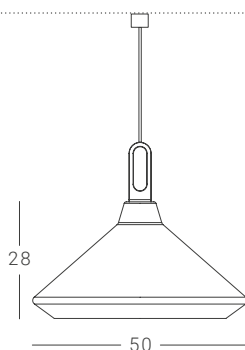

Dim. rosone: Ø 8,5 altezza 8 cm
Ceiling rose dim.: Ø 8,5 cm height 8 cm

Attacco E27 (lampadina esclusa) Max 70W
Lampholder E27 (bulb not included) Max 70W

Attacco GU10 Max 15W
Lampholder GU10 Max 15W
Lampadina LED a tensione di rete
LED mains voltage bulb
1 x 13W 230V 2700K/4000K 880Lm/950Lm Energy Class A
Dimmerabile a taglio di fase solo con regolatori selezionati non forniti da ZAVA. /
Elenco modelli a richiesta
Phase-cut dimmable only with selected controllers not supplied by ZAVA.
List of models on request

Disponibile anche versione outdoor
Outdoor version available

Finiture esterne Outside colours

- RAL 9010
- RAL 9005
- RAL 3002
- RAL 6034
- RAL 1019
- Blu di laminazione
Iron blu

Disponibile anche verniciata o ferro blu
di laminazione con interno foglia
oro / argento / rame.
Available also painted or blue iron with
golden / silver / copper leaf inside

Finiture disponibili solo in versione opaca
Finishes available only in matt version

Materiale Material

Ferro / Iron

Finiture interna Inside colours

Vedi tabella colori.
See colour chart.

Finitura cavo Cable colours

Colore a scelta
(vedi tabella colori).
Colour on demand
(see cables colour chart).



Driyos Naked

Design: Delineodesign

Semplici segni che racchiudono funzionalità e prendono vita con colori di tendenza: Driyos Naked, versione minimal della lampada Driyos, si adatta a qualsiasi ambiente e necessità.

Simple signs which encapsulate functionality and come to life with trendy colors: Driyos Naked, minimal version of Driyos lamp, adapts to any environment and needs.



DRIYOS NAKED Sospensione Suspension Sorgente luminosa Light source

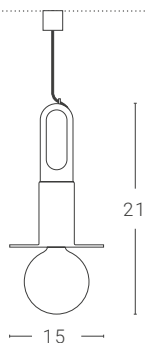

Attacco E27 (lampadina esclusa)
Max 70W
Lamp holder E27 (bulb not included)
Max 70W

Dim. rosone: Ø 4,5 cm altezza 7 cm
Ceiling rose dim.: Ø 4,5 cm height 7 cm

Materiale Material

Ferro / Iron

Finiture Colours

○ RAL 9010

● RAL 9005

● RAL 3002

● RAL 6034

● RAL 1019

Finiture disponibili solo in versione opaca
Finishes available only in matt version

Etrè

Design: Alberto Caramello

Volumi che diventano impalpabili intersecandosi con il vuoto. Etrè è una collezione di lampade che si inserisce in punta di piedi in molteplici ambienti. Tre sottili elementi si tendono verso l'alto sottolineando la leggerezza di una struttura in metallo, unica nota delicata di colore.

Volumes that become impalpable, intersecting with the empty space. Etrè is a collection of lamps that is placed on tiptoe in multiple environments. Three thin elements stretch upwards underlining the lightness of a metal structure, which is the only colour touch on it.







Etrè

Design: Alberto Caramello

Terra Floor

Sorgente luminosa Light source

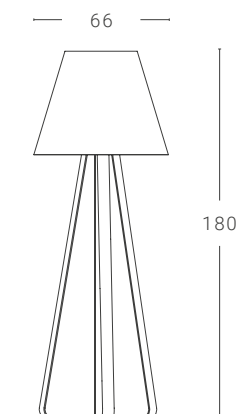

Attacco E27 (lampadina esclusa) Max 70W
Lampholder E27 (bulb not included) Max 70W

Parete Wall light

Sorgente luminosa Light source

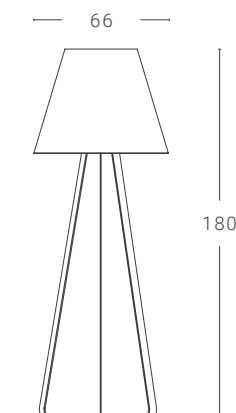

Attacco E27 (lampadina esclusa) Max 70W
Lampholder E27 (bulb not included) Max 70W

Materiale Material

Ferro, metacrilato
Iron, methacrylate

Finiture Colours

○ RAL 9010

Finiture disponibili solo in versione opaca
Finishes available only in matt version

● RAL 9005

● Sahara



Fenex

Design: Franco Zavarise

Si chiama Fenex questa lampada da tavolo ricaricabile dalla linea semplice ma evocativa. La sua forma, che ricorda un calice rovesciato, è stata studiata appositamente per creare la massima diffusione della luce intorno a sé.

Fenex può essere personalizzata con un dettaglio cromato o colorato, così da potersi coordinare a qualsiasi ambiente.

Fenex is a portable - rechargeable table lamp with a simple but evocative line. Its shape reminiscent of an inverted glass has been specifically designed to create the maximum diffusion of light around itself.

Fenex can be customized with a chrome or colored detail so that it can coordinate with any environment.

Ricaricabile Rechargeable

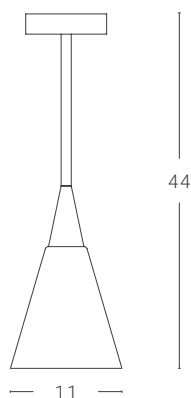

Sorgente luminosa Light source

LED 1 x 1,8W 220Lm 3000K
Tre livelli di luce selezionabili /
Three selectable light levels
Durata delle batterie / Battery life:
8h @100%, 16h @50%, 24h @25%

Batterie e cavo USB-C incluso / Le batterie
hanno una durata di 5 giorni a lampada
spenta, dopodichè è necessaria la ricarica
dell'apparecchio.

Battery and USB-C cable included
Lamp off battery life: 5 days, after which it
is necessary to recharge the device.



Materiale Material

Ferro, ottone
Iron, brass

Finiture struttura Structure colours

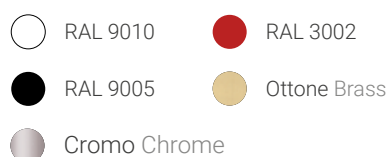

Finitura disponibili solo in versione opaca
Finish available only in matt version

Finiture disco Disk colours

Colore personalizzabile su richiesta
(vedi lista colori a fine catalogo)
Colour customizable on demand (see
colours list of at the end of catalogue)



Box
Design Franco Zavarise

Pag. 56

Amedeo
Design Franco Zavarise

Pag. 32



Box
Design Franco Zavarise

Pag. 56

Tank
Design Delineodesign

Pag. 246

Amedeo
Design Franco Zavarise

Pag. 32

Jeena
Design Franco Zavarise

Pag. 104



Flamenco

Design: Meneghella Paoletti Associati

Flamenco interpreta il concetto di “destrutturazione” dove ogni elemento della piantana appare, a un primo sguardo, distinto e svincolato dagli altri, come se fosse un corpo a sè. Come per il volatile di cui evoca il nome (il fenicottero appunto, flamenco in spagnolo), i singoli elementi trovano equilibrio quando vengono accostati tra loro.

L'effetto di insieme è armonioso pur nella “disarmonia” delle parti. La base a parallelepipedo, stretta e alta, è il cuore pulsante del sistema: cambia finitura e “pelle” a seconda dell'ambiente che lo deve accogliere. Proposta nelle varianti in marmo, legno, ferro o cemento, offre una solida base d'appoggio allo stelo che si innesta su di essa mantenendo un design esile e affusolato.

Flamenco interprets the concept of “deconstruction” where each element of the floor lamp appears, at first glance, distinct and unencumbered by the others, as if it were a body in itself. As for the bird whose name it evokes (the flamingo in fact, flamenco in Spanish), the individual elements find equilibrium when they are put together.

The overall effect is harmonious even in the “disharmony” of the parts. The narrow and high parallelepiped base is the beating heart of the system: it changes finish according to the environment that must accommodate it.

Proposed in marble, wood, iron or concrete, it offers a solid base to support the stem that is grafted onto it while maintaining a slender and tapered design.

Terra Floor

Sorgente luminosa Light source

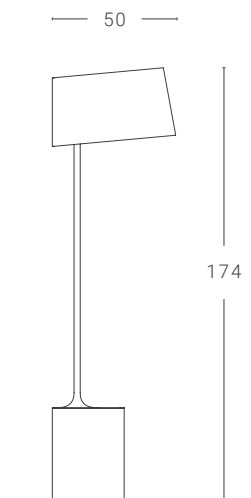

Attacco E27 (lampadina esclusa)
Max 70W
Lampholder E27 (bulb not included)
Max 70W

Materiale Material

Ferro + ecomalta / legno / marmo /
ottone (vedi pagina seguente)
Iron + ecomalta / wood / marble /
brass (see next page)



Flamenco

Design: Meneghello Paoletti Associati

Finitura della base Base finish

Versione A: Ecomalta®
Version A: Ecomalta®

Finiture esterne Outside colours

○ RAL 9010
● RAL 9005

Finiture interne paralume Lampshade inside colours

Vedi tabella colori.
See colour chart.

Versione B: legno
Version B: wood

○ RAL 9010
● RAL 9005
● Effetto corten Corten effect

Vedi tabella colori.
See colour chart.

Versione C: marmo
(vedi lista colori a fine catalogo)
Version C: marble
(see colour list at the end of the catalog)

○ RAL 9010
● RAL 9005
● Sahara
● Verde salvia Sage green

Vedi tabella colori.
See colour chart.

Versione D: ottone
Version D: brass

○ RAL 9010
● RAL 9005

Vedi tabella colori.
See colour chart.

Versione E: verniciata (vedi tabella colori), foglia oro/argento/rame o blu di laminazione
Version E: Painted (see colour chart), gold/silver/copper leaf or iron blue

○ RAL 9010
● RAL 9005

Vedi tabella colori.
See colour chart.

Finiture disponibili solo in versione opaca
Finishes available only in matt version

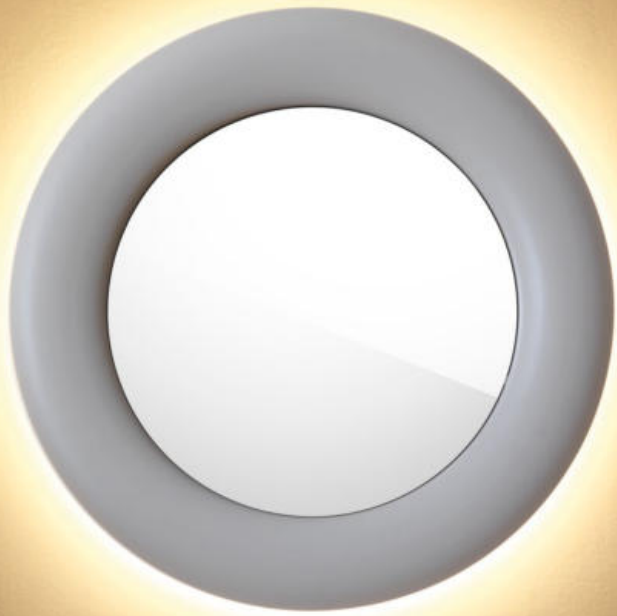

Flow

Design: Valerio Cometti+V12 design

In un mondo sempre più rumoroso, la luce è una benvenuta forma di energia silenziosa. Lo stesso garbo e la stessa compostezza vengono rappresentati da Flow, un'applicazione che vuole raggiungere un nuovo dialogo con l'architettura che la ospita. Le forme pulite e morbide di Flow valorizzano il ruolo della luce: Flow diventa attrazione irresistibile per l'occhio attento che ne sappia cogliere il messaggio elegante e di grande rispetto per la luce che le dà vita. La vista frontale di Flow presenta il rigore del cerchio, ma la morbidezza della superficie di rivoluzione che ne costituisce il corpo le offre una misurata sensualità. Non da ultimo, il design di Flow è valorizzato dalla grande conoscenza e capacità manifatturiera con il metallo che Zava ha maturato negli anni.

In an increasingly noisy world, light is a welcome form of silent energy. The same grace and composure are represented by Flow, a wall lamp that aims to reach a new dialogue with the architecture that hosts it. The clean and soft shapes of Flow enhance the role of light: Flow becomes an irresistible attraction for the watchful eye that knows how to grasp the elegant message of great respect for the light that gives it life. The front view of Flow presents the rigor of the circle, but the softness of the surface that constitutes the body offers a measured sensuality. Last but not least, Flow's design is enhanced by the great knowledge and manufacturing ability with the metal that Zava has matured over the years.

Parete Wall light

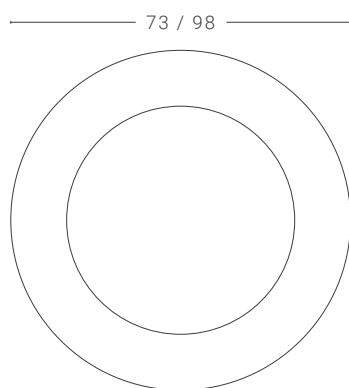

Sorgente luminosa Light source

LED 32W 230V 3000K 3600Lm
CRI>94 Energy class A

LED 52W 230V 3000K 4800Lm
CRI>94 Energy class A

Alimentatore ON/OFF incluso / Disponibile
alimentatore dimmerabile DALI/PUSH su richiesta
ON/OFF power supply included / DALI/PUSH
dimmable power supply available on request

Materiale Material

Ferro, metacrilato, acciaio.
Iron, methacrylate, steel.

Finiture esterne Outside colours

○ RAL 9010

● RAL 9005

Finiture disponibili solo in versione opaca
Finishes available only in matt version

Finiture interne Inside colours

Acciaio lucidato a specchio o verniciata
(vedi cartella colori).
Mirror polished steel or painted
(see colour chart).



Hook

Design: Franco Zavarise

Hook è un supporto a parete personalizzabile che trasforma in applique qualsiasi paralume della collezione ZAVA (comprese le sospensioni), purché funzionino a tensione di rete. Hook si caratterizza per il suo braccio rotante di quasi 180° e variabile in altezza e in lunghezza, a seconda delle necessità. Hook è un sistema perfetto per illuminare i locali contract, ma anche per gli ambienti domestici: in un corridoio, sopra un divano o sul tavolo da pranzo.

Hook is a customizable wall support that turns any lampshade of the ZAVA collection into an applique (including the suspension), as long as they operate at mains voltage. Hook is characterized by its rotating arm of almost 180° and variable in height and length according to need. Hook is a perfect system for lighting contract spaces but also for domestic environments: in a corridor, or over a dining table.

Paralumi disponibili Available lampshades

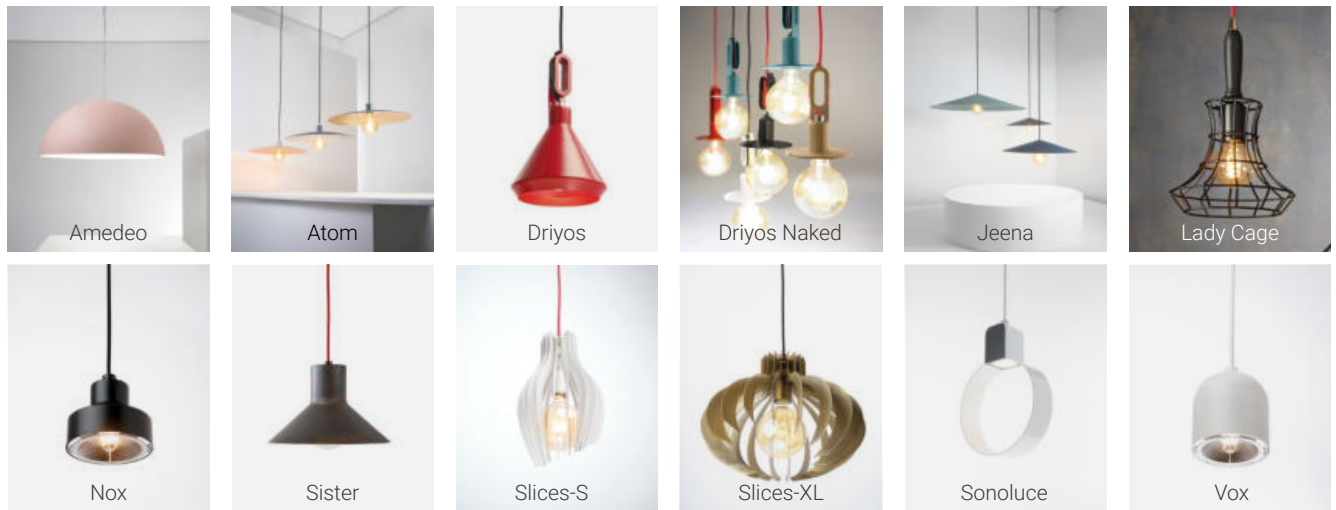

Sistema a parete Wall system

Paralume fisso · Fixed lampshade

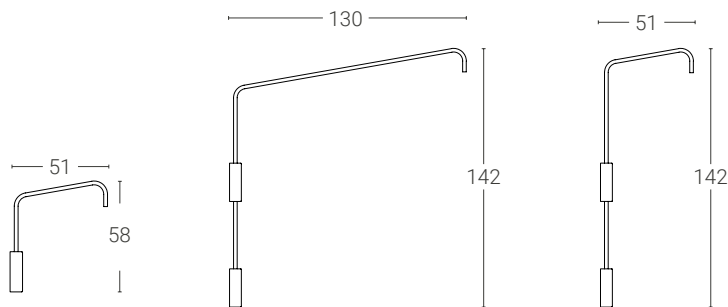

Paralume su cavo · Lampshade on cable

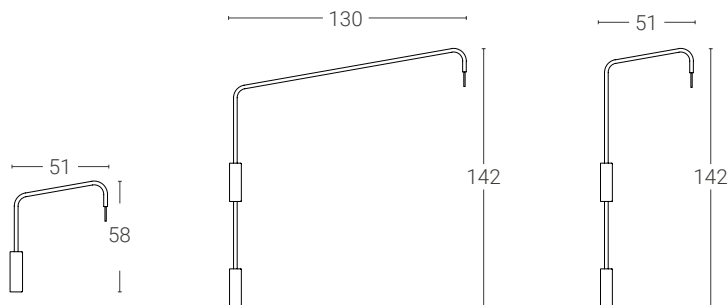

Materiale Material

Ferro
Iron

Finiture Colours

- RAL 9010
- RAL 9005
- Blu di laminazione Iron blu
- Sahara
- Verde salvia Sage green

Finiture disponibili solo in versione opaca
Finishes available only in matt version

Jeena

Design: Franco Zavarise



Jeena

Design: Franco Zavarise

Jeena è una famiglia molto flessibile di lampade caratterizzate da un importante paralume a forma di cono. La collezione comprende varie lampade a sospensione, di diametri e forme diverse, oltre ad una lampada da terra coordinabile.

Jeena is a very flexible family of lamps characterized by an important cone-shaped shade. The collection includes various suspension lamps of different diameters and shapes as well as a coordinable floor lamp.

JEENA Terra Floor (version A)

Sorgente luminosa Light source

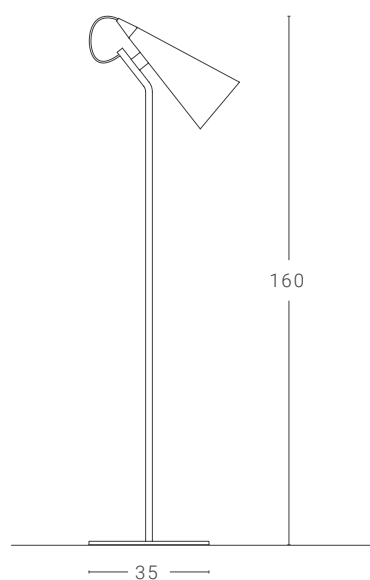

Attacco E27 (lampadina esclusa)
Max 70W
Lampholder E27 (bulb not included)
Max 70W

LED 1 x 17W 230V 3000K/4000K 1950Lm
Energy Class A
Driver ON/OFF incluso
ON/OFF driver included



Materiale Material

Ferro
Iron

Finiture Colours

- RAL 9010
- RAL 9005
- Moon stone
- Sahara
- Rosa quarzo
Quartz Pink
- Grigio diaspro Jasper grey
- Blu oceano Ocean blue
- Verde giungla Jungle green
- Verde salvia Sage green
- Verde artico Arctic green

Finitura interna Interior colour

Colore personalizzabile
su richiesta o foglia
oro / argento/ rame
Any colour on demand or
golden / silver / copper leaf

Finiture disponibili solo in versione opaca
Finishes available only in matt version

Jeena

Design: Franco Zavarise

JEENA Terra Floor (version B)

Sorgente luminosa Light source

LED · LED: 17W 2300Lm 3000K
ON/OFF
Dimmable

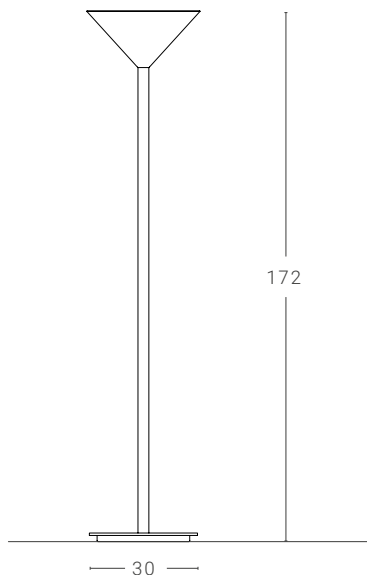

Materiale Material

Ferro Iron

Finiture Colours

○ RAL 9010

● RAL 9005

● Verde salvia
Sage green

● Sahara

● Matt silk grey
RAL 7044

● Bronzo metallizzato
Metalized bronze

Cavo Cable

● Rayon nero Black rayon







JEENA Parete Wall light

Sorgente luminosa Light source

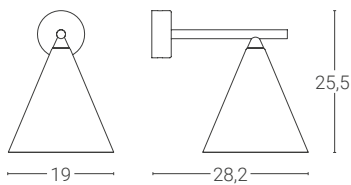

Attacco E14 (lampadina esclusa)
Max 42W
Lampholder E14 (bulb not included)
Max 42W

Materiale Material

Ferro Iron

Finiture Colours

- RAL 9010
- RAL 9005
- Verde salvia
Sage green
- Sahara
- Matt silk grey
RAL 7044
- Bronzo metallizzato
Metalized bronze

Finitura interna Interior colour

Colore personalizzabile
su richiesta o foglia
oro / argento/ rame
Any colour on demand or
golden / silver / copper leaf

Jeena sospensione - Versione A

Jeena suspension - Version A

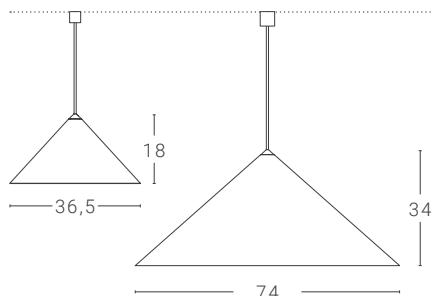

Dim. rosone: Ø 11 cm altezza 12 cm
Ceiling rose dim.: Ø 11 cm height 12 cm

Sorgente luminosa Light source

Ø 36,5 / 74 cm:

Attacco E27 (lampadina esclusa) Max 70W
Lampholder E27 (bulb not included)
Max 70W

Ø 36,5 cm:

LED 1 x 17W 230V 3000K1950Lm Energy Class A
Driver ON/OFF incluso / Disponibile driver
dimmerabile DALI/PUSH su richiesta
ON/OFF driver included / DALI/PUSH dimmable
driver available on request

Ø 74 cm:

LED 1 x 28,5W 230V 3000K 3060Lm Energy Class A
Driver ON/OFF incluso / Disponibile driver
dimmerabile DALI/PUSH su richiesta
ON/OFF driver included / DALI/PUSH dimmable
driver available on request



Jeena sospensione - Versione B

Jeena suspension - Version B

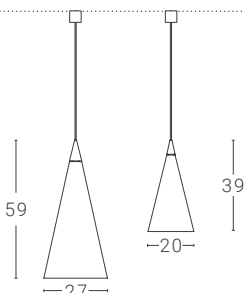

Dim. rosone: Ø 7,5 cm altezza 7 cm
Ceiling rose dim.: Ø 7,5 cm height 7 cm

Sorgente luminosa Light source

Ø 20 / 27 cm:

Attacco E27 (lampadina esclusa) Max 70W
Lampholder E27 (bulb not included)
Max 70W

Ø 27 cm:

LED 1 x 25W 230V 3000/4000K 3060Lm En. Class A
Driver ON/OFF incluso / Disponibile driver
dimmerabile DALI/PUSH su richiesta
ON/OFF driver included / DALI/PUSH dimmable
driver available on request



Materiale Material

Ferro
Iron

Finiture esterne Outside colours

○ RAL 9010

● RAL 9005

● Moon stone

● Sahara

● Rosa quarzo
Quartz Pink

● Grigio diaspro Jasper grey

● Blu oceano Ocean blue

● Verde giungla Jungle green

● Verde salvia Sage green

● Verde artico Arctic green

Finiture interne Inside colours

Vedi tabella colori.
See colour chart.

Finiture disponibili solo in versione opaca
Finishes available only in matt version





Jeena

Design: Franco Zavarise

Jeena sospensione - Versione C
Jeena suspension - Version C

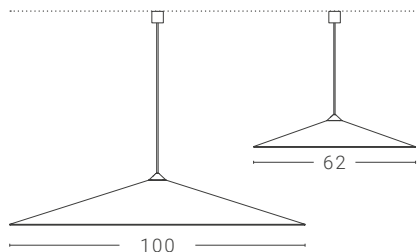

Sorgente luminosa Light source

Attacco E27 (lampadina esclusa)
Max 70W
Lampholder E27 (bulb not included)
Max 70W

Dim. rosone: Ø 11 cm altezza 12 cm
Ceiling rose dim.: Ø 11 cm height 12 cm



Materiale Material

Ferro
Iron

Finiture esterne Outside colours

- RAL 9010
- Grigio diaspro Jasper grey
- RAL 9005
- Blu oceano Ocean blue
- Moon stone
- Verde giungla Jungle green
- Sahara
- Verde salvia Sage green
- Rosa quarzo
Quartz Pink
- Verde artico Arctic green

Finiture interne Inside colours

Vedi tabella colori.
See colour chart.

Finiture disponibili solo in versione opaca
Finishes available only in matt version

Lady Cage

Design: Massimo Rosati

L'ispirazione è la vecchia lampada da officina. La ruvida "cage lamp" veste il più classico dei paralumi e sogna di essere una vera Lady. Per l'occasione, l'abito nero è d'obbligo, ma è disponibile anche nelle versioni bianca e cromo.

Inspired by the old-fashioned workshop light. The rough "cage lamp" shows off the most classic of shades and dreams of being a real Lady. A black outfit is a must for the occasion, but it is also available in white and chrome versions.





LADY CAGE Sospensione Suspension

Sorgente luminosa Light source

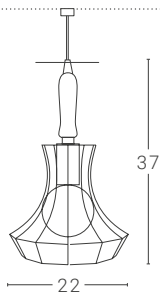

Attacco E27 (lampadina esclusa)
Max 70W
Lampholder E27 (bulb not included)
Max 70W

Lunghezza cavo: 1,5 m
Cable length: 1,5 m

Dim. rosone: Ø 4,5 cm altezza 7 cm
Ceiling rose dim.: Ø 4,5 cm height 7 cm

Disponibile anche versione outdoor
Outdoor version available

LADY CAGE Tavolo Table

Sorgente luminosa Light source

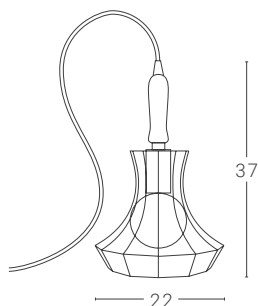

Attacco E27 (lampadina esclusa)
Max 70W
Lampholder E27 (bulb not included)
Max 70W

Lunghezza cavo: 3 m
Cable length: 3 m

LADY CAGE Parete Wall light

Sorgente luminosa Light source

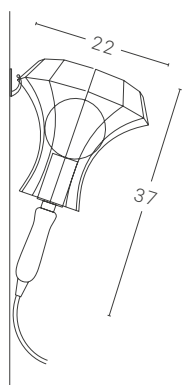



Attacco E27 (lampadina esclusa)
Max 70W
Lampholder E27 (bulb not included)
Max 70W

Lunghezza cavo: 3 m
Cable length: 3 m

Materiale Material

Struttura in ferro, manico
in plastica nera
Iron structure, black plastic handle

Finiture Colours

-  RAL 9010
-  Nero raggrinzante
Wrinkled black
-  Cromo Chrome

Finiture disponibili solo in versione opaca
Finishes available only in matt version

Finiture cavo Cable colours

Colore a scelta (vedi tabella colori).
Colour on demand
(see cables colour chart).





Queen Cage

Design: Massimo Rosati



QUEEN CAGE

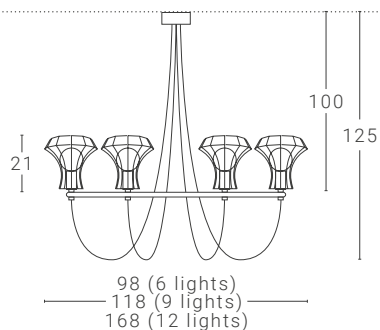

Sorgente luminosa Light source

Attacco E27 (lampadina esclusa)
Max 6/9/12 x 70W
Lampholder E27 (bulb not included)
Max 6/9/12 x 70W

Dim. rosone: Ø 22 cm altezza 4,5 cm
Ceiling rose dim.: Ø 22 cm height 4,5 cm

Materiale Material

Struttura in ferro
Iron structure

Finiture Colours

○ RAL 9010

● RAL 9005

Finiture disponibili solo in versione opaca
Finishes available only in matt version

Finiture cavo Cable colours

Colore a scelta (vedi tabella colori).
Colour on demand
(see cables colour chart).

Linfa

Design: Debonademeo

Una famiglia di lampade ispirate al concetto di “dare alla luce”, espressione universale che abbina il concetto di nascita a quello di sorgente luminosa. Ogni modello della collezione è caratterizzato da fasci di tubi curvati che, come capillari linfatici, si articolano nello spazio abitato disegnando nell’aria arabeschi metallici. Le estremità di ogni tubo si espande in sfere di vetro opalino che si accendono per illuminare gli ambienti. Lampade a sospensione, applique e piantane prendono a modello il tradizionale chandelier per ridefinirlo in chiave contemporanea, al tempo stesso minimalista e romantica.

A family of lamps that combines the concept of birth and light source. Each model in the collection is characterised by curved tubes that, like lymphatic capillaries, articulate in the inhabited space, drawing metallic arabesques in the air. At the ends of each tube expand opal glass spheres that light up to illuminate the rooms. Pendant lamps, wall lamps and floor lamps take the traditional chandelier as a model to redefine it in a contemporary key, at once minimalist and romantic.



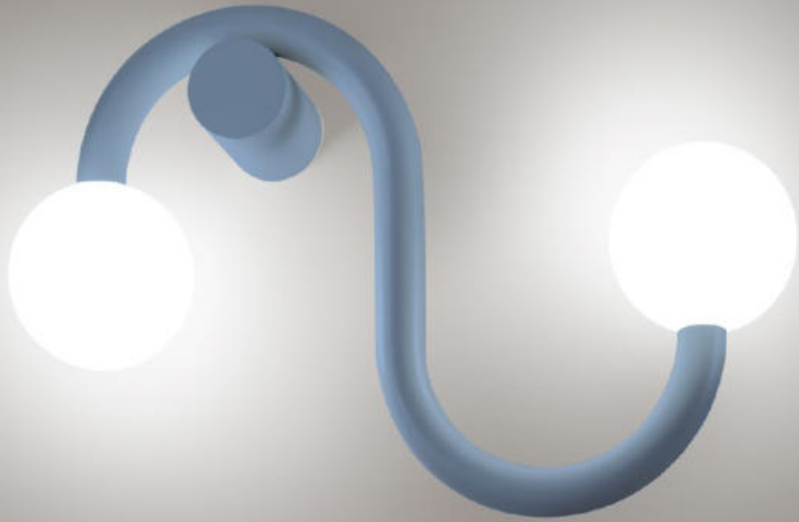

LINFA Parete Wall light

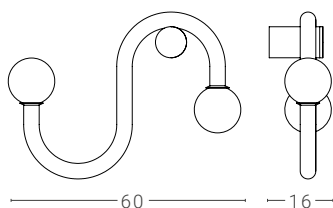

Sorgente luminosa Light source

Attacco G9 (lampadina esclusa)
Max 12W
Lampholder G9 (bulb not included)
Max 12W

LINFA Sospensione Suspension

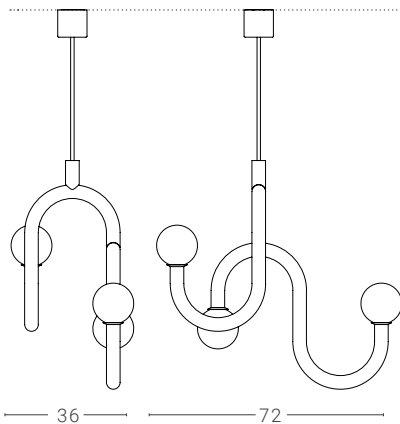

Sorgente luminosa Light source

Attacco G9 (lampadina esclusa)
Max 12W
Lampholder G9 (bulb not included)
Max 12W

Materiale Material

Ferro, vetro
Iron, glass

Finiture Colours

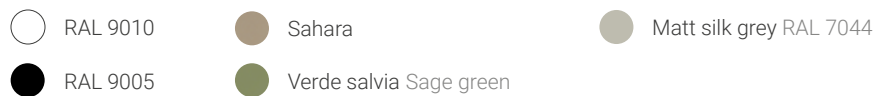

Finiture disponibili solo in versione opaca
Finishes available only in matt version

Loola

Design: BrogliatoTraverso

Un grande cerchio di luce, una forma pura ed essenziale custodita dal delicato abbraccio dei due anelli che ne fanno da cornice. Loola ha un driver dimmerabile standard DALI, PUSH, 0-10V, 1-10V.

Adatta ad ogni tipo d'ambiente, Loola è disponibile come sospensione, plafoniera a soffitto o da parete.

A large circle of light, a pure and minimal shape guarded by the delicate embrace of the two rings that encircle it. Loola has a standard DALI, PUSH, 0-10V, 1-10V dimmable driver. Suitable for any type of environment, Loola is available as a pendant, ceiling flush light, or wall sconce.

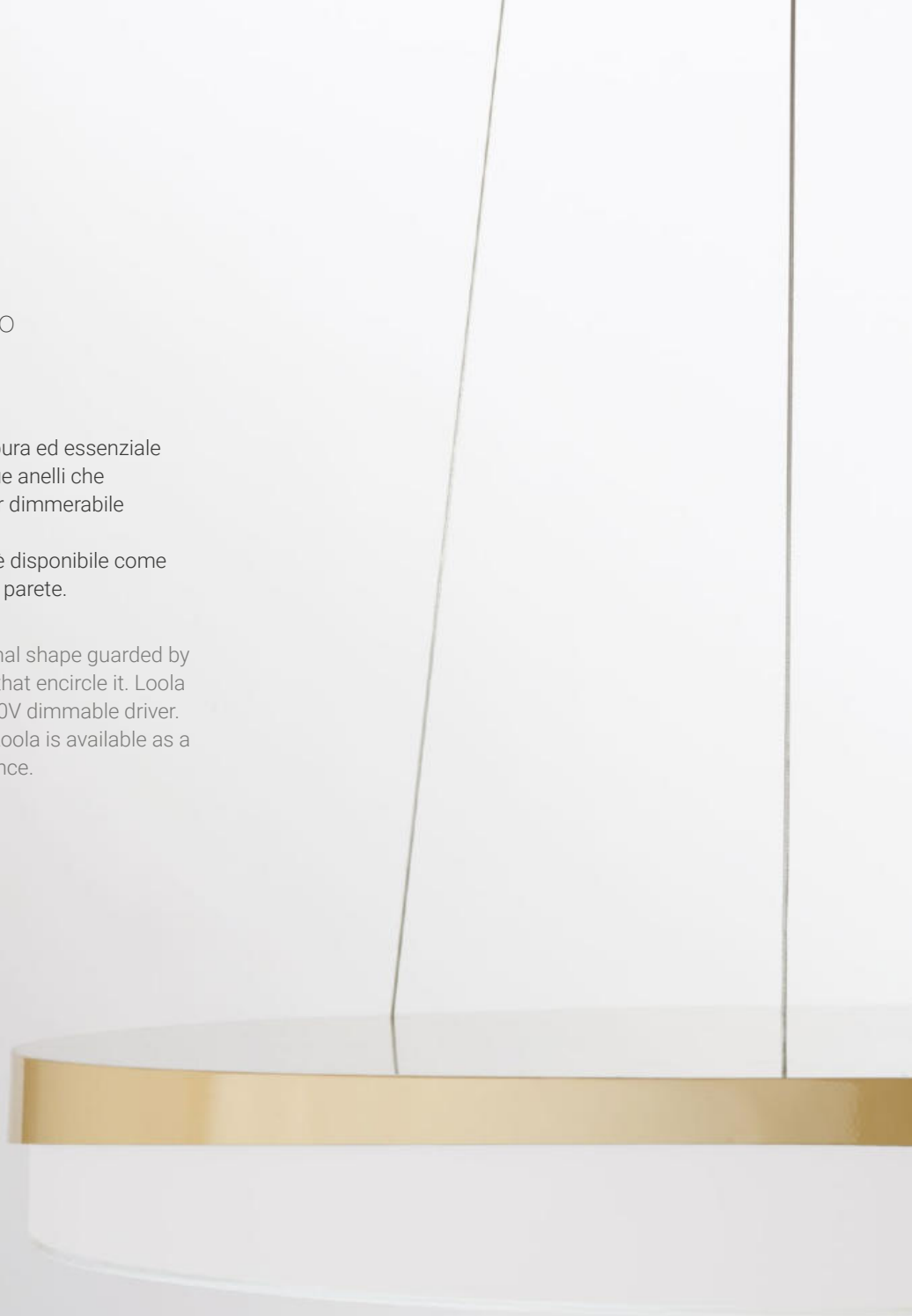





LOOLA Sospensione Suspension

Sorgente luminosa Light source

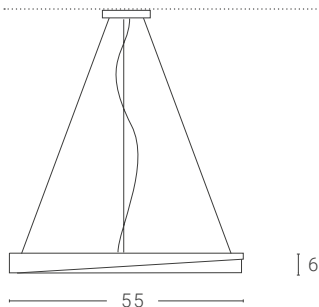

LED 1 x 31,5W 230V 3000K 4000Lm
Energy Class A

Dimmerabile DALI, Push, 0-10V, 1-10V
Dimmable DALI, Push, 0-10V, 1-10V

Dim. rosone: Ø 20 cm altezza 5 cm
Ceiling rose dim.: Ø 20 cm height 5 cm

LOOLA Plafoniera Ceiling light

Sorgente luminosa Light source

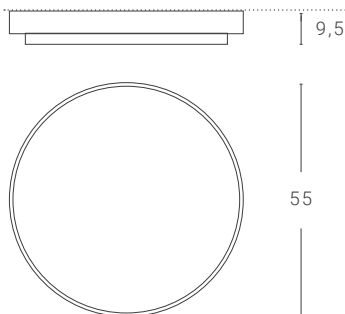

LED 1 x 31,5W 230V 3000K 4000Lm
Energy Class A

Dimmerabile DALI, Push, 0-10V, 1-10V
Dimmable DALI, Push, 0-10V, 1-10V

LOOLA Parete Wall light

Sorgente luminosa Light source

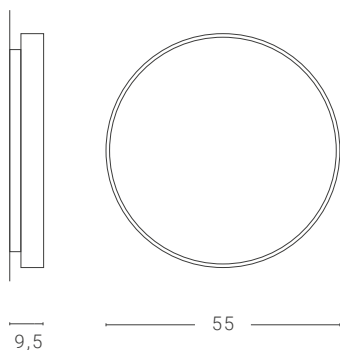

LED 1 x 31,5W 230V 3000K 4000Lm
Energy Class A

Dimmerabile DALI, Push, 0-10V, 1-10V
Dimmable DALI, Push, 0-10V, 1-10V

Materiale Material

Ferro, plexiglass
Iron, plexiglass

Finiture Colours

- RAL 9010
- RAL 7006
- RAL 9005
- * Ottone Brass
- Blu di laminazione Iron blu

Finiture disponibili solo in versione opaca
Finishes available only in matt version

* Non disponibile ottone spazzolato
* Not available brushed brass

Flow
Design Valerio Cometti +
V12 deisgn

Pag. 95



Jeena
Design Franco Zavarise

Pag. 99

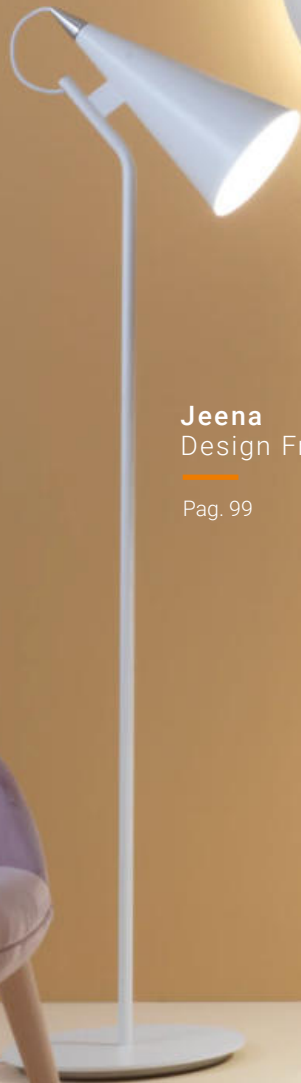

Rei
Design Alessandro Zambelli

Pag. 181



Rei
Design Alessandro Zambelli

Pag. 181

Etrè
Design Alberto Caramello

Pag. 85

Mark

Design: Franco Zavarise

Mark è una lampada tecnica e decorativa al tempo stesso. Tecnica, per la sua potente luce a LED che illumina a spot. Decorativa, per la sua forma geometrica semplice ma decisa. Un volume importante che non passa inosservato e che rivendica la sua presenza nello spazio.

Mark is a technical and decorative lamp at the same time. It is technical for its powerful LED light that illuminates as a spot light. It is decorative for its simple but decisive geometric shape. An important volume that does not pass inobserved and which determines its presence in space.

Sospensione Suspension

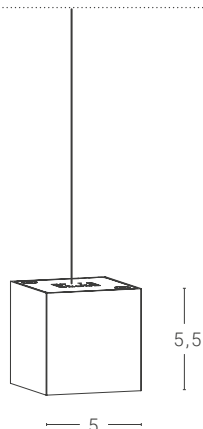

Dim. rosone: altezza 8 cm
Ceiling rose dim.: height 8 cm

Le dimensioni del rosone nella variante DALI/PUSH possono essere diverse
The dimensions of the ceiling rose in DALI /PUSH variant can be different

Sorgente luminosa Light source

1 x 4W 230V 2700K/3000K 380Lm CRI>90 Energy Class A

Angoli di emissione disponibili: 25°, 40°, 60°
Available emission angles: 25°, 40°, 60°

Driver ON/OFF incluso / Disponibile driver dimmerabile DALI/PUSH su richiesta
ON/OFF driver included / DALI/PUSH dimmable driver available on request

Materiale Material

Alluminio o ottone
Aluminium or brass

Finiture Colours

○ RAL 9010

● Ottone Brass

● RAL 9005

Finiture disponibile solo in versione opaca
Finishes available only in matt version





Meridium

Design: De Bona.De Meo

Luce come strumento di misurazione del tempo. Una collezione di lampade ispirate alle antiche meridiane: l'orologio solare riappare come lampada da interni. Il nuovo contesto sovverte il rapporto tra ombra e luce: il quadrante si trasforma in un disco e lo gnomone lascia il posto a un profilo in metallo, che diventa esso stesso vettore di luce. Il fruitore diventa artefice, spostando a piacere la sorgente luminosa magnetica per orientare il flusso e creare chiaroscuri sempre diversi sulla superficie della lampada. Meridium è disponibile anche nella finitura Lavagna, scrivibile con i normali gessetti.

Light as a tool for measuring time. A collection of lamps inspired by ancient sundials: the solar clock reappears as a lighting object for interior. The new context subverts the relationship between shadow and light: the dial turns into a disk and the gnomon gives way to a metal profile, which itself becomes a light vector. The end-user is becoming master and creator of his own lamp, moving the magnetic light source at will to direct the flow and create ever-changing light and shade effects on the surface of the lamp. Meridium is also available in the Blackboard finish, which can be written with normal chalks.

Parete Wall light

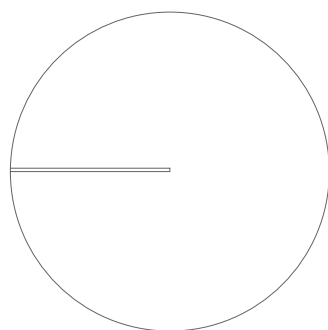

A: 50
B: 60
C: 95

Sorgente luminosa Light source

Versione A Version A:

LED 1 x 3W 230V 3000K 330Lm Energy class A

Versione B Version B:

LED 1 x 4W 230V 3000K 420Lm Energy class A

Versione C Version C:

LED 1 x 8W 230V 3000K 750Lm Energy class A

Alimentatore ON/OFF incluso
ON/OFF power supply included

Materiale Material:

Ferro, alluminio
Iron, aluminium

Finiture Colours:

● Ecomalta® effetto lavagna
Ecomalta® blackboard effect

○ Ecomalta® bianca
Ecomalta® white

● Ecomalta® rossa
Ecomalta® red

○ RAL 9010

● RAL 9005

● Ottone Brass

Finiture disponibili solo in versione opaca
Finishes available only in matt version

Meta

Design: Franco Zavarise

Pochi segni, linee pure, pulizia delle forme, geometrie elementari: un disco circolare, un anello, un cilindro, raccordati tra loro da un braccio tubolare piegato ad angolo retto. Meta riprende l'essenzialità del tradizionale design scandinavo, declinandola con uno sguardo contemporaneo e con le ultime tecnologie a LED.

Meta has few marks, clean lines, an elementary structure: a circular disc, a ring, a cylinder, all gathered together by a tube-shaped arm that is bent to a right angle. Meta captures the essential nature of scandinavian design and adds a contemporary touch by using the latest LED technology.







Sospensione A Suspension A

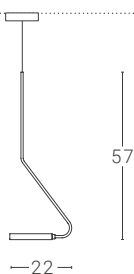

Dim. rosone: Ø 16 cm altezza 4 cm
Ceiling rose dim.: Ø 16 cm height 4 cm

Sorgente luminosa Light source

LED 1 x 18,5W 230V 3000K 2450Lm. Energy Class A

Driver dimmerabile DALI/PUSH incluso
DALI/PUSH dimmable driver included

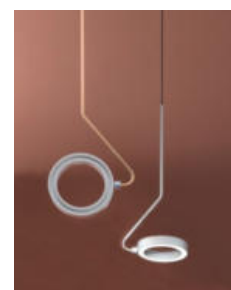

Sospensione B Suspension B

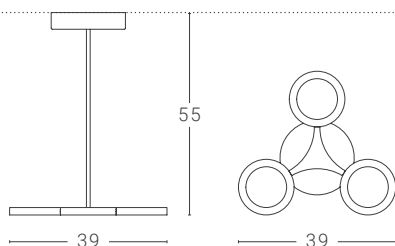

Dim. rosone: Ø 20 cm altezza 4 cm
Ceiling rose dim.: Ø 20 cm height 4 cm

Sorgente luminosa Light source

LED 3 x 12W 230V 3000K 1700Lm. Energy Class A

Driver dimmerabile DALI/PUSH incluso
DALI/PUSH dimmable driver included



Materiale Material

Sospensione A: ferro, alluminio, ottone
Suspension: iron, aluminium, brass

Sospensione B: ferro, alluminio
Suspension B: iron, aluminium

Finiture Colours

○ RAL 9010

● RAL 9005

● RAL 7006

● Blu oceano Ocean blue

● Sahara

● Ottone Brass *

● Verde artico Arctic green

Finiture disponibili solo in versione opaca
Finish available only in matt version

* Finiture disponibili solo per sospensione A
* Finish available only for suspension A

Meta

Design: Franco Zavarise

Parete rotonda Circle wall light

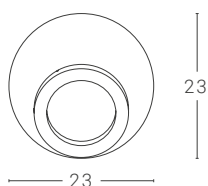

Sorgente luminosa Light source

LED 1 x 18,5W 230V 3000K 2450Lm. Energy Class A

Driver dimmerabile DALI/PUSH incluso
DALI/PUSH dimmable driver included

Parete quadrata Square wall light

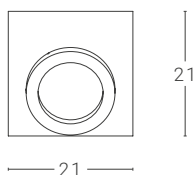

Sorgente luminosa Light source

LED 1 x 18,5W 230V 3000K 2450Lm. Energy Class A

Driver dimmerabile DALI/PUSH incluso
DALI/PUSH dimmable driver included

Parete rettangolare Rectangular wall light

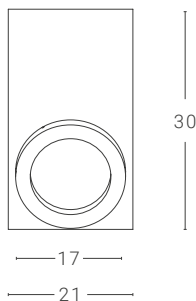

Sorgente luminosa Light source

LED 1 x 18,5W 230V 3000K 2450Lm. Energy Class A

Driver dimmerabile DALI/PUSH incluso
DALI/PUSH dimmable driver included

Materiale Material

Ferro, alluminio
Iron, aluminium

Finiture Colours

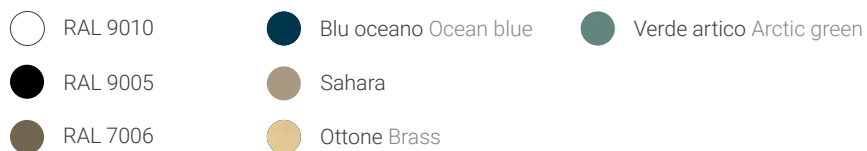

Finiture disponibili solo in versione opaca
Finish available only in matt version



Meta

Design: Franco Zavarise



META Tavolo Table

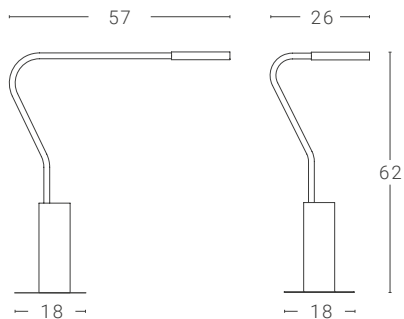

Sorgente luminosa Light source

LED 1 x 8W 230V 3000K 1000Lm. Energy Class A

Dimmerabile DALI/PUSH / DALI/PUSH Dimmable



META Parete Wall light

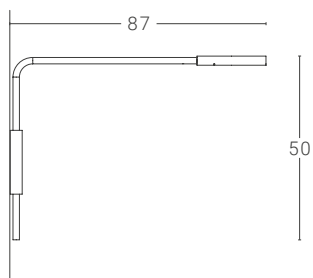

Sorgente luminosa Light source

LED 1 x 18,5W 230V 3000K 2450Lm Energy Class A

Driver dimmerabile DALI/PUSH incluso
DALI/PUSH dimmable driver included

Lampada orientabile sulla base
Orientable fitting on the base



Materiale Material

Ferro, ottone, alluminio
Iron, brass, aluminium

Nella variante ottone, base e disco sono disponibili solo in RAL 9010 e RAL 9005 opachi.

For brass version, disc and ring are available only in RAL 9010 and RAL 9005 matt version.

Finiture Colours

○ RAL 9010

● RAL 9005

● RAL 7006

● Blu oceano Ocean blue

● Sahara

● Ottone Brass

● Verde artico Arctic green

Finiture disponibili solo in versione opaca
Finish available only in matt version



META Terra Floor

Sorgente luminosa Light source

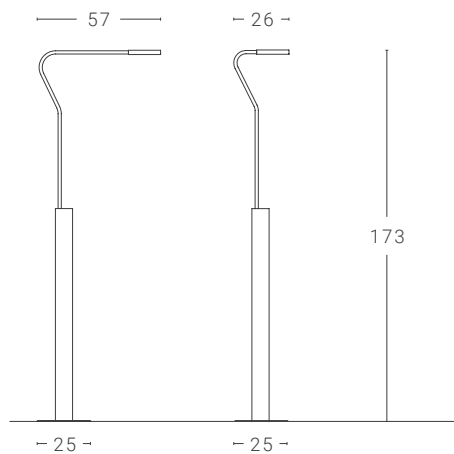

LED 1 x 18,5W 230V 3000K 2450Lm Energy Class A

Dimmerabile DALI/PUSH / DALI/PUSH Dimmable

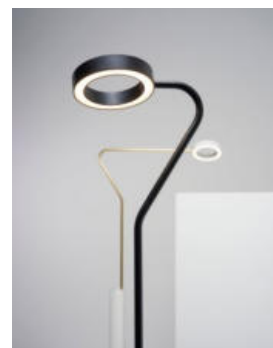

Materiale Material

Ferro, ottone, alluminio
Iron, brass, aluminium

Nella variante ottone, base e disco sono disponibili solo in RAL 9010 e RAL 9005 opachi.
For brass version, disc and ring are available only in RAL 9010 and RAL 9005 matt version.

Finiture Colours

○ RAL 9010

● RAL 9005

● RAL 7006

● Blu oceano Ocean blue

● Sahara

● Ottone Brass

● Verde artico Arctic green

Finiture disponibili solo in versione opaca
Finish available only in matt version

Mini Mini

Design: Franco Zavarise

Delicata fonte luminosa, come una piccola ma lucente stella nel cielo, Mini Mini nasce per essere integrata nel giardino. È la coniugazione di funzionalità e rispetto dell'ambiente, in quanto Mini Mini non genera inquinamento luminoso e soprattutto si mimetizza nell'ambiente naturale grazie anche alla finitura ramata. L'esile stelo permette inoltre di dare a Mini Mini l'inclinazione desiderata.

A gentle light source, such as a small but shining star in the sky, Mini Mini is designed to be integrated into the garden. It is the conjugation of functionality and respect for the environment, as Mini Mini does not generate light pollution and mostly blends into the natural environment thanks to the copper finish. The slender stem allows to get to Mini Mini the desired angle and shape.

Esterno Outdoor

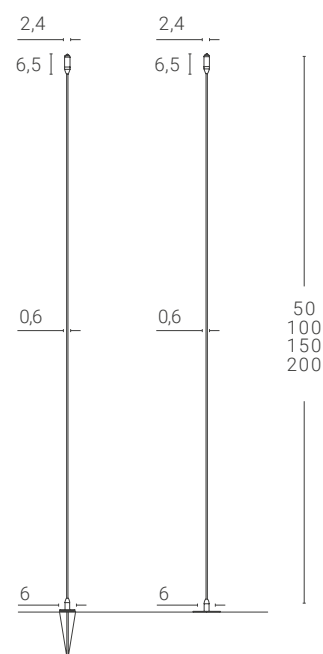

Sorgente luminosa Light source

1 x 1,5W G4 LED CERAMIC 12V 2700K
85Lm Energy class A

Alimentatore escluso /
A richiesta disponibile alimentatore da installare
remoto in apposita scatola di derivazione
impermeabile, non fornita da ZAVA.
Power supply excluded /
On request, a power supply unit is available to be
installed remotely in a special waterproof junction
box, not supplied by ZAVA.

Dettaglio picchetto
Picket detail



Diffusore in vetro o silicone
Glass or silicone diffuser

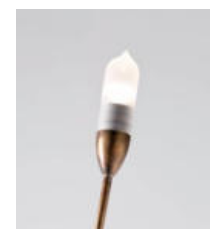

Materiale Material

Ottone, punto luce in vetro,
picchetto acciaio inox.
Brass, light point in glass,
stainless steel picket.

Finiture Colours

- Brunito satinato chiaro
Light satined burnished
- Brunito satinato scuro
Dark satined burnished
- Verde rame
Copper green

Finiture disponibili solo in versione opaca
Finishes available only in matt version





Nefertari

Design: Lorenzo Palmeri

Nefertari è una lampada a parete di grandi dimensioni che riprende l'archetipo, sogno mai esaurito, di avere un corpo illuminante vagante nello spazio. Nefertari funziona con un sistema a leva che sfrutta il suo stesso peso per sostenersi in contrasto alla parete. È possibile allontanare o avvicinare il corpo illuminante alla parete con un semplice gesto, facendo scorrere lo stelo nel manicotto.

Disponibili versione a parete e a soffitto.

Nefertari is a large wall lamp that follows the archetype, dream never exhausted, to have an illuminating body wandering in space. Nefertari works with a lever system that uses its own weight to sustain itself in contrast to the wall. It is possible to move the illuminating body closer or far to the wall with a simple gesture, by sliding the stem into the sleeve. Wall and ceiling versions available.

Parete Wall light

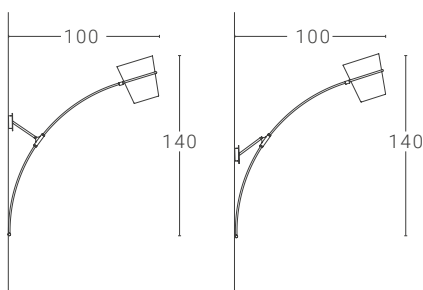

Sorgente luminosa Light source

Attacco E27 (lampadina esclusa)
Max 70W
Lampholder E27 (bulb not included)
Max 70W

Plafoniera Ceiling light

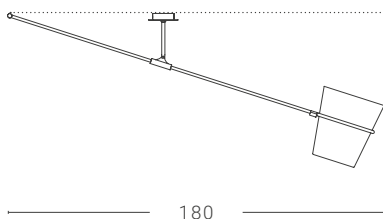

Sorgente luminosa Light source

Attacco E27 (lampadina esclusa)
Max 70W
Lampholder E27 (bulb not included)
Max 70W

Materiale Material

Ferro, ottone, alluminio
Iron, brass, aluminium

Finiture esterne Outside colours

- RAL 9010
- Grigio basalto Basalt grey
- RAL 9005
- Verde giungla Jungle green

Finiture disponibili solo in versione opaca
Finishes available only in matt version

Finiture interne Inside Colours

Vedi tabella colori.
See colour chart.



Net

Design: Paolo Ulian

Net è una lampada in lamiera di acciaio dalla forte vocazione scultorea. Il diffusore è realizzato partendo da una lamiera piana di acciaio tagliata al laser secondo delle linee concentriche alternate: queste la trasformano in un fitto reticolo modellabile a mano che permette di ottenere infinite soluzioni formali del diffusore. Può assumere forme semplici e pure per adattarsi ad ambienti discreti e minimali oppure forme geometriche complesse e scultoree per caratterizzare e arricchire abitazioni o spazi pubblici. Quando è accesa proietta un piacevole gioco decorativo sulle pareti. Disponibile nelle versioni a sospensione, da terra e da tavolo.

Net is a lamp in sheet steel with a strong sculptural inclination. The diffuser is made from a laser-cut flat steel sheet based on concentric, alternate lines. These transform it into a thick hand-modulable lattice that allows the diffuser to achieve infinite stylish solutions. It can assume simple, pure forms to adapt to discrete and minimal or complex geometric and sculptural environments giving character to and enriching homes or public spaces. When it is switched on it projects a pleasing decorative effect onto the walls. There are also pendant, floor and table versions.

Sagome disponibili per le cupole Available shapes for the domes

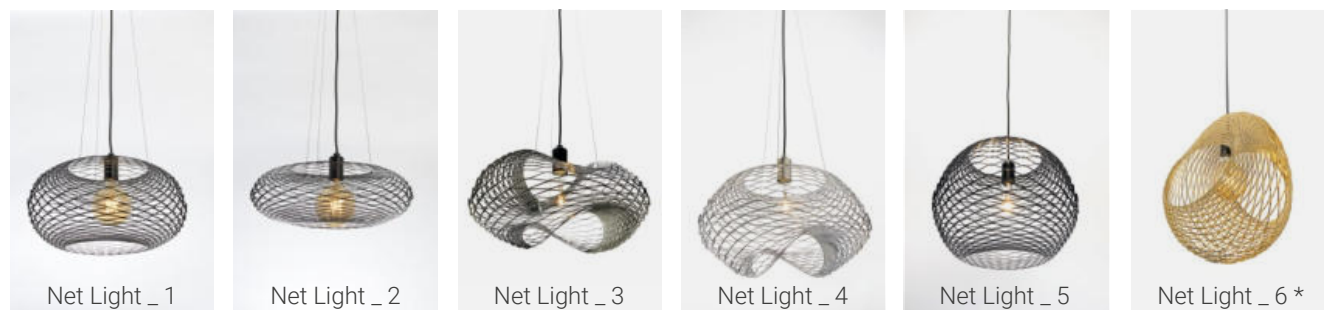

* disponibile solo per la sospensione da 50cm con sorgente luminosa singola

* only available for 50cm suspension with single light source

NET Sospensione Suspension

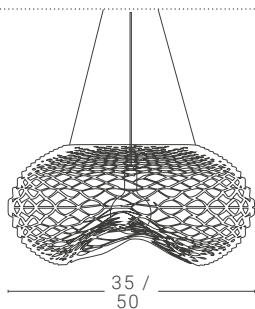

Dim. rosone: Ø 20 cm altezza 5 cm
Ceiling rose dim.: Ø 20 cm height 5 cm

Sorgente luminosa Light source

Attacco E27 (lampadina esclusa)
Max 70W
Lampholder E27 (bulb not included)
Max 70W

Dimensioni:
Ø 35 cm altezza 18 cm
Ø 50 cm altezza 25 cm
(variabili a seconda della forma).

Dimensions:
Ø 35 cm height 18 cm
Ø 50 cm height 25 cm
(variable dimensions depending on the shape)

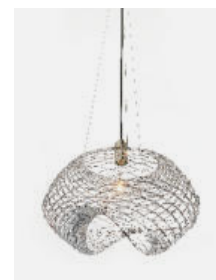

NET Terra Floor

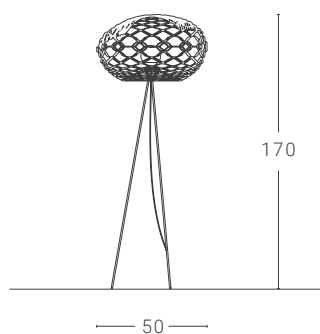

Sorgente luminosa Light source

Attacco E27 (lampadina esclusa)
Max 70W
Lampholder E27 (bulb not included)
Max 70W

Dimensioni: Ø 50 cm altezza 170 cm
(variabili a seconda della forma).
Dimensions: Ø 50 cm height 170 cm
(variable dimensions depending on the shape)



NET Tavolo Table

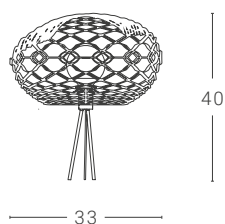

Sorgente luminosa Light source

Attacco E27 (lampadina esclusa)
Max 70W
Lampholder E27 (bulb not included)
Max 70W

Dimensioni: Ø 33 cm altezza 40 cm
(variabili a seconda della forma).
Dimensions: Ø 33 cm height 40 cm
(variable dimensions depending on the shape)



Materiale Material

Ferro
Iron

Finiture Colours

○ * RAL 9010

● * RAL 9005

● Cromo Chrome

● Oro Gold

● * Verde artico
Arctic green

Finiture cavo Cable colours

● Rayon nero Black rayon

Nelle versioni terra e tavolo con cupole a finitura cromo e oro la base è disponibile solo in nero opaco - RAL 9005.
For floor and table version with chrome and gold finish domes the base is available only in matt black - RAL 9005.

* Finiture disponibili solo in versione opaca
* Finishes available only in matt version









NET BIG

Sospensione 3 luci 3 bulbs suspension

Sorgente luminosa Light source

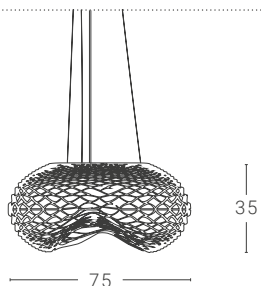

Attacco E27 (lampadina esclusa)
Max 3 x 70W
Lampholder E27 (bulb not included)
Max 3 x 70W

Dimensioni: Ø 75 cm altezza 35 cm
(dimensioni variabili a seconda della forma).
Dimensions: Ø 75 cm height 35 cm
(variable dimensions depending on the shape)



Dim. rosone: Ø 20 cm altezza 5 cm
Ceiling rose dim.: Ø 20 cm height 5 cm

NET BIG

Sospensione 5 luci 5 bulbs suspension

Sorgente luminosa Light source

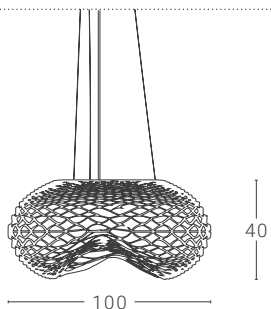

Attacco E27 (lampadina esclusa)
Max 5 x 70W
Lampholder E27 (bulb not included)
Max 5 x 70W

Dimensioni: Ø 100 cm altezza 40 cm
(dimensioni variabili a seconda della forma).
Dimensions: Ø 100 cm height 40 cm
(variable dimensions depending on the shape)



Dim. rosone: Ø 20 cm altezza 5 cm
Ceiling rose dim.: Ø 20 cm height 5 cm

NET BIG

Sospensione 10 luci 10 bulbs suspension

Sorgente luminosa Light source

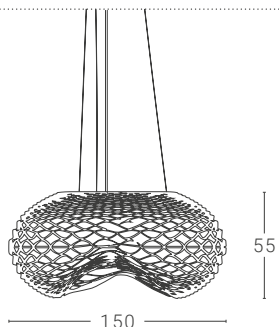

Attacco E27 (lampadina esclusa)
Max 10 x 70W
Lampholder E27 (bulb not included)
Max 10 x 70W

Dimensioni: Ø 150 cm altezza 55 cm
(dimensioni variabili a seconda della forma).
Dimensions: Ø 150 cm height 55 cm
(variable dimensions depending on the shape)



Dim. rosone: Ø 20 cm altezza 5 cm
Ceiling rose dim.: Ø 20 cm height 5 cm

Finitura oro e cromo non disponibile per la versione da 10 luci
Gold and chrome finishes are not available for the 10-lights fitting

Materiale Material

Ferro
Iron

Finiture Colours

- * RAL 9010
- Cromo Chrome
- * RAL 9005
- Oro Gold
- * Verde artico Arctic green

* Finiture disponibili solo in versione opaca
* Finishes available only in matt version

Finiture cavo Cable colours

- Rayon nero Black rayon

Nox

Design: Franco Zavarise



Si chiama Nox questa lampada a sospensione dalle dimensioni ridotte, perfetta per essere composta in grappoli grazie ai sistemi Ragi, Ragi-T e ZERO2.

Named Nox, this is a pendant lamp with reduced dimensions, perfect in cluster arrangements thanks to Ragi, Ragi-T and ZERO2 systems.

Sospensione Suspension

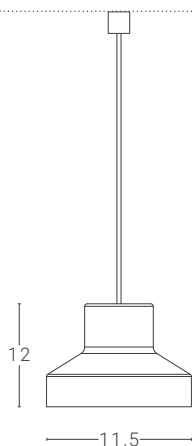

Dim. rosone: Ø 5,5 cm altezza 6 cm
Ceiling rose dim.: Ø 5,5 cm height 6 cm

Le dimensioni del rosone nella variante DALI/PUSH possono essere diverse
The dimensions of the ceiling rose in DALI /PUSH variant can be different

Sorgente luminosa Light source

Attacco GU10 Max 15W /
Lampholder GU10 Max 15W
Lampadina LED a tensione di rete /
LED mains voltage bulb
1 x 13W 230V 2700K 880Lm/950Lm
Energy Class A
Dimmerabile a taglio di fase solo con regolatori selezionati non forniti da ZAVA.
Phase-cut dimmable only with selected controllers not supplied by ZAVA.



LED 1 x 25W 230V 3000K 2450Lm CRI>90
Energy Class A
Driver ON/OFF incluso / Disponibile driver dimmerabile DALI/PUSH su richiesta
ON/OFF driver included / DALI/PUSH dimmable driver available on request



Materiale Material

Ferro, ottone
Iron, brass

Finiture Colours

-  RAL 9010
-  RAL 9005
-  Ottone Brass

Finiture disponibili solo in versione opaca
Finishes available only in matt version

Finiture cavo Cable colours

Colore a scelta (vedi tabella colori).
Colour on demand (see cables colour chart).
Versione LED: cavo in PVC
LED version: PVC cable
Versione GU10: Rayon nero
GU10 version: Black rayon



Ociu

Design: Franco Zavarise



Sospensione di grandi dimensioni (diametro 185 cm) in metacrilato opale bianco o nero con dettagli in alluminio verniciato. All'interno presenta un diffusore a forma di globo di diametro 50 cm in polimetacrilato. Finitura interna personalizzabile nei colori a catalogo e in foglia oro / argento / rame.

A large-sized suspension lamp (185 cm diameter) in opal white or black methacrylate with details in painted aluminium. In the inside the fitting has a polymethacrylate diffuser in a globe shape cm 50. The inner finish is customizable in any color of the catalogue, as well as in golden / silver / copper leaf.

Sospensione Suspension

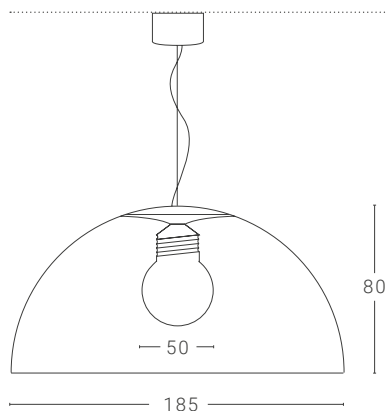

Sorgente luminosa Light source

Attacco E27 (lampadina esclusa)
Max 1 x 150W /
Lampholder E27 (bulb not included)
Max 1 x 150W



Dim. rosone: Ø 36 cm altezza 7 cm
Ceiling rose dim.: Ø 36 cm height 7 cm

Materiale Material

Metacrilato, ferro
Methacrylate, iron

Finiture esterne Outside colours

- RAL 9010 Bianco opale
Opal white
- RAL 9005 Nero opale
Opal black

Finiture interne Inside colours

Vedi tabella colori.
See cables colour chart.

Finiture disponibili solo in versione opaca
Finishes available only in matt version



Officina

Design: Franco Zavarise & Massimo Rosati

La lampada Officina nasce dall'incontro fra due creativi uniti da passioni comuni: le archeologie industriali e le vecchie lampade da lavoro. Il risultato è una lampada dalle linee "ruvide" ma evocative; ispirata alle vecchie officine, ma pensata per tutte le "officine contemporanee".

The lamp Officina was born from the fellowship meeting between two designers united by common passions: the industrial archeology and the old style working lanterns. The result is a lamp with a "rough" but evocative shape, inspired to the old industrial shops atmosphere, but designed for all the "contemporary workshops".

Sospensione Suspension

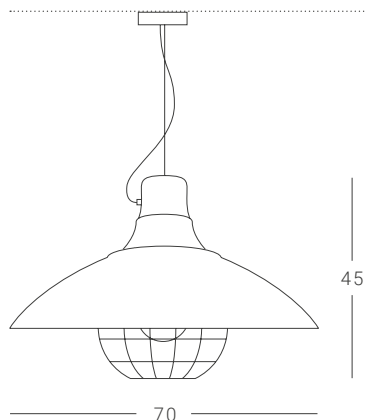

Sorgente luminosa Light source

Attacco E27 (lampadina esclusa)
Max 105W
Lampholder E27 (bulb not included)
Max 105W

Dim. rosone: Ø 24 cm altezza 5 cm
Ceiling rose dim.: Ø 24 cm height 5 cm

Materiale Material

Ferro
Iron

Finiture Colours

- RAL 9010
- RAL 9005
- Blu di laminazione Iron blu

Finiture disponibili solo in versione opaca
Finishes available only in matt version

Cavo pvc Pvc cable

- Nero Black





Orizzonte

Design: Cédric Davies

Orizzonte è un sistema di illuminazione che mi riporta all'infanzia. A quei tempi avevo la fortuna di giocare con un modellino ferroviario con cui potevo spaziare all'infinito e in tutte le direzioni. E a volte anche all'orizzonte. Molti anni dopo, ho avuto la fortuna di progettare una lampada con cui è possibile raggiungere l'orizzonte in modo elegante e giocoso, il che mi rende molto felice.

Orizzonte is a lighting system that takes me back to my childhood. Back then, I was lucky enough to play with a model railway. Here, I could roam endlessly in all directions. And sometimes even to the horizon. Many years later, I had the opportunity to design a lamp that allows you to reach the horizon in an elegant and playful way, which makes me very happy.





Orizzonte Sospensione Suspension

Sorgente luminosa Light source

Attacco E14 (lampadina esclusa)
Max 42W
Lampholder E14 (bulb not included)
Max 42W

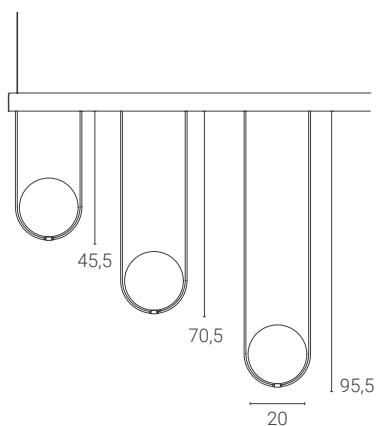
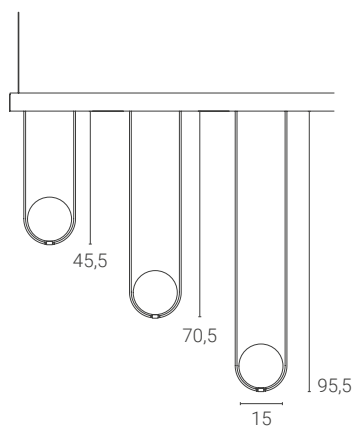

Orizzonte Sospensione vaso Vase suspension

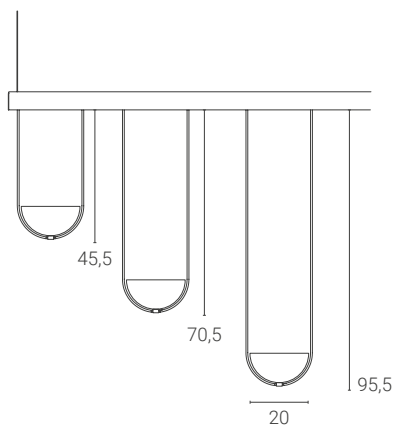
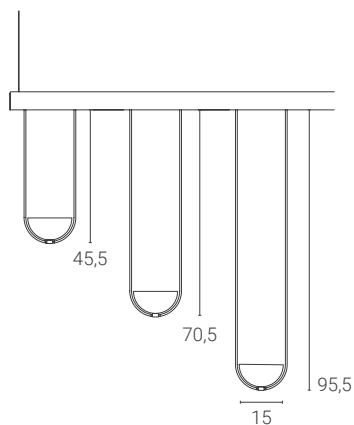

Materiale Material

Ferro, ottone, vetro
Iron, brass, glass

Finiture Colours

- RAL 9010
- RAL 9005
- Oro opaco a polvere
Matte gold

Finiture disponibili solo in versione opaca
Finishes available only in matt version

Pato

Design: Franco Zavarise

Un tratto materico e minimale disegna lo spazio.
Uno stelo in rame che si può piegare a piacere per creare
la silhouette preferita. Un'atmosfera vintage per una lampada
di grande effetto decorativo.

A tactile and minimal line that outlines the space.
A copper rod that can be bent as desired to create the
preferred silhouette. A vintage atmosphere offered by
a lamp that provides an impressive, decorative effect.



PATO Parete Wall light

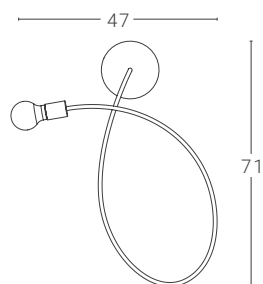

Misure indicative.
Indicative dimensions.

Sorgente luminosa Light source

Attacco E27 (lampadina esclusa)
Max 70W
Lampholder E27 (bulb not included)
Max 70W

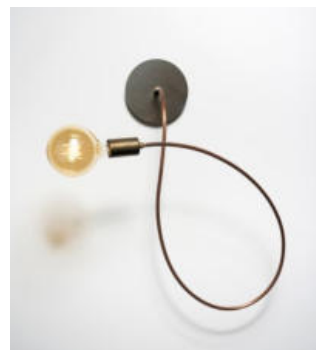

PATO Plafoniera Ceiling light

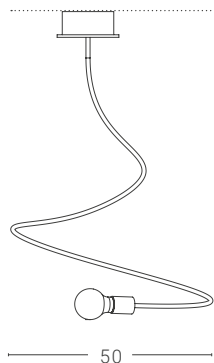

Misure indicative.
Indicative dimensions.

Sorgente luminosa Light source

Attacco E27 (lampadina esclusa)
Max 70W
Lampholder E27 (bulb not included)
Max 70W



PATO Terra Floor

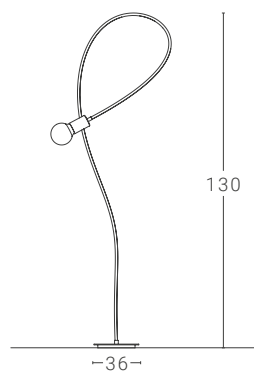

Sorgente luminosa Light source

Attacco E27 (lampadina esclusa)
Max 70W
Lampholder E27 (bulb not included)
Max 70W

Misure indicative.
Indicative dimensions.



Materiale Material

Rame, ottone, ferro
Copper, brass, iron

Finiture Colours

 Rame Copper +  Ottone Brass

Finiture disponibili solo in versione opaca
Finishes available only in matt version

Petit

Design: BMB Progetti



Petit nasce come dice il nome dall'esigenza di creare una lampada che possa rimanere sospesa su di un cavo, regalando la sensazione di equilibrio e leggerezza e un disegno grafico composto da linee che si incrociano. La linee sono infatti il soggetto principale sia per quello che riguarda la fonte luminosa rappresentata da lungo tubolare in alluminio a striscia led, sia per il cavo che la sostiene, anch'esso in tubolare di alluminio con spessore e lunghezza più ridotto. La fonte luminosa che si prolunga per tutta la lunghezza del corpo consente di illuminare ogni punto di una lunga scrivania o di un tavolo regalando una luce perfetta.

Petit was born from the need to create a lamp that can remain suspended on a cable, giving the sensation of balance and lightness and a graphic design composed of intersecting lines. Lines are actually the main subject of the lamp: the light source is a long aluminium tubular led strip and the cable supporting it's also an aluminium tubular with thinner thickness and length. The light source runs the full length of the body and allows every point on a long desk or table to be illuminated with perfect light.

PETIT Plafoniera Ceiling light

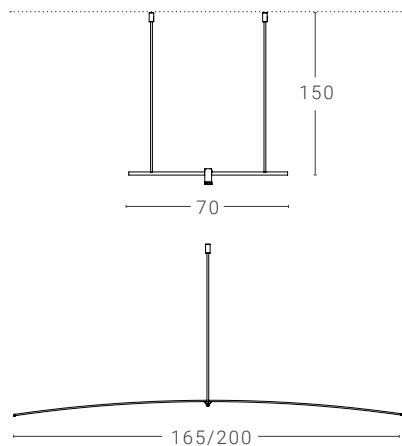

Sorgente luminosa Light source

LED · LED: 32W 2600Lm 3000K (165 cm)
 LED · LED: 40W 3270Lm 3000K (200 cm)
 ON/OFF
 Dimmable

Alimentatore escluso /
 A richiesta disponibile alimentatore da installare remoto in apposita scatola di derivazione impermeabile, non fornita da ZAVA.
 Power supply excluded /
 On request, a power supply unit is available to be installed remotely in a special waterproof junction box, not supplied by ZAVA.

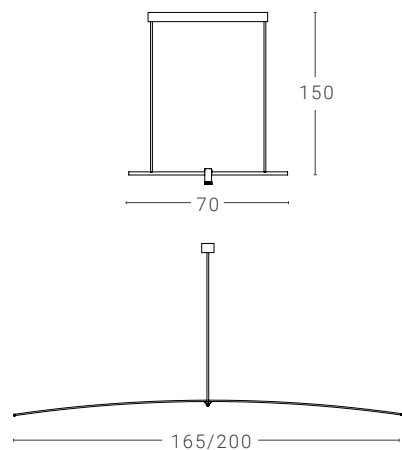

LED · LED: 32W 2600Lm 3000K (165 cm)
 LED · LED: 40W 3270Lm 3000K (200 cm)
 ON/OFF
 Dimmable



Materiale Material

Ferro / Iron

Finiture Colours

- RAL 9010
- Sahara
- Matt silk grey RAL 7044
- RAL 9005
- Verde salvia Sage green

Finiture disponibili solo in versione opaca
 Finishes available only in matt version



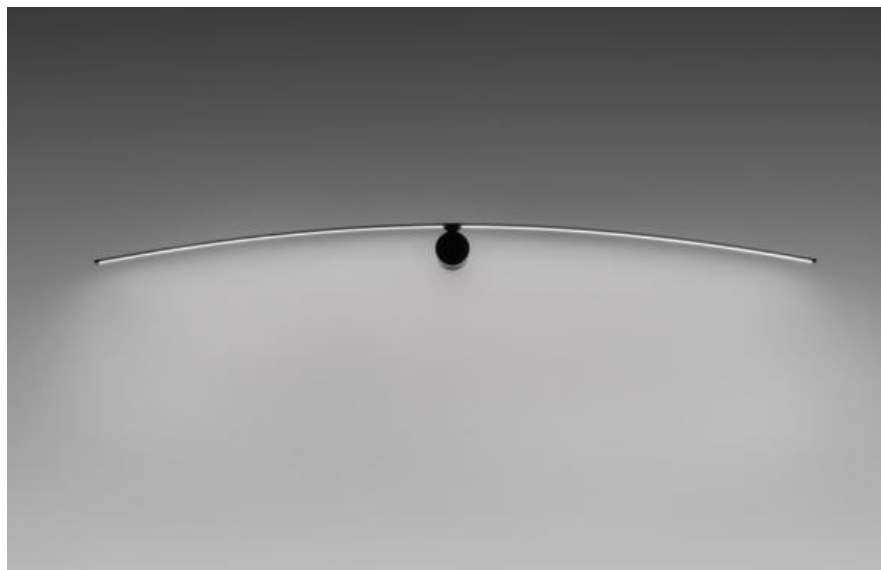

PETIT Parete Wall light

Sorgente luminosa Light source

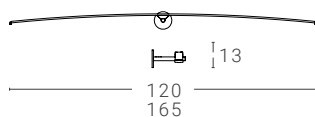

Versione driver remoto
Remote driver version

LED · LED: 32W 2600Lm 3000K (165 cm)
LED · LED: 24W 1800Lm 3000K (120 cm)
ON/OFF
Dimmable

Alimentatore escluso /
A richiesta disponibile alimentatore da installa-
re remoto in apposita scatola di derivazione
impermeabile, non fornita da ZAVA.

Power supply excluded /
On request, a power supply unit is available to
be installed remotely in a special waterproof
junction box, not supplied by ZAVA.

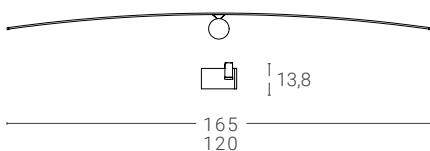

Versione driver a bordo
Driver version on board

LED · LED: 32W 2600Lm 3000K (165 cm)
LED · LED: 24W 1800Lm 3000K (120 cm)
ON/OFF
Dimmable



Materiale Material

Ferro / Iron

Finiture Colours

○ RAL 9010

● Sahara

● Matt silk grey RAL 7044

● RAL 9005

● Verde salvia Sage green

Finiture disponibili solo in versione opaca
Finishes available only in matt version

Pils

Design: Enrico Azzimonti

Un sistema di illuminazione per esterni semplicemente rigoroso ed essenziale dai sentori naturali ed arborei in mimesi con l'ambiente esterno. Pils offre luce su vialetti di casa, nei giardini pubblici e privati, su strade e viali urbani attraverso una armoniosa performance illuminotecnica.

A lighting system for outdoors that is simply austere and minimal with natural and arboreal undercurrents that imitate the external environment. Pils offers lighting for household driveways, public and private gardens, and urban streets and avenues via a harmonious lighting display.

Terra Floor

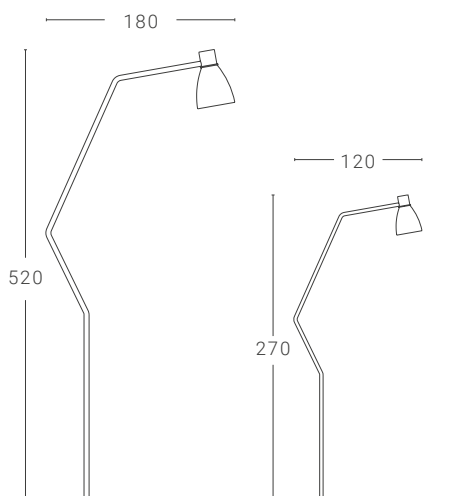

Sorgente luminosa Light source

LED 13W 230V 3000K 1600Lm CRI>80 Energy Class A
LED 26W 230V 3000K 3200Lm CRI>80 Energy Class A

Dimmerabile DALI Energy Class A
DALI Dimmable Energy Class A

Ottica per grande interdistanza tra pali.
Ideale per percorsi pedonali, parchi e strade residenziali
(EN13201 – classe P).

Optics for great interdistance between poles.
Ideal for pedestrian routes, parks and
residential roads (EN13201 - class P).

Cavo PCV nero 10m incluso • PVC cable 10m included

Materiale Material

Ferro
Iron

Finiture Colours

○ RAL 9010

● RAL 9005

Finiture disponibili solo in versione opaca
Finishes available only in matt version



Meridium
Design De Bona.De Meo

Pag. 127



Meta
Design Franco Zavarise

Pag. 131





Meta
Design Franco Zavarise

Pag. 132



Rei
Design Alessandro Zambelli

Pag. 181



Ph21

Design: Franco Zavarise





PH21 Esterno Outdoorlight

Sorgente luminosa Light source

1 x 1,5W G4 LED CERAMIC 12V 2700K
85Lm Energy class A

Alimentatore escluso / A richiesta disponibile
alimentatore da installare remoto in apposita
scatola di derivazione impermeabile, non
fornita da ZAVA.

Power supply excluded / On request, a
power supply unit is available to be installed
remotely in a special waterproof junction box,
not supplied by ZAVA.

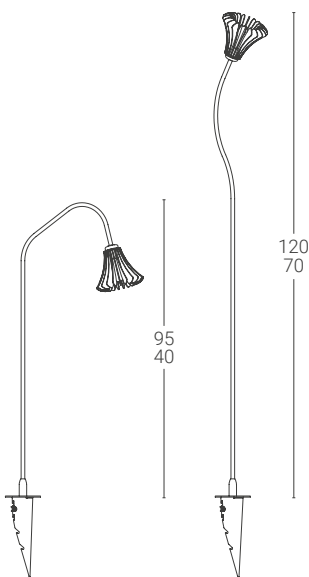

Materiale Material

Alluminio, ottone, rame,
picchetto acciaio inox.
Iron, aluminium, copper,
stainless steel picket.

Petali Petals

- RAL 9010
- Verde rame Copper green

Finiture Colours

- Brunito satinato scuro
Dark satined burnished

Finiture disponibili solo in versione opaca
Finishes available only in matt version

Ragi

Design: Franco Zavarise

Il sistema RAGI è caratterizzato da più cavi coassiali in PVC semi-opaco di colore nero che, partendo dal rosone, alimentano ogni singolo paralume. Gli apparecchi utilizzabili nel sistema RAGI includono sorgenti LED ad alta potenza; il funzionamento è assicurato da un driver di corrente inserito nel rosone. È possibile utilizzare combinazioni di Bull e Mark o, in alternativa, di Nox e Vox in uno stesso sistema Ragi; disponibile nelle versioni radiale e angolare a seconda della posizione del rosone.

The RAGI system is characterized by several coaxial cables in semi-opaque black PVC which, starting from the ceiling rose, feed each individual shade. The devices that can be used in the RAGI system include high-power LED sources; operation is ensured by a current driver inserted in the rose. It is possible to use combinations of Bull and Mark or, alternatively, of Nox and Vox in the same Ragi system; available in radial and angular versions depending on the position of the rose.

Versione Radiale Radial version

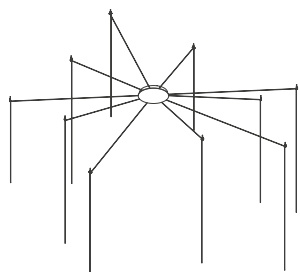

Versione Angolare Angular version

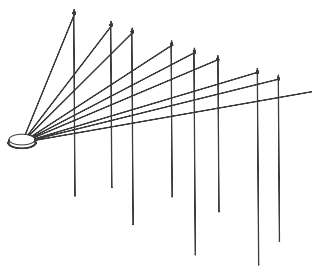

Paralumi disponibili Available lampshades

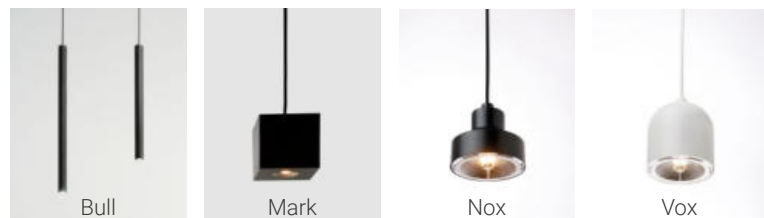

Dettagli: il sistema è componibile e personalizzabile secondo il seguente schema

Details: Modular and customizable system according to the scheme.

Rosone · Ceiling rose



Radiale: fino a 10 luci
Angolare: fino a 6 luci
Radial: up to 10 outputs
Angular: up to 6 outputs

Paralumi · Lampshades

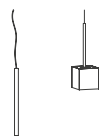

Alimentatori · Power supplies



Supporti · Supports



Supporto per cavo da
fissare al soffitto
Holder for cable for
ceiling fix

Cavi · Cables



Lunghezza max 6m
Max length 6m

Materiale Material

Rosone in ferro o ottone, cavi in PVC
Iron or brass ceiling rose,
PVC cables

Finiture Colours

○ RAL 9010
● RAL 9005

● Ottone Brass

Finiture disponibili solo in versione opaca
Finishes available only in matt version



Ragi T

Design: Franco Zavarise

Il sistema RAGI T supporta paralumi con sorgenti tradizionali o LED funzionanti a tensione di rete, caratterizzati da un portalampade E27 oppure GU10.

Il cavo elettrico che sostiene ogni paralume ha una finitura in tessuto, disponibile in diversi colori. Ad ogni rosone possono essere associati al massimo 15 paralumi.

The RAGI T system supports lampshades with traditional sources or LEDs operating at mains voltage, characterized by an E27 or GU10 lamp holder.

The electric cable that supports each lampshade has a fabric finish, available in different colours. A maximum of 15 lampshades can be associated with each ceiling rose.

Versione Radiale Radial version

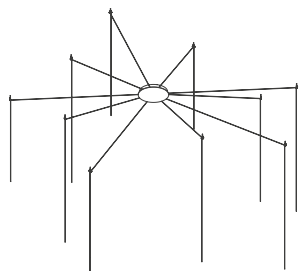

Versione Angolare Angular version

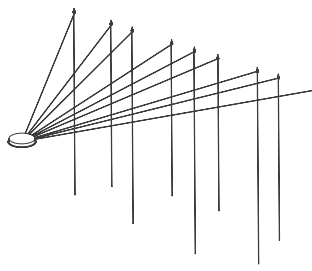

Dettagli: il sistema è componibile e personalizzabile secondo il seguente schema

Details: Modular and customizable system according to the scheme.

Rosone · Ceiling rose



+

Paralumi · Lampshades



+

Supporti · Supports



+

Cavi · Cables



Radiale: fino a 15 luci
Angolare: fino a 15 luci
Radial: up to 15 outputs
Angular: up to 15 outputs

Lista completa alla pagina seguente
Complete list on the next page

Supporto per cavo da
fissare al soffitto
Holder for cable for
ceiling fix

Materiale Material

Rosone in ferro, cavi in tessuto
Iron ceiling rose, textile cables

Finiture Colours



RAL 9010



RAL 9005

Finiture disponibili solo in versione opaca
Finishes available only in matt version





Ragi T

Design: Franco Zavarise

Paralumi disponibili Available lampshades

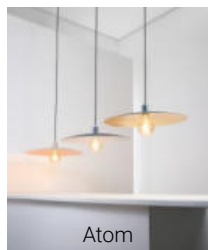

Atom

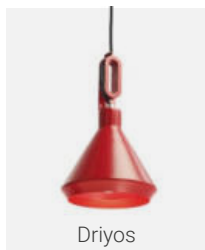

Driyos



Driyos Naked



Jeena



Lady Cage



Nox



Sister



Slices-S



Slices-XL

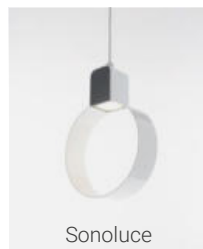

Sonoluce



Vox

Materiale Material

Rosone in ferro, cavi in tessuto
Iron ceiling rose, textile cables

Finiture Colours

○ RAL 9010

● RAL 9005

Finiture disponibili solo in versione opaca
Finishes available only in matt version

Rei

Design: Alessandro Zambelli

Volumi geometrici si intersecano a creare un duplice effetto luminoso. Frontalmente la schermatura del corpo cilindrico rientra a voler svelare il suo interno e disegnare un tenue spicchio di luce. Dal lato opposto, la stessa luce utilizza la parete come schermo riflettente per diffondersi nell'ambiente.

Geometric volumes intersect to create a dual lighting effect. Frontally the shielding of the cylindrical body to draw a faint clove of light. On the opposite side, the same light uses the wall as a reflective screen to spread into the environment.







REI Terra Floor

Sorgente luminosa Light source

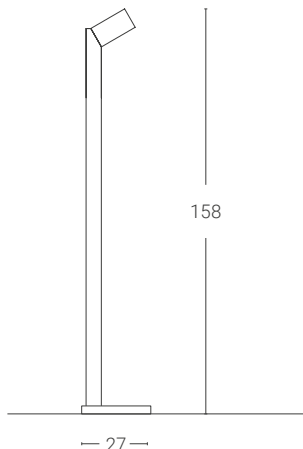

LED 1 x 17W 230V 3000K 2050Lm Energy Class A

Driver ON/OFF incluso / Disponibile driver
dimmerabile DALI/PUSH su richiesta
ON/OFF driver included / DALI/PUSH dimmable
driver available on request.

Su richiesta possibilità di orientare il paralume verso
l'alto o verso il basso.

On request it is possible to orient the lampshade
towards up or down.

REI Tavolo Table

Sorgente luminosa Light source

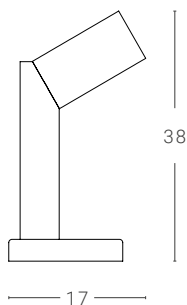

LED 1 x 8W 230V 3000K 1000Lm Energy Class A

Driver ON/OFF incluso / Disponibile driver
dimmerabile DALI/PUSH su richiesta
ON/OFF driver included / DALI/PUSH dimmable
driver available on request

REI Parete Wall light

Sorgente luminosa Light source

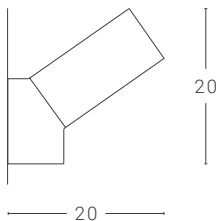

LED 1 x 17W 230V 3000K 2050Lm Energy Class A

Driver ON/OFF incluso / Disponibile driver
dimmerabile DALI/PUSH su richiesta
ON/OFF driver included / DALI/PUSH dimmable
driver available on request

Materiale Material:

Ferro, metacrilato, ottone
Iron, methacrylate, brass

Finiture Colours:

- RAL 9010
- RAL 9005
- Blu oceano Ocean blue

Finiture disponibili solo in versione opaca
Finishes available only in matt version

Rings

Design: Valerio Cometti

Gli anelli di Rings sono disponibili in diversi diametri. Ogni anello è indipendente ed è possibile creare composizioni di qualsiasi forma e dimensione.

Rings structures are available in different diameters. Each ring is independent and it is possible to create compositions of any shape and size.

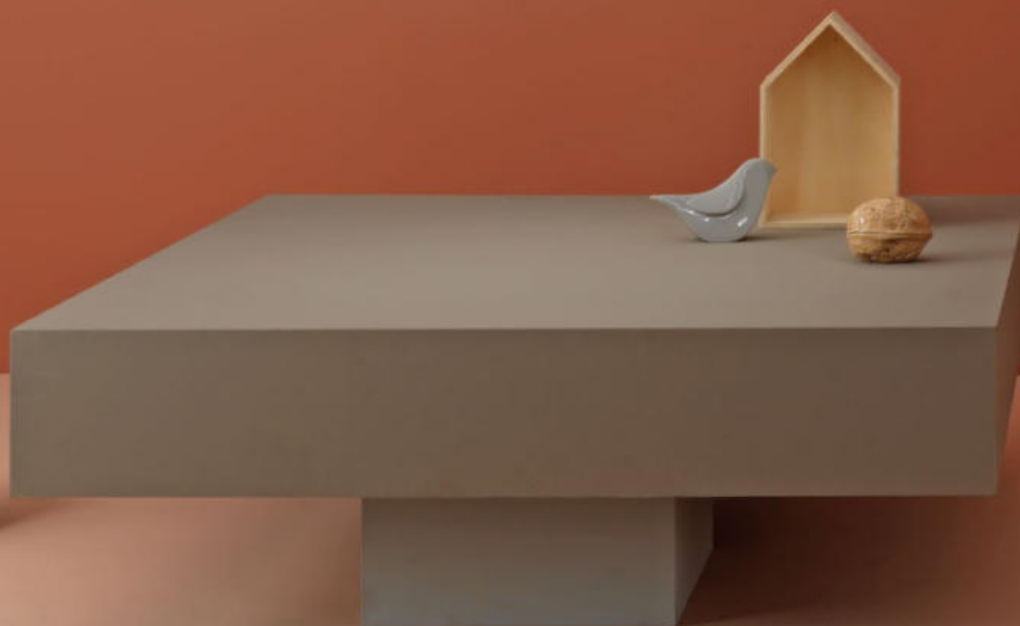



Rings

Design: Valerio Cometti + V12 design

Sospensione orizzontale - Versione A
Horizontal suspension - A version

Sorgente luminosa Light source

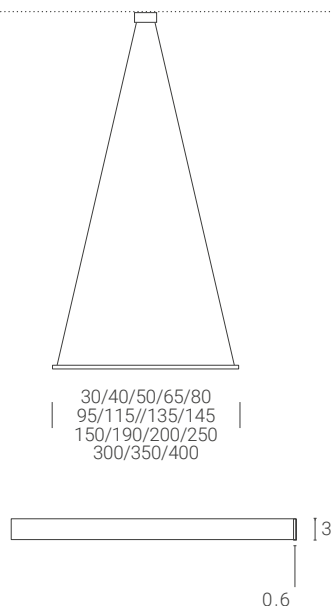

Dimensione rosone per Rings singolo
(a seconda del wattaggio del Rings)
Ceiling rose dimensions of single Rings:
(depending on the wattage of the Rings)
Ø22, Ø30, Ø37 e Ø47 cm

Le dimensioni del rosone nella variante
DALI/PUSH possono essere diverse
The dimensions of the ceiling rose in
DALI /PUSH variant can be different

CRI>94, 240 LED/m
Ø 30 cm: LED 16 W 24V dc 3000K 1224Lm
Ø 40 cm: LED 20 W 24V dc 3000K 1632Lm
Ø 50 cm: LED 25 W 24V dc 3000K 2041Lm
Ø 65 cm: LED 32 W 24V dc 3000K 2653Lm
Ø 80 cm: LED 40 W 24V dc 3000K 3267Lm
Ø 95 cm: LED 48 W 24V dc 3000K 3879Lm
Ø 115 cm: LED 57 W 24V dc 3000K 4694Lm
Ø 135 cm: LED 67 W 24V dc 3000K 5511Lm
Ø 145 cm: LED 72 W 24V dc 3000K 5919Lm
Ø 150 cm: LED 74 W 24V dc 3000K 6123Lm
Ø 190 cm: LED 94 W 24V dc 3000K 7756Lm
Ø 200 cm: LED 99 W 24V dc 3000K 8164Lm
Ø 250 cm: LED 115 W 24V dc 3000K 10205Lm
Ø 300 cm: LED 148 W 24V dc 3000K 12246Lm
Ø 350 cm: LED 177 W 24V dc 3000K 14287Lm
Ø 400 cm: LED 198 W 24V dc 3000K 16328Lm

Alimentatore ON/OFF incluso nel rosone /
Dimmerabile DALI/PUSH su richiesta
ON/OFF power supply included in the ceiling rose /
DALI/PUSH dimmable on request

Sistema modulare componibile e personalizzabile /
Composizioni speciali disponibili su richiesta
Modular customizable system /
Special compositions available on request

A partire dal Ø 250 cm Rings è diviso in due parti.
From Ø 250 cm the Rings is divided into two parts.

Il Rings Ø 400 cm è diviso in 3 parti
The Rings Ø 400 cm is divided into 3 parts

Materiale Material

Alluminio o ottone
Aluminium or brass

Finiture Colours

○ RAL 9010
● RAL 9005
● Verde artico Arctic green
● Ottone Brass

Finiture disponibili solo in versione opaca
Finishes available only in matt version



Rings

Design: Valerio Cometti + V12 design

Sospensione orizzontale - Versione B
Horizontal suspension - B version

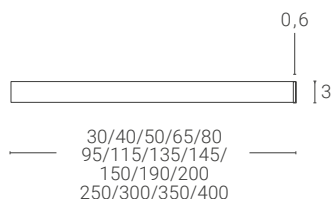
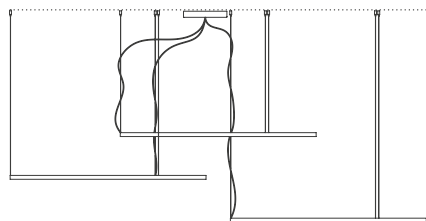

Dimensione rosone per Rings singolo
(a seconda del wattaggio del Rings)
Ceiling rose dimensions of single Rings:
(depending on the wattage of the Rings)
Ø22, Ø30, Ø37 e Ø47 cm

Le dimensioni del rosone nella variante
DALI/PUSH possono essere diverse
The dimensions of the ceiling rose in
DALI /PUSH variant can be different

Sorgente luminosa Light source

CRI>94, 240 LED/m
Ø 30 cm: LED 16 W 24V dc 3000K 1224Lm
Ø 40 cm: LED 20 W 24V dc 3000K 1632Lm
Ø 50 cm: LED 25 W 24V dc 3000K 2041Lm
Ø 65 cm: LED 32 W 24V dc 3000K 2653Lm
Ø 80 cm: LED 40 W 24V dc 3000K 3267Lm
Ø 95 cm: LED 48 W 24V dc 3000K 3879Lm
Ø 115 cm: LED 57 W 24V dc 3000K 4694Lm
Ø 135 cm: LED 67 W 24V dc 3000K 5511Lm
Ø 145 cm: LED 72 W 24V dc 3000K 5919Lm
Ø 150 cm: LED 74 W 24V dc 3000K 6123Lm
Ø 190 cm: LED 94 W 24V dc 3000K 7756Lm
Ø 200 cm: LED 99 W 24V dc 3000K 8164Lm
Ø 250 cm: LED 115 W 24V dc 3000K 10205Lm
Ø 300 cm: LED 148 W 24V dc 3000K 12246Lm
Ø 350 cm: LED 177 W 24V dc 3000K 14287Lm
Ø 400 cm: LED 198 W 24V dc 3000K 16328Lm

Alimentatore ON/OFF incluso nel rosone /
Dimmerabile DALI/PUSH su richiesta
ON/OFF power supply included in the ceiling rose /
DALI/PUSH dimmable on request

Sistema modulare componibile e personalizzabile /
Composizioni speciali disponibili su richiesta
Modular customizable system /
Special compositions available on request

A partire dal Ø 250 cm Rings è diviso in due parti.
From Ø 250 cm the Rings is divided into two parts.

Il Rings Ø 400 cm è diviso in 3 parti
The Rings Ø 400 cm is divided into 3 parts

Materiale Material

Alluminio o ottone
Aluminium or brass

Finiture Colours



RAL 9010



Verde artico Arctic green



RAL 9005



Ottone Brass

Finiture disponibili solo in versione opaca
Finishes available only in matt version



Rings

Design: Valerio Cometti + V12 design

Sospensione verticale Vertical suspension

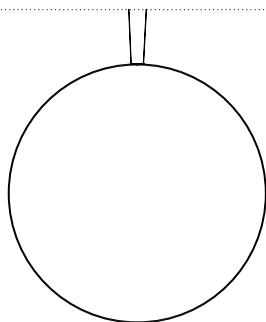

30/40/50/65/80/95/115/
135/ 145/150/190

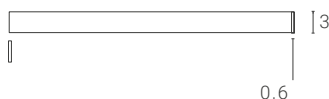

Dimensione rosone per Rings singolo
(a seconda del wattaggio del Rings)
Ceiling rose dimensions of single Rings:
(depending on the wattage of the Rings)

7,5x20x3,8
7,5x23,5x3,8
7,5x25,5x3,8
9,5x28x3,8
12x3,8x5

Le dimensioni del rosone nella variante
DALI/PUSH possono essere diverse
The dimensions of the ceiling rose in
DALI /PUSH variant can be different

Sorgente luminosa Light source

CRI>94, 240 LED/m

Ø 30 cm: LED 16 W 24V dc 3000K 1224Lm
Ø 40 cm: LED 20 W 24V dc 3000K 1632Lm
Ø 50 cm: LED 25 W 24V dc 3000K 2041Lm
Ø 65 cm: LED 32 W 24V dc 3000K 2653Lm
Ø 80 cm: LED 40 W 24V dc 3000K 3267Lm
Ø 95 cm: LED 48 W 24V dc 3000K 3879Lm
Ø 115 cm: LED 57 W 24V dc 3000K 4694Lm
Ø 135 cm: LED 67 W 24V dc 3000K 5511Lm
Ø 145 cm: LED 72 W 24V dc 3000K 5919Lm
Ø 150 cm: LED 74 W 24V dc 3000K 6123Lm
Ø 190 cm: LED 94 W 24V dc 3000K 7756Lm

Alimentatore ON/OFF incluso nel rosone /
Dimmerabile DALI/PUSH su richiesta
ON/OFF power supply included in the ceiling rose /
DALI/PUSH dimmable on request

Sistema modulare componibile e personalizzabile /
Composizioni speciali disponibili su richiesta
Modular customizable system /
Special compositions available on request

Materiale Material

Alluminio o ottone
Aluminium or brass

Finiture Colours

○ RAL 9010
● RAL 9005
● Verde artico Arctic green
● Ottone Brass

Finiture disponibili solo in versione opaca
Finishes available only in matt version





Rings

Design: Valerio Cometti + V12 design

Parete e plafoniera
Wall and ceiling light

Sorgente luminosa Light source

30/40/50/65/80/95
115/135/145/150/190
200/250/300/350/400

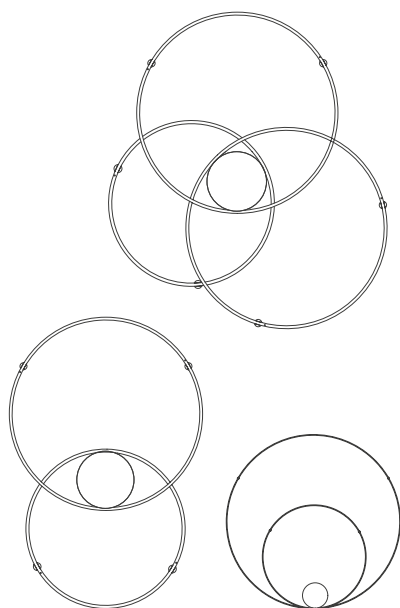

Dimensione rosone per Rings singolo
(Singolo, doppio o triplo a seconda del
wattaggio del Rings o della composizione)
Ceiling rose dimensions of single Rings:
(Single, double or triple depending on
wattage of the Rings or composition)
Ø12,5, Ø14,5, Ø20, Ø22, Ø33 cm

Le dimensioni del rosone nella variante
DALI/PUSH possono essere diverse
The dimensions of the ceiling rose/rosette
in DALI /PUSH variant can be different

CRI>94, 240 LED/m

Ø 30 cm: LED 16 W 24V dc 3000K 1224Lm
Ø 40 cm: LED 20 W 24V dc 3000K 1632Lm
Ø 50 cm: LED 25 W 24V dc 3000K 2041Lm
Ø 65 cm: LED 32 W 24V dc 3000K 2653Lm
Ø 80 cm: LED 40 W 24V dc 3000K 3267Lm
Ø 95 cm: LED 48 W 24V dc 3000K 3879Lm
Ø 115 cm: LED 57 W 24V dc 3000K 4694Lm
Ø 135 cm: LED 67 W 24V dc 3000K 5511Lm
Ø 145 cm: LED 72 W 24V dc 3000K 5919Lm
Ø 150 cm: LED 74 W 24V dc 3000K 6123Lm
Ø 190 cm: LED 94 W 24V dc 3000K 7756Lm
Ø 200 cm: LED 99 W 24V dc 3000K 8164Lm
Ø 250 cm: LED 115 W 24V dc 3000K 10205Lm
Ø 300 cm: LED 148 W 24V dc 3000K 12246Lm
Ø 350 cm: LED 177 W 24V dc 3000K 14287Lm
Ø 400 cm: LED 198 W 24V dc 3000K 16328Lm

Alimentatore ON/OFF incluso nel rosone /
Dimmerabile DALI/PUSH su richiesta
ON/OFF power supply included in the ceiling rose /
DALI/PUSH dimmable on request

Sistema modulare componibile e personalizzabile /
Composizioni speciali disponibili su richiesta
Modular customizable system /
Special compositions available on request

A partire dal Ø 250 cm Rings è diviso in due parti.
From Ø 250 cm the Rings is divided into two parts.

Il Rings Ø 400 cm è diviso in 3 parti
The Rings Ø 400 cm is divided into 3 parts

Materiale Material

Alluminio o ottone
Aluminium or brass

Finiture Colours

○ RAL 9010

● RAL 9005

● Verde artico Arctic green

● Ottone Brass

Finiture disponibili solo in versione opaca
Finishes available only in matt version

Ronin

Design: Testatonda

Nasce così la collezione Ronin per Zava che si compone di una piantana, una lampada a sospensione e un'applique. Il motivo plissettato del cappello è il segno stilistico della collezione. Presentata in tre diverse dimensioni le lampade sono prodotte in ferro verniciato.

Thus was born the Ronin collection for Zava, consisting of a floor lamp, a pendant lamp, and a wall lamp. The pleated motif on the lampshade is the stylistic hallmark of the collection. Presented in three different sizes, the lamps are made of painted iron.





RONIN Terra Floor

Sorgente luminosa Light source

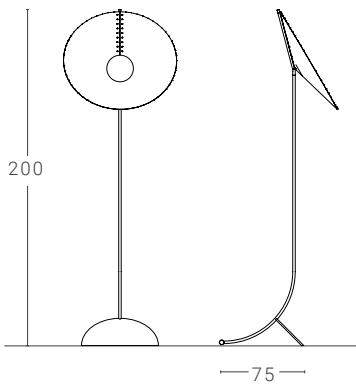

LED · LED: 17W 2300Lm 3000K
ON/OFF
Dimmable

Materiale Material

Ferro, alluminio o ottone
Iron, aluminium or brass

Finiture Colours

- RAL 9010
- RAL 9005
- Verde salvia
Sage green
- Sahara
- Matt silk grey
RAL 7044
- Blu oceano
Ocean blue

Cavo Cable

Colore a scelta (vedi tabella colori).
Colour on demand
(see cables colour chart).

Finiture disponibili solo in versione opaca
Finishes available only in matt version





RONIN Parete Wall light

Sorgente luminosa Light source

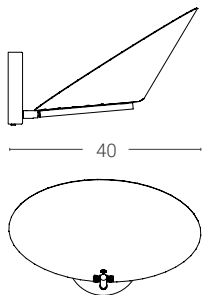

LED · LED: 17W 2300Lm 3000K
ON/OFF
Dimmable



Materiale Material

Ferro, alluminio o ottone
Iron, aluminium or brass

Finiture Colours

○ RAL 9010

● Sahara

● Matt silk grey RAL 7044

● RAL 9005

● Verde salvia Sage green

● Blu oceano Ocean blue

Finiture disponibili solo in versione opaca
Finishes available only in matt version



RONIN Sospensione Suspension

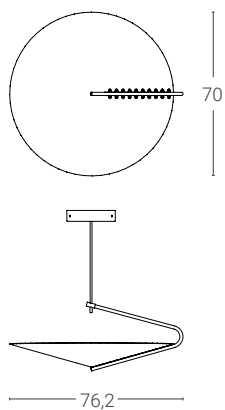

Materiale Material

Ferro, alluminio o ottone
Iron, aluminium or brass

Sorgente luminosa Light source

LED · LED: 17W 2300Lm 3000K
ON/OFF
Dimmable

Finiture Colours

○ RAL 9010

● Sahara

● Matt silk grey RAL 7044

● RAL 9005

● Verde salvia Sage green

Finiture disponibili solo in versione opaca
Finishes available only in matt version

Salvia

Design: BMB Progetti

Salvia è una lampada da giardino per l'illuminazione di vialetti e fioriere. L'idea è quella di avere una lampada leggera e sobria che richiamasse le linee semplici di un ramo e di una foglia, che durante il giorno si fonde e si confonde tra vialetti e fioriere.

Sage is a garden lamp for illuminating pathways and flower beds. The idea was to have a lamp light and sober that recalls the simple lines of a branch and a leaf, which blends into the landscape.



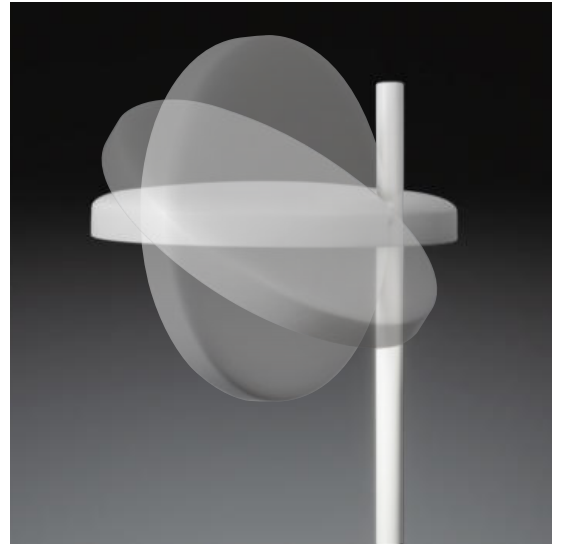

SALVIA Esterno Outdoor

Sorgente luminosa Light source

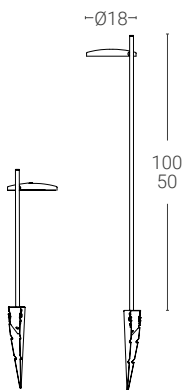

LED · LED: 2,9W 532Lm 3000K
ON/OFF
IP65

Alimentatore escluso /
A richiesta disponibile alimentatore da installare
remoto in apposita scatola di derivazione
impermeabile, non fornita da ZAVA.
Power supply excluded /
On request, a power supply unit is available to be
installed remotely in a special waterproof junction
box, not supplied by ZAVA.

Materiale Material

Alluminio, acciaio inox
Aluminum, stainless steel

Finiture Colours

○ RAL 9010

● Sahara

● Matt silk grey RAL 7044

● RAL 9005

● Verde salvia Sage green

Finiture disponibili solo in versione opaca
Finishes available only in matt version



San Babila

Design: Meneghello & Paoletti





SAN BABILA Parete Wall light

Sorgente luminosa Light source

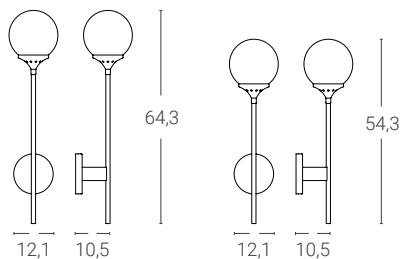

Attacco E14 (lampadina esclusa)
 Max 42W
 Lampholder E14 (bulb not included)
 Max 42W

SAN BABILA Parete Wall light

Sorgente luminosa Light source

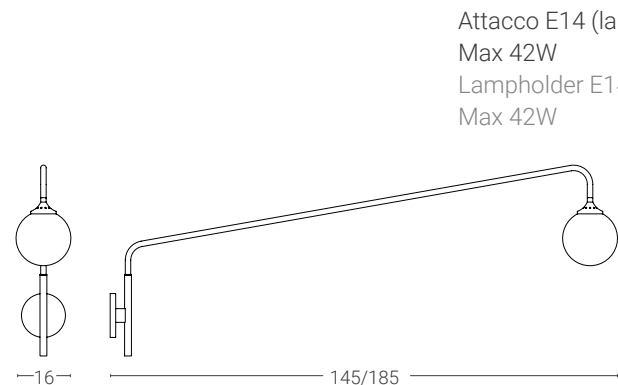

Attacco E14 (lampadina esclusa)
 Max 42W
 Lampholder E14 (bulb not included)
 Max 42W

SAN BABILA Parete Wall light

Sorgente luminosa Light source

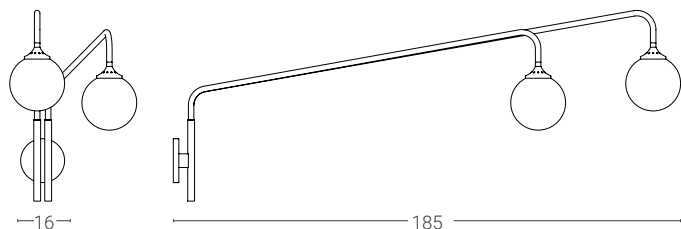

Attacco E14 (lampadina esclusa)
 Max 42W
 Lampholder E14 (bulb not included)
 Max 42W

Materiale Material

Ferro, vetro
 Iron, glass

Finiture Colours

- RAL 9010
- Sahara
- Matt silk grey RAL 7044
- RAL 9005
- Verde salvia Sage green

Finiture disponibili solo in versione opaca
 Finishes available only in matt version

Sister

Design: Enrico Azzimonti

Una lampada materica e armoniosa ma nello stesso tempo definita, con un elemento che ricorda l'arte industriale, dal carattere moderno e deciso. Il prodotto si presta per ambienti raffinati ed eleganti e dona un tocco personale a qualsiasi arredamento.

An harmonious lighting object and at the same time with a modern and decisive mood that reminds the industrial art. The product lends itself to refined and elegant environments and gives a personal touch to any furnishings.





SISTER Sospensione Suspension

Sorgente luminosa Light source

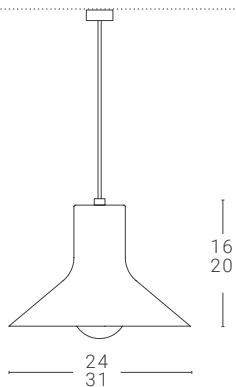

Attacco GU10 (lampadina esclusa)
{A → E} Max 15W
Lampholder (bulb not included) GU10
{A → E} Max 15W

Attacco E27 (lampadina esclusa)
Max 70W
Lampholder E27 (bulb not included)
Max 70W



Dim. rosone: Ø 11,5 cm altezza 4 cm
Ceiling rose dim.: Ø 11,5 cm height 4 cm

SISTER Terra Floor

Sorgente luminosa Light source

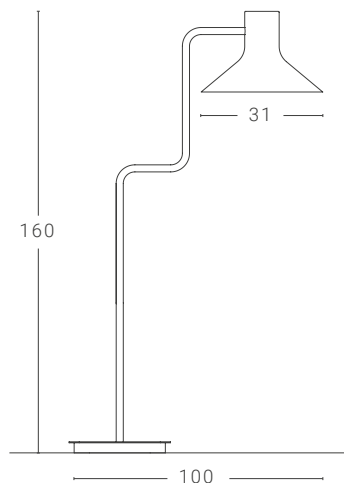

Attacco GU10 (lampadina esclusa)
{A → E} Max 15W
Lampholder GU10 (bulb not included)
{A → E} Max 15W

Attacco E27 (lampadina esclusa)
Max 70W
Lampholder E27 (bulb not included)
Max 70W

Lampada orientabile sulla base, sullo stelo
e sulla cupola.
Orientable fitting on the base, on the tube
and on the shade.



SISTER Parete Wall light

Sorgente luminosa Light source

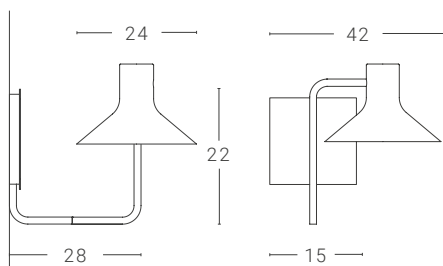

Attacco GU10 (lampadina esclusa) {A → E}
Max 15W
Lampholder GU10 (bulb not included) {A → E}
Max 15W

Attacco E14 (lampadina esclusa)
Max 42W
Lampholder E14 (bulb not included)
Max 42W

Lampada orientabile sulla base, sullo stelo
e sulla cupola. / Orientable fitting on the base,
on the tube and on the shade.





SISTER Tavolo Table

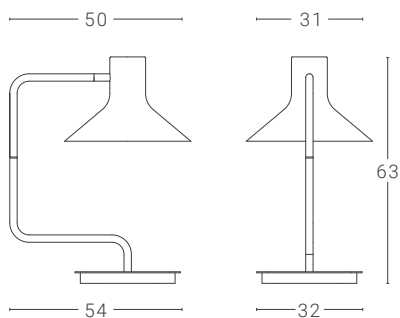

Sorgente luminosa Light source

Attacco GU10 (lampadina esclusa) {A -> E}
Max 15W
Lampholder GU10 (bulb not included) {A -> E}
Max 15W

Attacco E27 (lampadina esclusa)
Max 70W
Lampholder E27 (bulb not included)
Max 70W

Lampada orientabile sulla base, sullo stelo e sulla cupola. / Orientable fitting on the base, on the tube and on the shade.



SISTER Lumetto Table

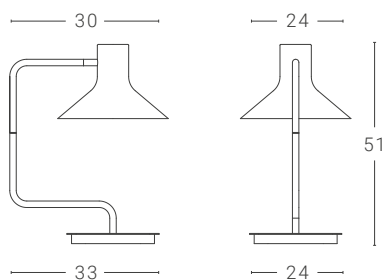

Sorgente luminosa Light source

Attacco GU10 (lampadina esclusa) {A -> E}
Max 15W
Lampholder GU10 (bulb not included) {A -> E}
Max 15W

Attacco E14 (lampadina esclusa)
Max 42W
Lampholder E14 (bulb not included)
Max 42W

Lampada orientabile sulla base, sullo stelo e sulla cupola. / Orientable fitting on the base, on the tube and on the shade.



Materiale Material

Ferro
Iron

Finiture Colours

Combinazione di colori a scelta, alternati al bianco di base, per i modelli che prevedono lo snodo.
Combination of colors of your choice, alternating with the basic white, for models that have a junction.

○ RAL 9010

● RAL 9005

● RAL 3002

Finiture disponibili solo in versione opaca
Finishes available only in matt version

Monocolore Monochrome

● Blu di laminazione
Iron blu
● Ruggine naturale
Natural rust

Sketch

Design: Enrico Azzimonti

"Ho sempre pensato che l'oggetto lampada prenda forma dalla fonte luminosa attraverso un pensiero progettuale volto alla risoluzione di bisogni... Sul foglio si schizza la lampadina, si aggiunge un piano di appoggio, magari un archivio per libri o musica e, perché no, infiniti profili di lampade che avvolgono la luce..." Disponibile anche versione con superficie scrivibile con pennarelli per lavagna bianca.

Su richiesta luce di lettura con tubo flessibile in ottone cromato L500mm con sorgente LED.

"I always thought that the lighting object takes shape from the light source, through a design concept aimed at the resolution of needs... on the sheet the bulb is sketched, a ground plane is added, maybe a repository for books or music, and why not, infinite profiles of lamps which envelop the light..." Available also with writeable surface with markers for the whiteboard. On request flexible chrome-plated brass reading light L500mm with light source LED.

Parete Wall light

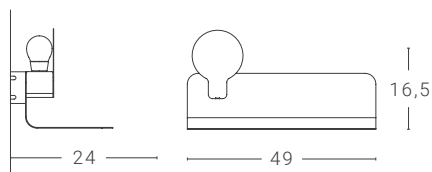

Sorgente luminosa Light source

Attacco E27 (lampadina esclusa) Max 70W
Lampholder E27 (bulb not included) Max 70W

Materiale Material

Ferro
Iron

Finiture Colours

- RAL 9010
- RAL 9005

Finiture disponibili solo in versione opaca
Finishes available only in matt version

Cavo Cable

- Rayon nero Black rayon



Slices-S

Design: Mariam Aivazyan

Una lampada a sospensione in metallo, utilizzabile anche come lampada da tavolo e da terra: pratica, utilizzabile in qualsiasi stanza della casa così come in hotel e ristoranti. Attira l'attenzione cambiando il suo aspetto a seconda dei punti di vista grazie alla geometria asimmetrica.

A pendant lamp made of metal, can be used as table or floor lamp: practical, for use in any room of the house as well as for hotel and restaurant interiors. Thanks to its asymmetrical geometry, it draws attention, changing its appearance according to personal perspective.







SLICES-S Sospensione Suspension

Sorgente luminosa Light source

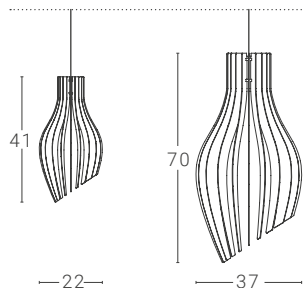

Attacco E27 (lampadina esclusa)
Max 70W
Lampholder E27 (bulb not included)
Max 70W

Dim. rosone piccolo: Ø 5,5 cm altezza 6 cm
Small ceiling rose dim.: Ø 5,5 cm height 6 cm
Dim. rosone grande: Ø 8,5 cm altezza 8 cm
Big ceiling rose dim.: Ø 8,5 cm height 8 cm

SLICES-S Terra Floor

Sorgente luminosa Light source

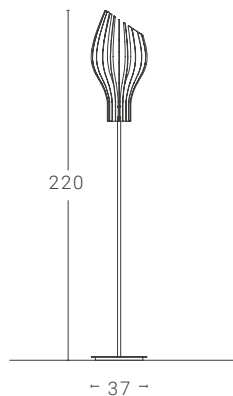

Attacco E27 (lampadina esclusa)
Max 70W
Lampholder E27 (bulb not included)
Max 70W

SLICES-S Tavolo Table

Sorgente luminosa Light source

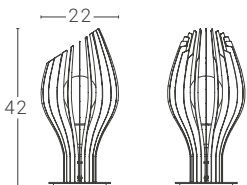

Attacco E27 (lampadina esclusa)
Max 70W
Lampholder E27 (bulb not included)
Max 70W

Materiale Material

Ferro, alluminio o ottone
Iron, aluminium or brass

Finiture Colours

- RAL 9010
- RAL 9005
- Ottone Brass

Finiture disponibili solo in versione opaca
Finishes available only in matt version

Cavo pvc Pvc cable

- Trasparente Transparent

Slices-XL

Design: Mariam Ayvazyan

Una lampada a sospensione in metallo pratica, utilizzabile in qualsiasi stanza della casa così come in hotel e ristoranti. Attira l'attenzione cambiando il suo aspetto a seconda dei punti di vista grazie alla geometria asimmetrica.

A pendant lamp made of metal for use in any room of the house as well as for hotel and restaurant interiors. Thanks to its asymmetrical geometry, it draws attention, changing its appearance according to personal perspective.

Sospensione grande Big suspension



Dim. rosone: Ø 8,5 cm altezza 8 cm
Ceiling rose dim.: Ø 8,5 cm height 8 cm

Sorgente luminosa Light source

Attacco E27 (lampadina esclusa)
Max 70W
Lampholder E27 (bulb not included)
Max 70W

Sospensione piccola Small suspension



Dim. rosone: Ø 5,5 cm altezza 6 cm
Ceiling rose dim.: Ø 5,5 cm height 6 cm

Sorgente luminosa Light source

Attacco E27 (lampadina esclusa)
Max 70W
Lampholder E27 (bulb not included)
Max 70W

Materiale Material

Ferro, alluminio o ottone
Iron, aluminium or brass

Finiture Colours

- RAL 9010
- RAL 9005
- Ottone Brass

Finiture disponibili solo in versione opaca
Finishes available only in matt version

Cavo Cable

- Rayon nero Black rayon



Soda

Design: Franco Zavarise

"Quando ho disegnato questa lampada è stato il primo nome che mi è venuto in mente perché ho pensato alla sua forma compatta e massiccia." Soda si ispira alle vecchie lampade industriali ma si ingentilisce con il suo interno colorato a contrasto o in foglia oro, argento o rame.

"When I designed this lamp was the first name that came into my mind because I thought to its compact and massive shape." Soda is inspired by the old industrial lamps but becomes more gentle thanks to the colorful interior or decorated with gold, silver or copper leaf finish.

Parete Wall light

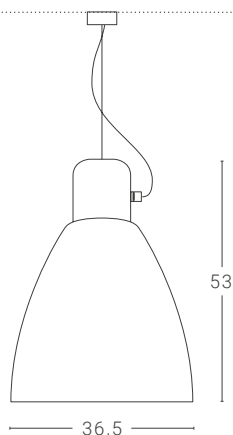

Sorgente luminosa Light source

Attacco E27 (lampadina esclusa) Max 70W
Lampholder E27 (bulb not included) Max 70W

LED 1 x 26W 230V 3000/4000K 3060Lm Energy Class A
Driver ON/OFF incluso /
Disponibile driver dimmerabile DALI/PUSH su richiesta
ON/OFF driver included /
DALI/PUSH dimmable driver available on request

Dim. rosone: Ø 10 cm altezza 6 cm
Ceiling rose dim.: Ø 10 cm height 6 cm

Le dimensioni del rosone nella variante DALI/PUSH possono essere diverse
The dimensions of the ceiling rose in DALI /PUSH variant can be different

Materiale Material

Ferro
Iron

Finiture esterne Outside colours

- RAL 9010
- RAL 9005
- Blu di laminazione Iron blu

Finiture disponibili solo in versione opaca
Finishes available only in matt version

Finiture interne Inside colours

Personalizzabile su richiesta
(vedi lista colori fine catalogo) o foglia oro / argento / rame
Customizable on demand (see colours list of at the end of catalogue) or golden / silver / copper leaf

Cavo PVC PVC Cable

- Nero Black



Sonoluce

Design: Andrea Brugnera

Sonoluce nasce dalla volontà di custodire e confinare la luce all'interno di un sottile cerchio, sfruttando la sua stessa riflessione. Un'appendice colorata contiene la fonte luminosa. Con la sua forma minimale, Sonoluce è adatta ad essere appoggiata su un piano, agganciata alla parete oppure può scendere sospesa dal soffitto. Realizzata con una sottile lamiera è disponibile nei vari colori Zava con il cerchio bianco.

Sonoluce has originated from the desire to preserve and confine the light within a fine circle, thus exploiting its own reflection. A colourful attachment contains the light source. With its minimal form, Sonoluce can be adapted so that is either floor-standing, wall-attached or suspended from the ceiling. Made from fine sheet metal it is available in various Zava colours combined with the white circle.







SONOLUCE Sospensione Suspension

Sorgente luminosa Light source

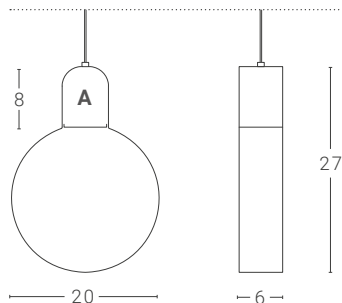

Attacco GU10 Max 15W /
Lampholder GU10 Max 15W
Lampadina LED a tensione di rete /
LED mains voltage bulb
1 x 8W 230V 2700K/4000K 600Lm/700Lm Energy Class A
Non dimmerabile / No Dimmable

Dim. rosone: Ø 4,5 cm altezza 7 cm
Ceiling rose dim.: Ø 4,5 cm height 7 cm

SONOLUCE Tavolo Table

Sorgente luminosa Light source

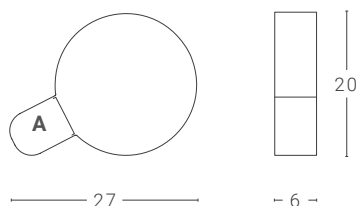

Attacco GU10 Max 15W /
Lampholder GU10 Max 15W
Lampadina LED a tensione di rete /
LED mains voltage bulb
1 x 8W 230V 2700K/4000K 600Lm/700Lm Energy Class A
Non dimmerabile / No Dimmable

SONOLUCE Parete Wall light

Sorgente luminosa Light source

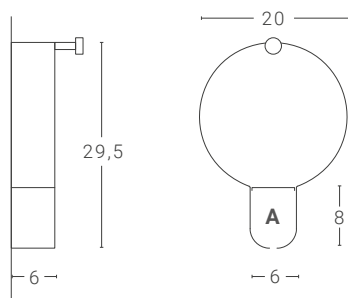









Attacco GU10 Max 15W /
Lampholder GU10 Max 15W
Lampadina LED a tensione di rete /
LED mains voltage bulb
1 x 8W 230V 2700K/4000K 600Lm/700Lm Energy Class A
Non dimmerabile / No Dimmable

Materiale Material

Ferro
Iron

Finiture dettaglio interno (A) Indoor detail colours (A)

Finiture dettaglio esterno Outside detail colours

- | | |
|--|---|
|  RAL 9010 |  RAL 6034 |
|  RAL 9005 |  Verde giungla
Jungle green |
|  RAL 3002 |  Blu oceano
Ocean blue |
|  RAL 1003 |  Verde salvia
Sage green |

-  RAL 9010

Finiture disponibili solo in versione opaca
Finishes available only in matt version

Cavo Cable  Rayon bianco White rayon

Vox

Design: Franco Zavarise

Si chiama Vox questa lampada a sospensione dalle dimensioni ridotte, perfetta per essere composta in grappoli grazie ai sistemi Ragi, Ragi-T e ZERO2.

Named Vox, this is pendant lamp with reduced dimensions, perfect in cluster arrangements thanks to Ragi, Ragi-T and ZERO2 systems.

Sospensione Suspension

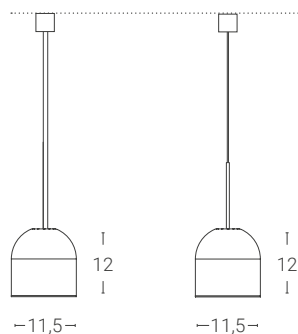

Dim. rosone: Ø 5,5 cm altezza 6 cm
Ceiling rose dim.: Ø 5,5 cm height 6 cm

Le dimensioni del rosone nella variante DALI/PUSH possono essere diverse
The dimensions of the ceiling rose in DALI /PUSH variant can be different

Sorgente luminosa Light source

Attacco GU10 Max 15W /
Lampholder GU10 Max 15W
Lampadina LED a tensione di rete /
LED mains voltage bulb
1 x 13W 230V 2700K 880Lm/950Lm
Energy Class A
Dimmerabile a taglio di fase solo con regolatori selezionati non forniti da ZAVA.
Phase-cut dimmable only with selected controllers not supplied by ZAVA.



LED 1 x 25W 230V 3000K 2450Lm CRI>90
Energy Class A
Driver ON/OFF incluso / Disponibile driver dimmerabile DALI/PUSH su richiesta
ON/OFF driver included / DALI/PUSH dimmable driver available on request



Materiale Material

Ferro
Iron

Finiture Colours

-  RAL 9010
-  RAL 9005
-  Ottone Brass

Finiture disponibili solo in versione opaca
Finishes available only in matt version

Cavo Cable

Colore a scelta (vedi tabella colori).
Versione GU10 cavo rayon nero
Colour on demand
(see cables colour chart).
GU10 version black rayon cable

Versione LED: cavo in PVC
LED version: PVC cable



Wa

Design: Alessandro Zambelli

Dalla traduzione letterale Giapponese "armonia, pace, equilibrio". Linee rigorose e semplici. Giochi di incastri dove ogni elemento è pensato partendo dalla propria funzione. Nulla è più di ciò che è necessario.

From the literal Japanese translation "harmony, peace, balance". Rigorous and simple lines. Interlocking games where each element is designed starting from its own function. Nothing is more than what is needed.

Terra Floor

Sorgente luminosa Light source

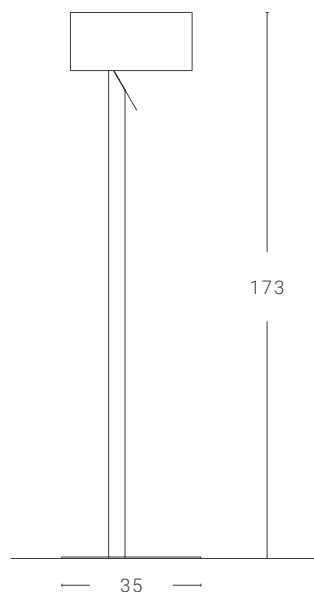

Luce indiretta / Indirect light:
LED 1 x 9W 230V 3000K 1200Lm Energy Class A
+
Luce diretta / Direct light:
LED 1 x 6,5W 230V 3000K 800Lm Energy Class A

Piantana a luce diretta/indiretta dimmerabile
mediante sensore touch /
Direct/indirect light floor lamp dimmable
via touch sensor

Attacco 3 x E27 (lampadina esclusa)
Max 70W
Lampholder 3 x E27 (bulb not included)
Max 70W

Materiale Material

Ferro, alluminio, metacrilato, ottone
Iron, aluminium, methacrylate, brass

Finiture Colours

○ RAL 9010
● RAL 9005

● Blu oceano Ocean blue
● Verde giungla Jungle green

Finiture disponibili solo in versione opaca
Finishes available only in matt version



ZERO2

Design: Franco Zavarise

Caratterizzato da un unico cavo coassiale in PVC semi-opaco nero che compone una linea continua tra le varie sorgenti di luce, può essere composto con quattro paralumi: Bull, Mark, Nox e Vox. È possibile utilizzare combinazioni di Bull e Mark o, in alternativa, di Nox e Vox in uno stesso sistema con un unico cavo coassiale. Ogni rosone permette di montare al massimo 10 corpi illuminanti per Bull e Mark, 3 per Nox e Vox e massimo 30 metri lineari di cavo coassiale. In caso di composizioni miste, sarà necessario utilizzare più rosone.

Characterised by a single coaxial semi-opaque black PVC cable that makes up a continuous line between the various light sources, it can be composed by four different lampshades: Bull, Mark, Nox and Vox. It is possible to use combinations of Bull and Mark or, alternatively, of Nox and Vox in the same ZERO2 system, with a single coaxial cable. Each ceiling rose allows to mount at most 10 lighting fixtures for Bull and Mark, 3 for Nox and Vox and maximum 30 linear meters of coaxial cable. While mixing compositions, it would be necessary to use more canopies.

Paralumi disponibili Available lampshades

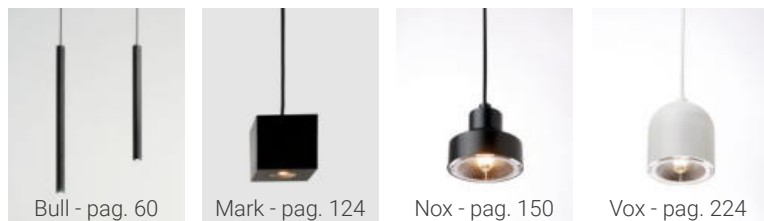

Bull - pag. 60

Mark - pag. 124

Nox - pag. 150

Vox - pag. 224

Esempi di sistema preallestiti Examples of pre-fitted systems

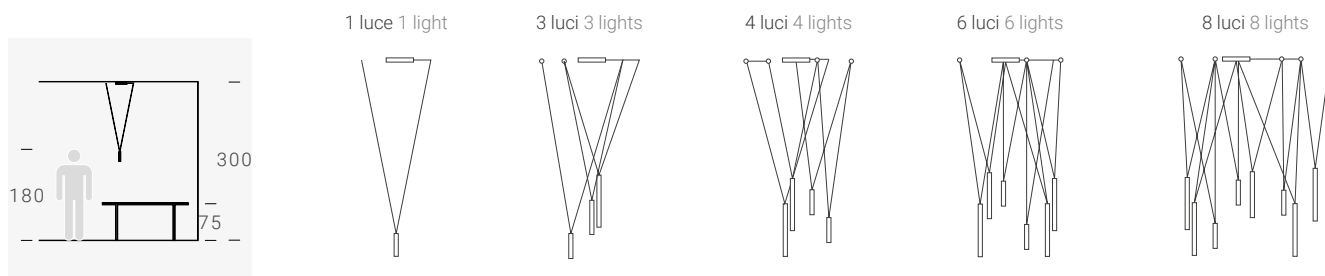

Dettagli: il sistema è componibile e personalizzabile secondo il seguente schema

Details: Modular and customizable system according to the scheme.

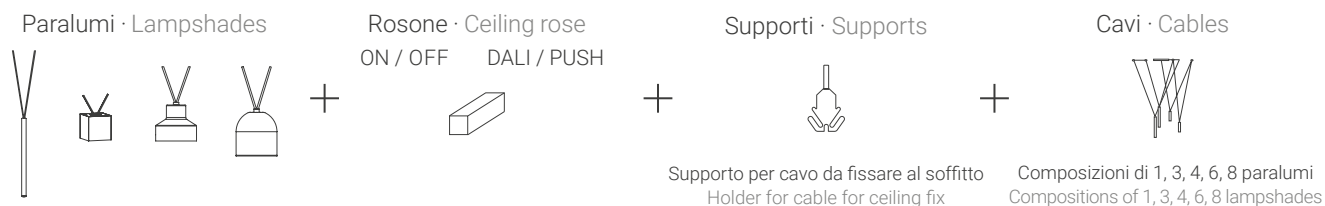

Materiale Material

Rosone in ferro, cavi in PVC
Iron ceiling rose, PVC cables

Finiture Colours

- RAL 9010
- RAL 9005
- Ottone Brass

Finiture disponibili solo in versione opaca
Finishes available only in matt version

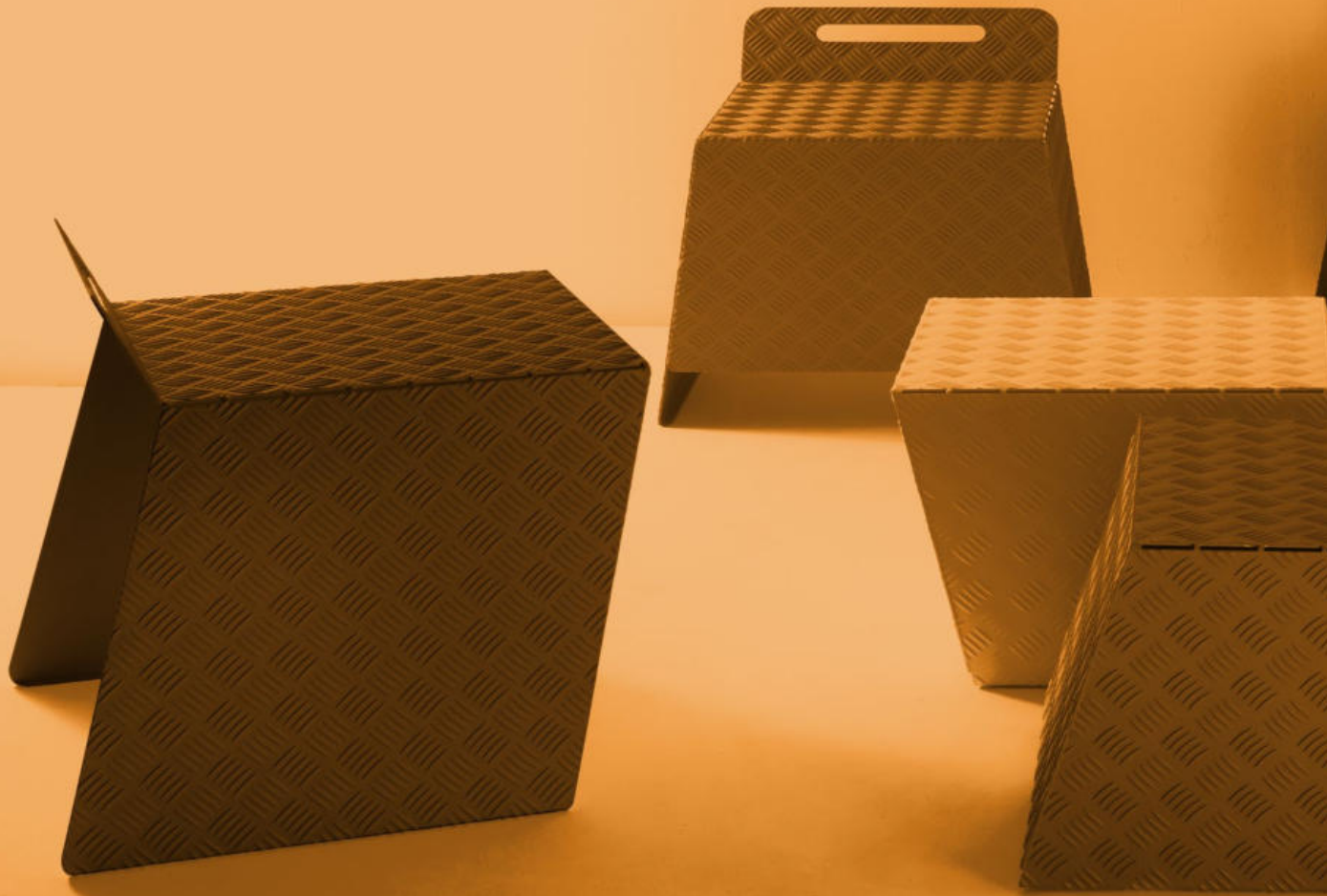

Complementi

Complements



349

Design: Franco Zavarise

Libreria a muro "snodata", modulare e componibile, realizzata in metallo verniciato.

Wall-mounted modular bookshelf, created in metal painted.

Complemento Complement

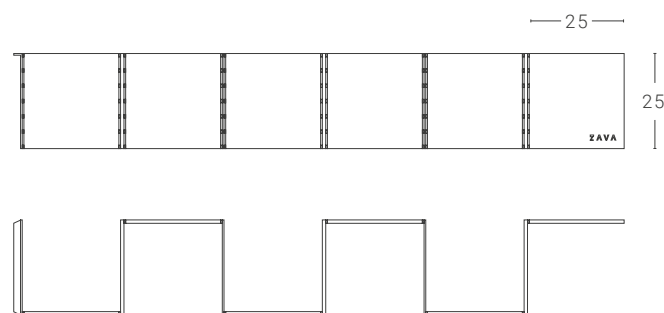

Disponibile in confezioni da 5 moduli.
Available in packs of 5 modules.

Materiale Material

Ferro
Iron

Finiture Colours

- RAL 9010
- RAL 9005
- RAL 3004

- Ruggine naturale Natural rust
- Blu di laminazione Iron blu

Finiture disponibili solo in versione opaca
Finishes available only in matt version



Concrete

Design: Enrico Azzimonti

"Ci si aspetta che una libreria sia solida come il cemento, sia realmente in grado di adattarsi alle necessità di archiviazione, sia flessibile, aggregabile, interpretabile nel tempo così da rendere la vita più positiva. Ricercando questi valori ho lavorato con materiali naturali enfatizzandone le caratteristiche estetiche e tecniche alla ricerca di una forma pulita ed essenziale in grado di adattarsi ai pensieri delle persone."

"It is expected that a library is as solid as the concrete, it is really adaptable to the needs of storage, it is flexible, aggregated, interpreted over time so as to make life more positive. By researching these values I have worked with natural materials emphasizing the aesthetic and technical characteristics, looking for a clean and simple form adaptable to the thoughts of people."

Complemento Complement

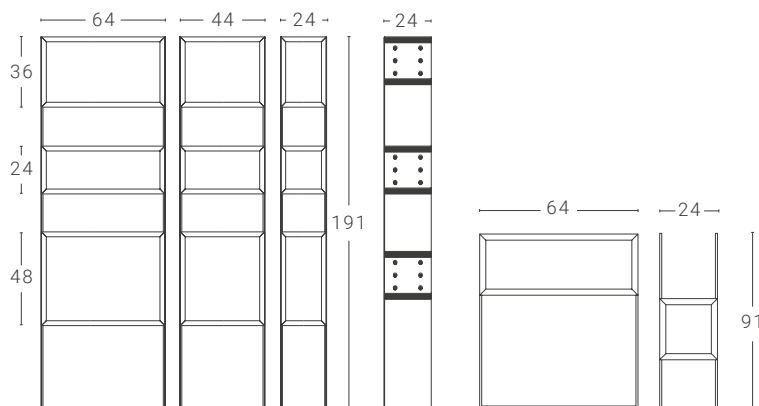

Libreria modulare.
Cubi in legno posizionabili in altezza a piacere.
Modular Bookshelf.
Wooden cube adjustable up and down as you wish.

Materiale Material

Ferro, legno di pioppo naturale
Iron, wood con "natural poplar wood"

Finiture Colours

● Blu di laminazione Iron blu

Finitura disponibili solo in versione opaca
Finish available only in matt version



Dema

Design: Franco Zavarise

Quattro gambe che si aprono a cono legate tra loro con un anello e sormontate da un disco in metallo. Questo è Dema. Un sistema di tavolini da bar e di sgabelli alti (con o senza schienale) coordinati. Una linea molto caratterizzata e unica nel suo genere, grazie al suo design ironico e inconfondibile...

Four legs that open up like a cone tied together with a ring and surmounted by a metal disk. A system of coordinated bar tables and high stools with very distinctive and unique style thanks to its ironic and unmistakable design...

Set di tavolino e sgabelli

Set of table and stools

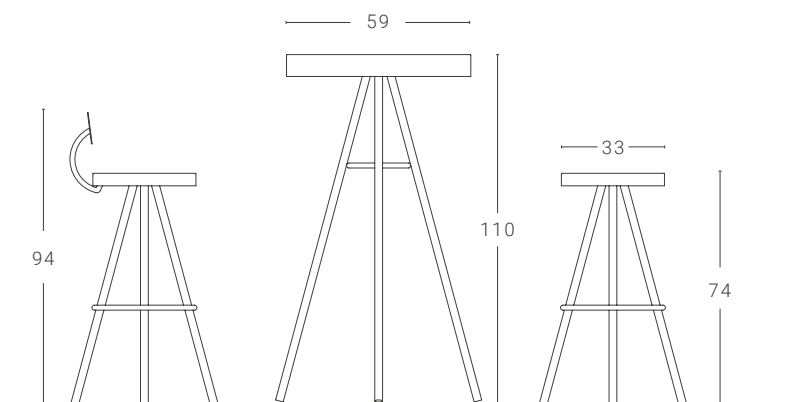

Materiale Material

Ferro
Iron

Finiture Colours

○ RAL 9010

● RAL 9005

● Sahara

● Blu di laminazione Iron blu

Finiture disponibili solo in versione opaca
Finishes available only in matt version



Jooke

Design: Delineodesign & Franco Zavarise

Set di sgabelli e tavolino in ferro blu di laminazione trattato con protettivo trasparente, girevole e regolabile in altezza.

Set of stools and table in blue iron, treated with a protective transparent lacquering. It is swivel seat adjustable in height.

Set di tavolino e sgabelli Set of table and stools

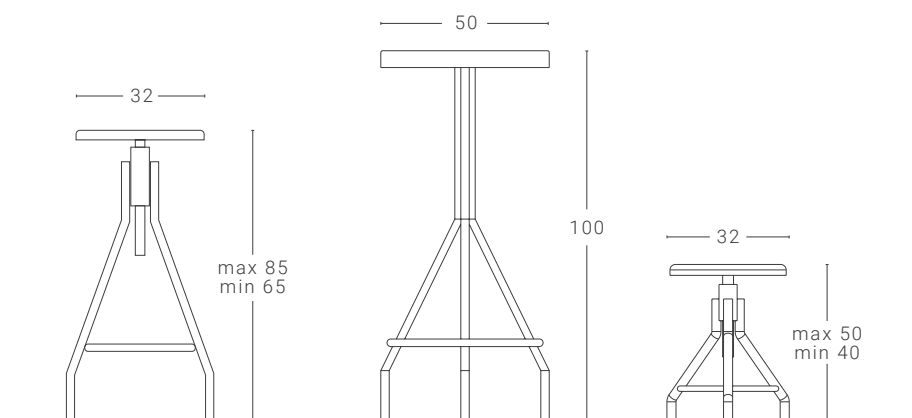

Materiale Material

Ferro
Iron

Finiture Colours

- RAL 9005
- RAL 9010
- Blu di laminazione Iron blu
- Verde artico Arctic green

Finiture disponibili solo in versione opaca
Finishes available only in matt version



Ragno

Design: Franco Zavarise

Ragno è un sistema sgabelli e tavolini bar leggeri, pratici e dalle linee essenziali. La collezione Ragno è caratterizzata dalle sue 8 lunghe gambe che si uniscono, a due a due, nei punti di contatto a terra. Il top coordinato, dal profilo sottilissimo, mette ancor più in evidenza la lunghezza dell'esile struttura.

Ragno is an easy stools and bar tables system made out of essential lines. The Ragno collection is characterized by its 8 long legs that come together two by two on the ground. The coordinated top with a very thin profile highlights its slender design.

Set di tavolino e sgabelli

Set of table and stools

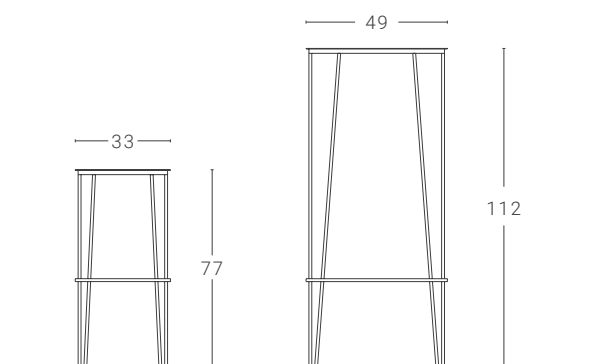

Materiale Material

Ferro
Iron

Finiture Colours

○ RAL 9010

● Blu oceano Ocean blue

● Blu di laminazione Iron blu

● RAL 9005

● RAL 2004

Finiture disponibili solo in versione opaca
Finishes available only in matt version



Street

Design: Franco Zavarise

Un volume semplice e geometrico caratterizza la collezione Street, un sistema di sedute e tavolini in metallo lavorato con taglio a laser e piegato. Street si distingue, oltre che per la sua linea dinamica, per la superficie in lamiera di alluminio "mandorlata", con la tipica finitura zigrinata "antiscivolo" dei marciapiedi, delle piattaforme e delle scale industriali.

A simple and geometric volume characterizes the Street collection: a seating system and side-tables made out of laser-cut and bent metal. Street stands out for its dynamic line but also for its "mandorlata" aluminium sheet surface, characterized by an "anti-slippering" usually found on the sidewalks platforms and industrial stairs.

Complemento Complement

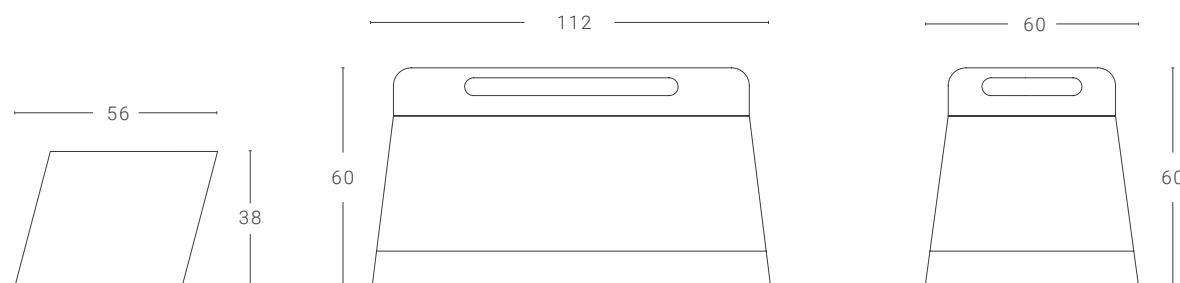

Materiale Material

Alluminio
Aluminium

Finiture Colours

- RAL 9010
- RAL 9005
- Verde artico Arctic green

Finiture disponibili solo in versione opaca
Finishes available only in matt version



Street

Design: Franco Zavarise

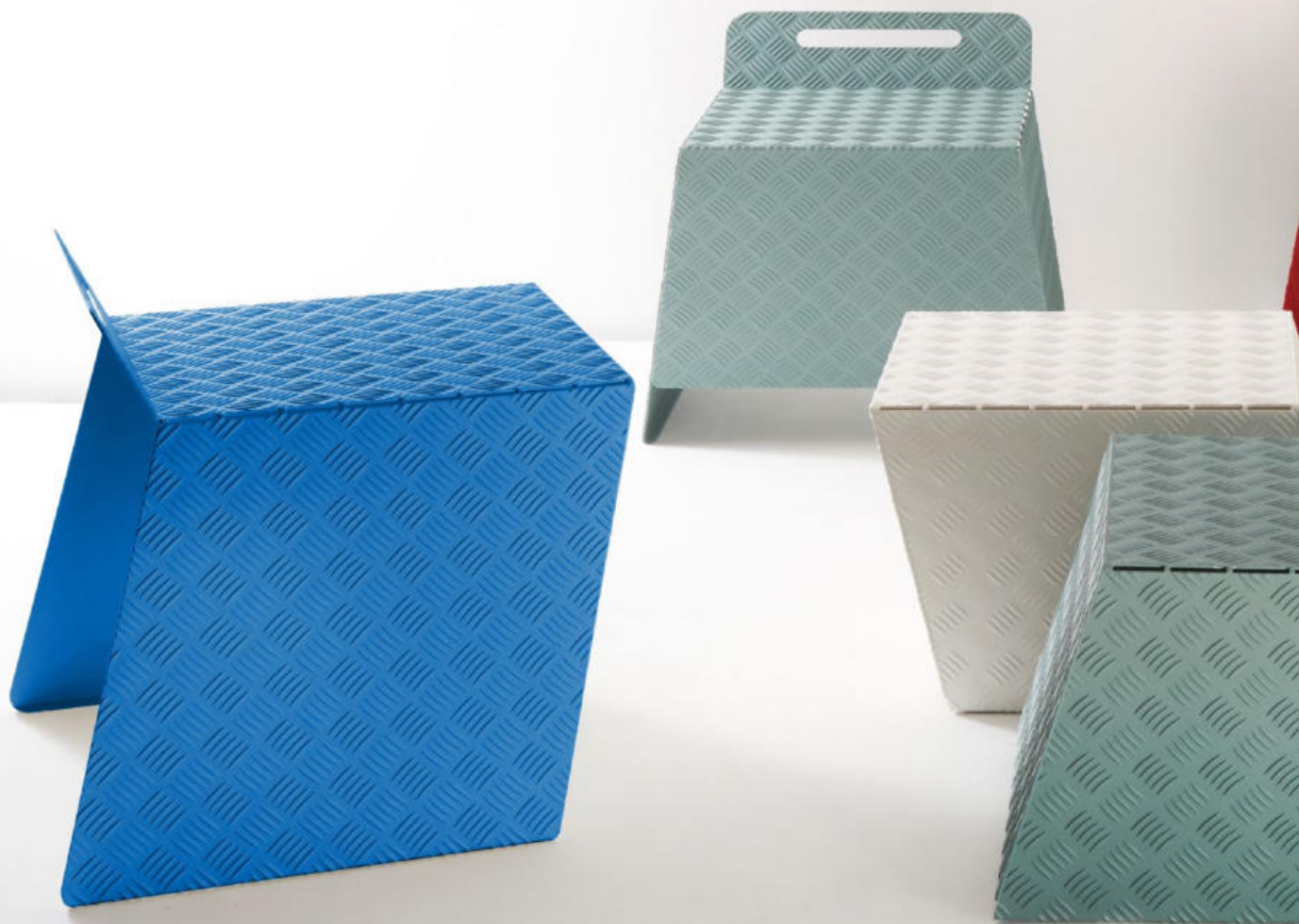



Tank

Design: Delineodesign

Adatti ad ogni ambiente, questi bidoni in ferro, chiusi su entrambi i lati possono essere utilizzati come tavolini d'appoggio o come espositori.

Suitable for any environment, these bins made out of iron, are closed on both sides and can be used as backing tables or as exhibitors.

Complemento Complement

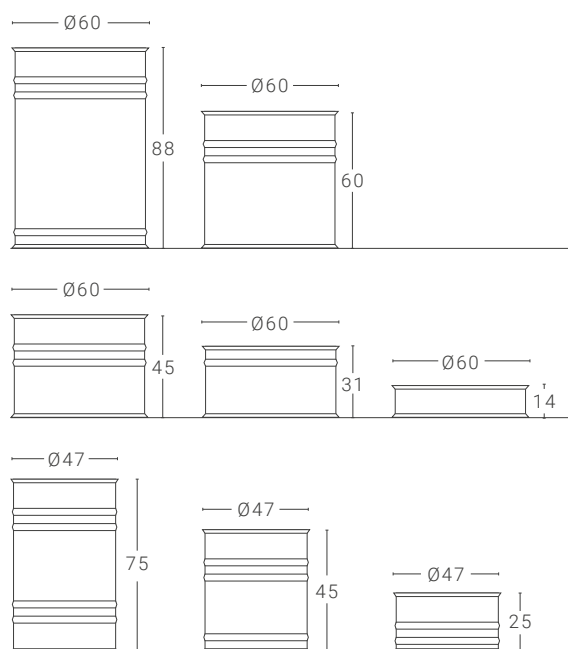

Disponibile sia per interno che per esterno.
Indoor and outdoor version available.

Materiale Material

Interno: ferro.
Esterno: acciaio inox 430
Indoor: iron
Outdoor: stainless steel 430

Finiture Colours

- | | | |
|------------|-----------------------------|-------------------------------|
| ○ RAL 9010 | ● Blu oceano Ocean blue | ● Blu di laminazione Iron blu |
| ● RAL 9005 | ● Verde artico Arctic green | |

Finiture disponibili solo in versione opaca
Finishes available only in matt version



Tico

Design: Franco Zavarise

Libreria componibile in alluminio, disponibile in diverse finiture, anche con interno in colore a contrasto.

Nella versione a soffitto, il tubo centrale di sostegno può essere regolato in base all'altezza della stanza.

Modular bookshelf in aluminium, available in different finishes and also with contrasting interior colour. In the ceiling version the central supporting pole can be adjusted to fit the height of the room.

Complemento Complement

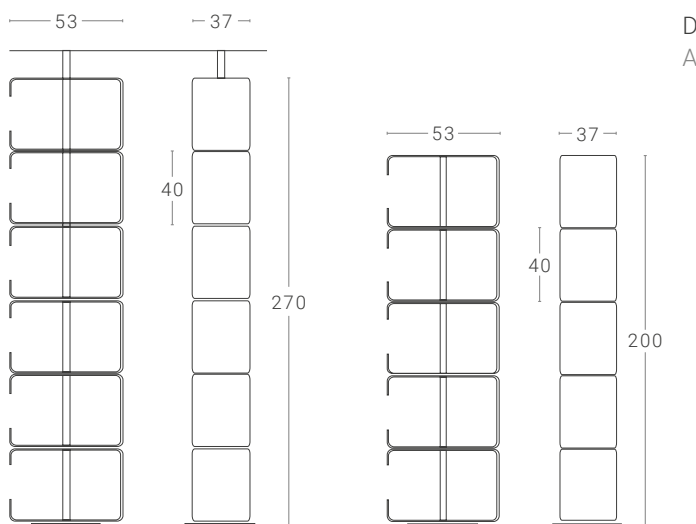

Disponibile in due versioni. "Tico Big" e "Tico Small"
Available in two versions. "Tico Big" and "Tico Small"

Materiale Material

Alluminio, ferro, acciaio
Aluminium, iron, steel

Finiture Colours

- RAL 9010
- RAL 9005

Finiture disponibili solo in versione opaca
Finishes available only in matt version



Finiture

Finishes

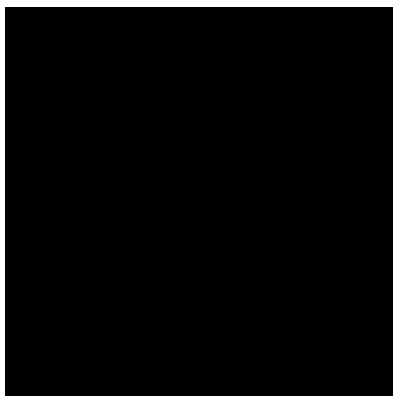

RAL 9005
Nero intenso Jet black

Lucido/Glossy: cod. 102
Opaco/Matt: cod. 202



RAL 7044
Grigio seta opaco
Matt silk grey

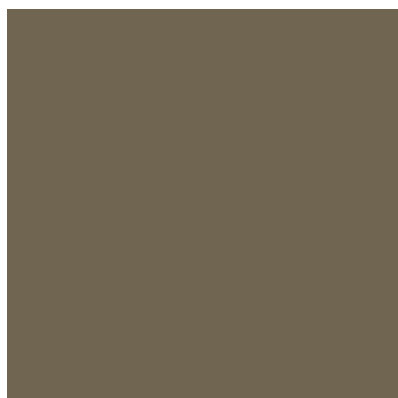

RAL 7006
Grigio beige Beige grey

Lucido/Glossy: cod. 115
Opaco/Matt: cod. 215



RAL 1019
Beige grigiastro Grey beige

Lucido/Glossy: cod. 108
Opaco/Matt: cod. 208



RAL 3002
Rosso carminio
Carmine red

Lucido/Glossy: cod. 104
Opaco/Matt: cod. 204



RAL 2004
Arancio puro
Pure orange

Lucido/Glossy: cod. 109
Opaco/Matt: cod. 209



RAL 1028
Giallo melone opaco
Matt melon yellow



RAL 1003
Giallo segnale
Signal yellow

Lucido/Glossy: cod. 110
Opaco/Matt: cod. 210

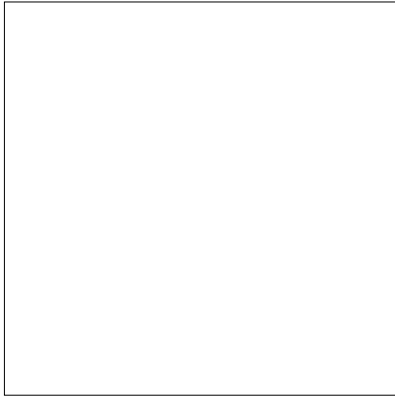

RAL 9010
Bianco puro Pure white
Lucido/Glossy: cod. 103
Opaco/Matt: cod. 203



Grigio metallizzato
Metalized grey
Lucido/Glossy: cod. 118

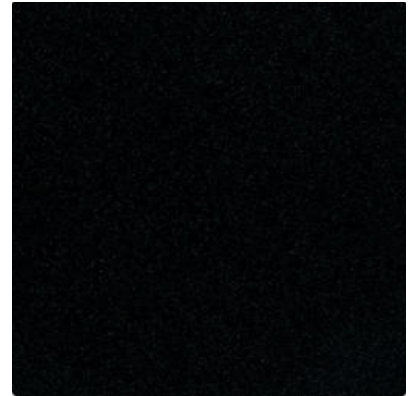

Nero micaceo
Micaceous black
Opaco/Matt: cod. 220



Bronzo metallizzato
Metalized bronze
Opaco/Matt: cod. 219



Effetto corten
Corten effect
Opaco/Matt: cod. 222

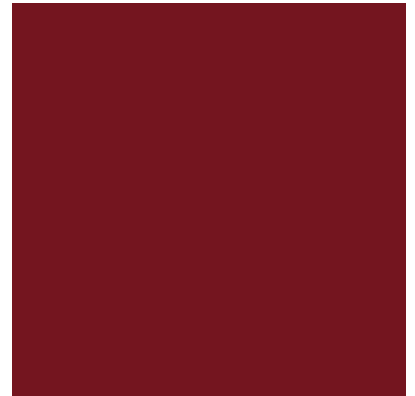

RAL 3004
Rosso porpora
Purple red
Lucido/Glossy: cod. 105
Opaco/Matt: cod. 205



RAL 6018
Verde giallastro
Yellow green
Lucido/Glossy: cod. 112
Opaco/Matt: cod. 212



RAL 5010
Blu genziana
Gentian blue
Lucido/Glossy: cod. 114
Opaco/Matt: cod. 214



RAL 6034
Turchese pastello
Pastel turquoise
Lucido/Glossy: cod. 111
Opaco/Matt: cod. 211

Colori novità New colours



Rosa quarzo
Quartz pink

cod. 231



Moon stone

cod. 223

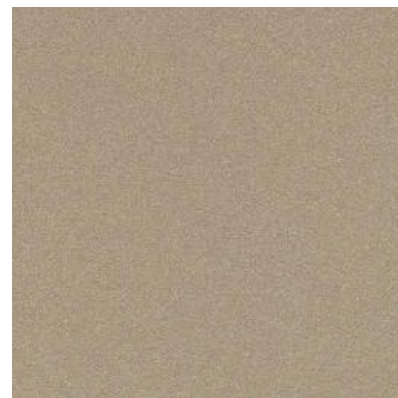

Sahara

cod. 227



Verde Salvia
Sage green

cod. 224



Verde artico
Arctic green

cod. 225

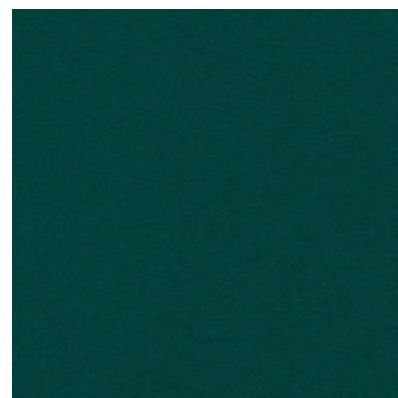

Verde giungla
Jungle green

cod. 226

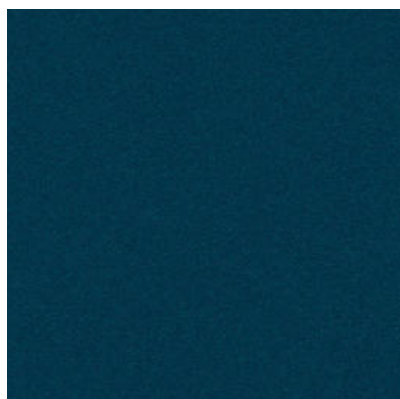

Blu oceano
Ocean blu

cod. 229



Grigio basalto
Basalt grey

cod. 230



Grigio diaspro
Jasper grey

cod. 228

Finiture speciali Special finishes

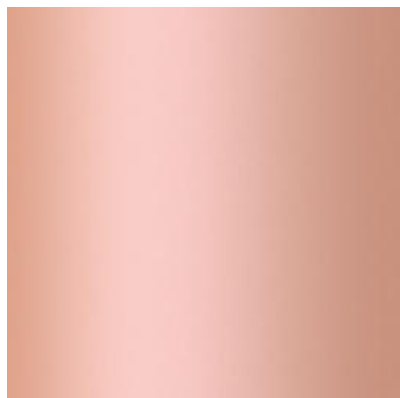

Finitura ramata
Copper finish

cod. 309



Finitura oro
Gold finish

cod. 305



Finitura cromata
Chrome finish

cod. 306



Verde rame
Copper green

cod. 303



Nero raggrinzante
Wrinkled black

cod. 308

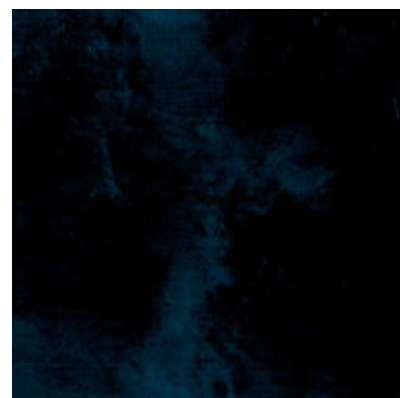

Blu di laminazione
Blue iron

cod. 301

Granatura ecomalta® Ecomalta® grain

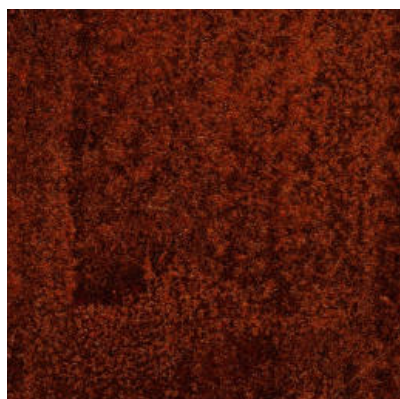

Ruggine naturale
Natural rust finish

cod. 302



Fina
Thin



Media
Medium

Finiture ottone Brass finishes



Satinato
Satined



Spazzolato
Brushed



Brunito satinato chiaro
Light satined burnished



Brunito satinato scuro
Dark satined burnished



Fiammato
Flamed

Finiture in foglia Leaf finishes



Foglia argento
Silver leaf



Foglia oro
Gold finish

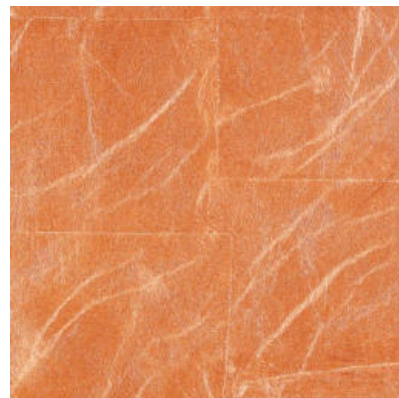

Foglia rame
Copper finish

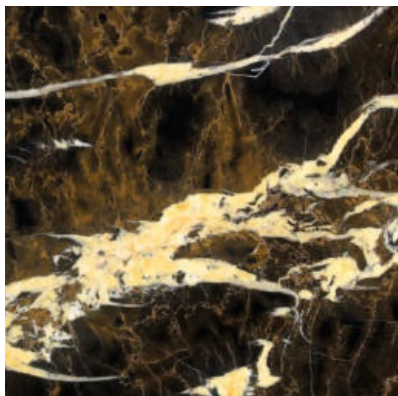

Black and gold



Breccia paradiso

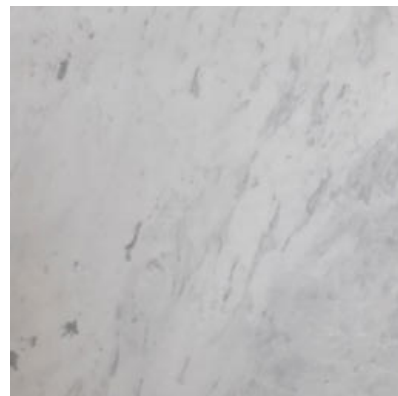

Crema olimpia

Colori cavi in tessuto

Fabric cable colours



Rayon bianco / White rayon

cod. G



Poliestere grigio topo / Mouse grey colour

cod. I



Rayon nero / Black rayon

cod. F



Rayon azzurro royal / Royal azure blue rayon

cod. E



Rayon verde prato / Lawn green rayon

cod. D



Rayon giallo mais / Maize yellow rayon

cod. B



Rayon arancio / Orange rayon

cod. C



Rayon rosso scarlatto / Scarlet red rayon

cod. A



Rayon ciclamino / Cyclamen rayon

cod. H

Condizioni generali di vendita

Validità dal 01.09.2023

PREMESSE

Le presenti condizioni generali di vendita e le loro future modifiche si applicano a tutti gli ordini inviati dal Cliente ed accettati da Zava Srl, quindi a tutti i futuri contratti tra le Parti. Le stesse sono modificabili da Zava Srl a mezzo e-mail, PEC o fax.

DEFINIZIONI

Cliente: persona giuridica che acquistare per rivendere a privati consumatori i Prodotti venduti da Zava Srl, sia con il proprio marchio, che con altri marchi;
Parti: congiuntamente Zava Srl ed il Cliente; Prodotti: tutti i prodotti commercializzati da Zava Srl.

1. INVIO DELL'ORDINE

L'invio anche telematico di ordini da parte del Cliente costituisce proposta irrevocabile di acquisto condizionata alla conferma di Zava Srl e comporta l'accettazione del Cliente delle condizioni generali di vendita qui accordate e specificate.

2. PREZZI

I prezzi indicati nei listini e concordati nella conferma d'ordine salva diversa indicazione non comprendono le spese di consegna. Ricevuto l'ordine, Zava Srl si riserva di variare i prezzi inviando una nuova proposta contrattuale. Decorsi 3 giorni dall'invio della nuova proposta senza che il Cliente eccepisca alcunché, i prezzi si intenderanno accettati. Particolari accordi sono validi solo per il singolo ordine.

3. TRASPORTI

Nei trasporti a carico di Zava Srl, in caso di perdita dei Prodotti, Zava Srl potrà a propria scelta sostituire i prodotti e/o annullare l'ordine, con restituzione delle somme, o dei titoli ricevuti.

4. VIZI E DIFETTI - DECADENZA - PRESCRIZIONE.

Lo stato ed il numero degli imballi, i Prodotti e la conformità all'ordine devono verificarsi al momento della consegna. Discordanze riguardanti quantità, o tipologia, dovranno essere segnalate entro 48 ore dal ricevimento della merce tramite PEC, e-mail, o fax, indicando i dati necessari per un'immediata verifica. Decorso il termine la merce sarà considerata come accettata. Nel caso in cui il Cliente scopra vizi e/o difetti dei Prodotti in un momento successivo, perché occulti, dovrà denunciare per iscritto entro 8 (otto) giorni dall'accertamento, ma entro un anno dal ricevimento quale termine di prescrizione.

5. RESI - PROCEDURA DI SEGNALAZIONE DI VIZI E DIFETTI

In ogni caso di segnalazione di vizi o difetti, il Cliente deve comunicare per iscritto a Zava Srl la tipologia di apparecchio, gli estremi della fornitura (DDT, fattura di acquisto, eventuale fattura - scontrino di vendita a terzi), il luogo di installazione, il difetto riscontrato, con immagini e/o video comprovanti e descrittive del difetto. La comunicazione dev'essere inviata all'indirizzo e-mail servizioclienti@zavasrl.it o customerservice@zavasrl.it. Zava Srl si riserva quindi di autorizzare in forma scritta il reso per la spedizione del materiale da verificare. Non saranno accettati resi per i quali non è stata ammessa regolare autorizzazione. Ricevuto il materiale, Zava Srl analizzerà il guasto e comunicherà al cliente se lo stesso rientra nella garanzia. Se il vizio o difetto è coperto da garanzia, Zava Srl potrà decidere a propria discrezione se eseguire la riparazione, sostituire il prodotto, o restituire il prezzo di acquisto. Se il vizio e difetto non è coperto da garanzia, Zava Srl comunicherà al cliente se il prodotto è riparabile e con quali costi. Se i prodotti non dovessero risultare difettosi, Zava Srl potrà addebitare all'acquirente le spese sostenute per le verifiche tecniche e il trasporto.

6. LIMITAZIONI DI RESPONSABILITÀ

In caso di riconoscimento dei vizi e difetti tempestivamente segnalati dal Cliente, Zava Srl ha la facoltà di riparare, o sostituire il prodotto, o di accreditare il prezzo di acquisto al Cliente. L'eventuale responsabilità di Zava Srl per vizi e difetti dei Prodotti non potrà superare il valore dei/i Prodotti difettosi, sulla base dei prezzi di vendita/acquisto applicati al Cliente. Resta esclusa ogni diversa responsabilità, o richiesta risarcitoria del Cliente, anche per danni diretti ed indiretti, mancati guadagni, danno all'immagine.

7. TERMINI

Il termine di consegna è indicativo e decorrerà dal pagamento della caparra o, se prevista, dalla consegna dei documenti tecnici - amministrativi - normativi necessari per la produzione. Eventuali ritardi non danno diritto al Cliente di annullare l'ordine, né a risarcimenti danni, non costituendo grave inadempimento ai sensi dell'art. 1455, c.c., salvo i limiti inderogabili di legge. Eventuali cause di forza maggiore autorizzano Zava Srl a recedere in tutto o in parte dal contratto.

8. PAGAMENTI - SOSPENSIONE - ANNULLAMENTO DELL'ORDINE

I pagamenti devono essere eseguiti a Zava Srl, alle specifiche condizioni indicate nella conferma d'ordine. In caso di mancato rispetto delle condizioni di pagamento (ad esempio mancato pagamento anticipato, mancata consegna della caparra o di titoli, mancata presentazione di garanzie), o in caso di mancato adempimento delle altre obbligazioni indicate nella conferma d'ordine, Zava Srl potrà sospendere l'esecuzione dell'ordine e, decorsi giorni 15 dall'invio di una diffida ad adempiere, avrà la facoltà discrezionale di annullare l'ordine destinando i prodotti ad altri clienti, o diverso utilizzo, salvo il risarcimento del danno.

9. DIVIETO DI SOSPENSIONE PAGAMENTI

È concordato che eventuali reclami, azioni e/o eccezioni del Cliente, non autorizzano la sospensione dei pagamenti dei prodotti contestati, né di altre vendite. Il Cliente dovrà quindi rispettare le scadenze di pagamento, con diritto da parte di Zava Srl, in caso contrario, di procedere con l'azione esecutiva per il pagamento.

10. INTERESSI MORATORI

In caso di mancato pagamento nei termini pattuiti, dal giorno successivo alla scadenza decorreranno gli interessi moratori di legge.

11. CONSEGNA

Se la consegna è ritardata dal cliente, il pagamento seguirà ad avviso di merce pronta.

12. DECADENZA DAL BENEFICIO DEL TERMINE

In caso di accordo di pagamento dilazionato, il mancato rispetto di una scadenza determina la decadenza dal beneficio del termine, ai sensi dell'art. 1186, c.c., con diritto di Zava Srl di chiedere, a suo insindacabile giudizio, l'immediato saldo del prezzo della vendita, o la risoluzione immediata del contratto per inadempimento del Cliente, salvo il pagamento delle prestazioni rese ed il risarcimento del danno.

13. DIVIETO DI CESSIONE

I singoli ordini e le relative obbligazioni non sono trasferibili dal Cliente.

14. SOSPENSIONE - ANNULLAMENTO DEGLI ORDINI

Salvo quanto specificato al precedente art. 8, Zava Srl ha la facoltà di sospendere, o annullare, in tutto o parte, i singoli ordini, salvo il risarcimento del danno, al verificarsi delle seguenti fattispecie che riguardano il Cliente:

- Mancato pagamento, anche parziale, di scadenze di pagamento, anche su ordini precedenti;
- Venir meno delle garanzie prestate con l'ordine e/o in separato accordo;
- Violazione del divieto di cessione di cui al precedente art. 13.;
- Manifestarsi di uno stato generale d'insolvenza, anche verso terzi;
- Mancato rispetto delle condizioni di vendita stabilite nell'ordine e/o in separato accordo contrattuale a seguito di diffida ad adempiere nel termine minimo di 15 giorni.

15. PUBBLICITÀ

Per pubblicizzare con foto od altri mezzi sia i Prodotti commercializzati da Zava Srl sia a marchio Zava sarà necessaria la preventiva autorizzazione scritta della stessa.

16. LEGGE - GIURISDIZIONE - FORO

I rapporti tra le Parti sono regolati dalla legge e giurisdizione italiana. Ogni controversia tra le Parti sarà di competenza esclusiva del Tribunale di Treviso.

17. NORME CONCLUSIVE

Qualora una o più clausole delle presenti Condizioni Generali di Vendita risultino nulle, o annullabili, le altre clausole rimarranno valide.

LISTINO PREZZI 2022

Il presente listino sostituisce ed annulla i precedenti. Il cliente conferendo l'ordine, conferma integralmente le seguenti condizioni di vendita.

VALIDITÀ: Il presente listino verrà applicato su tutti gli ordini caricati a partire dal 01 Ottobre 2022.

PREZZI: I prezzi indicati sono espressi in Euro (€) e si intendono tutti IVA esclusa.

FUORI MISURA: È possibile eseguire verniciature di colori presenti nella scheda colori con una maggiorazione a partire 10% . Per le lavorazioni speciali contattare l'ufficio tecnico per indagarne la fattibilità e ricevere eventuale preventivo.

MODIFICHE: L'azienda si riserva il diritto di apportare in qualsiasi momento modifiche di disegno o tecniche ai prodotti, senza obbligo di preavviso.

MISURE: Viste le caratteristiche del prodotto, le dimensioni dei prodotti, indicate a listino, possono avere una tolleranza compresa tra +/- 2 cm.

TERMINE DI CONSEGNA: Il termine di consegna sulla conferma d'ordine è unicamente a carattere indicativo, dipendendo a nostra volta dal puntuale ricevimento delle materie prime. La ritardata o mancata consegna dovuta a cause di forza maggiore, imprevisti, contenziosi, non costituiranno in nessun caso diritto di rivalsa, penalità, indennizzo o lucro cessante. La ditta si riserva il diritto di sospendere le consegne in qualunque caso di inadempienza, anche parziale, dell'acquirente agli obblighi assunti.

CONCLUSIONI: Resta inteso che la vendita della merce viene effettuata con la clausola di patto di riservato dominio, per cui la proprietà della merce passerà all'acquirente solamente quando ne avrà pagato integralmente in prezzo e, se stabilito a rate, solamente con il pagamento dell'ultima rata. In caso di mancato pagamento di due terzi dell'importo totale da corrispondere, la ditta venditrice avrà il diritto di ritirare la merce senza restituzione della parte pagata che tratterrà a titolo di rimborso danni, salvo quelli ulteriori per lo stato dei materiali al momento della restituzione. Per qualsiasi controversia sarà competente il foro di Treviso. Il pagamento, anche se stabilito con tratte, non sposta il foro di competenza.

General terms and conditions of sale

Valid from 01.09.2023

PREAMBLE

These general terms and conditions of sale and their future modifications apply to all orders sent by the Customer and accepted by Zava Srl, therefore to all future contracts between the Parties. They can be modified by Zava Srl by e-mail, PEC (certified e-mail) or fax.

DEFINITIONS

Customer: a legal person who purchases the Products sold by Zava Srl to resell them to private consumers, both under its own trademark and with other trademarks;
Parties: jointly Zava Srl and the Customer; Products: all products marketed by Zava Srl.

1. SENDING THE ORDER

The sending of orders also electronically by the Customer constitutes an irrevocable proposal of purchase conditional upon confirmation by Zava Srl and implies the Customer's acceptance of the general terms and conditions of sale agreed and specified herein.

2. PRICES

The prices indicated in the price lists and agreed in the order confirmation unless otherwise specified do not include delivery costs. Upon receipt of the order, Zava Srl reserves the right to change the prices by sending a new contractual proposal. For 3 days after the new proposal is sent, if no objection is raised by the Customer, the prices will be considered accepted. Special agreements are valid only for the individual order.

3. TRANSPORTATION

In case of loss of the Products, Zava Srl may, at its own discretion, replace the products and/or cancel the order, with refund of the amounts or goods received.

4. FAULTS AND DEFECTS - FORFEITURE - LIMITATION

The condition and the number of packages, Products and the compliance to the order must be checked at the time of delivery. Any discrepancies regarding quantity, or type, must be reported within 48 hours of receipt of the goods by certified e-mail (PEC), e-mail, or fax, specifying the details necessary for immediate verification. After the deadline, the goods will be considered accepted. In the event the Customer discovers defects and/or faults in the Products at a later date, because they were hidden, they must report such defects and/or faults in writing within 8 (eight) days from the discovery, but at maximum within one year from the receipt of products, which is the limitation period.

5. RETURNS - PROCEDURE FOR REPORTING FAULTS AND DEFECTS

In any case of reporting of faults or defects, the Customer must inform Zava Srl in writing the type of device, the details of the supply (transport document, purchase invoice, any invoice - receipt of sale to third parties), the place of installation, the defect found, with images and/or videos proving and describing the defect. The communication must be sent to servizioclienti@zavasrl.it or customerservice@zavasrl.it. Zava Srl therefore reserves the right to authorise in writing the return for the shipment of the material to be verified. Returns for which regular authorisation has not been granted will not be accepted. Upon receipt of the material, Zava Srl will analyse the fault and inform the customer if it is covered by the warranty. If the fault or defect is covered by warranty, Zava Srl may decide at its own discretion whether to repair, replace the product, or reimburse the purchase price. If the fault or defect is not covered by the warranty, Zava Srl will inform the customer if the product is repairable and how much the repair will cost. If the products are not found to be defective, Zava Srl may charge the buyer for the costs incurred for technical checks and transportation.

6. LIMITATIONS OF LIABILITY

In case of recognition of defects and faults promptly reported by the Customer, Zava Srl has the right to repair, or replace the product, or to credit the purchase price to the Customer's account. Any liability of Zava Srl for defects and faults in the Products shall not exceed the value of the defective Product(s), based on the sales/purchase prices charged to the Customer. Any other liability, or request for compensation of the Customer, including for direct and indirect damages, lost earnings, damage to the image, is excluded.

7. TIME LIMITS

The delivery time is indicative and will start from the payment of the deposit or, if provided, from the delivery of the technical - administrative - regulatory documents necessary for the production. Any delays do not entitle the Customer to cancel the order, nor to claim compensation for damages, since they do not constitute a serious breach within the meaning of Article 1455 of the Italian Civil Code, subject to the mandatory limits of law. Any causes of force majeure authorise Zava Srl to withdraw in whole or in part from the contract.

8. PAYMENTS - SUSPENSION - CANCELLATION OF THE ORDER

Payments must be made to Zava Srl, under the specific conditions indicated in the order confirmation. In case of non-compliance with the payment conditions (e.g. failure to pay in advance, non-delivery of the deposit or securities, failure to provide guarantees), or in case of failure to comply with the other obligations indicated in the order confirmation, Zava Srl may suspend the execution of the order and, after 15 days from the sending of a notice to comply, will have the discretionary right to cancel the order by allocating the products to other customers, or other use, without prejudice to compensation for damages.

9. PROHIBITION OF SUSPENSION OF PAYMENTS:

It is agreed that any complaints, actions and/or exceptions of the Customer, do not authorise the suspension of payments for the disputed products, or other sales. The Customer must therefore respect the payment deadlines and in case of failure to do so, Zava Srl will be entitled to proceed with the enforcement action for the payment.

10. DEFAULT INTEREST:

In case of non-payment by the agreed deadline, default interest will start to accrue from the day after the due date.

11. DELIVERY

If delivery is delayed by the customer, payment will follow upon receipt of the notice that the goods are ready for shipment.

12. ACCELERATION CLAUSE

In case of deferred payment agreement, the failure to comply with a deadline determines the acceleration clause, pursuant to Article 1186 of the Italian Civil Code, with the right of Zava Srl to request, at its sole discretion, the immediate payment of the sale price, or the immediate termination of the contract for non-fulfilment by the Customer, except for the payment of the services rendered and compensation for damages.

13. PROHIBITION OF TRANSFER

Individual orders and related obligations are not transferable by the Customer.

14. SUSPENSION - CANCELLATION OF ORDERS:

Except as specified in Article 8 above, Zava Srl has the right to suspend, or cancel, in whole or in part, individual orders, except for compensation for damages, upon the occurrence of the following cases concerning the Customer:

- Non-payment, even partial, by payment deadlines, even for previous orders;
- The guarantees given in the order and/or in a separate agreement shall lapse;
- Infringement of the prohibition of transfer referred to in Article 13 above;
- Manifesting a general state of insolvency, even towards third parties;
- Failure to comply with the terms of sale set out in the order and/or in a separate contractual agreement as a result of a warning to comply within a minimum period of 15 days.

15. ADVERTISING

In order to advertise with photos or other means both the Products marketed by Zava Srl and with the Zava trademark, the prior written authorisation for the same is required.

16. LAW - JURISDICTION - COURT

The relations between the Parties are governed by Italian law and jurisdiction. Any dispute between the Parties shall fall under the exclusive jurisdiction of the Court of Treviso.

17. FINAL RULES

Should one or more clauses of these General Terms and Conditions of Sale be null and void, the other clauses shall remain valid.

PRICE LIST 2024

This price list replaces and cancels the previous versions. By placing the order, the customer fully accepts the following conditions of sale.

VALIDITY: This price list will be applied to all orders received from 01 October 2022.

PRICES - The prices indicated are expressed in Euros (€) and are all exclusive of VAT.

OUTSIDE MEASUREMENT: It is possible to paint the colours on the colour card with an increase starting from 10% in the price. For special work, please contact the technical office to check the feasibility and receive a quote.

MODIFICATIONS: The company reserves the right to make design or technical changes to the products at any time, without prior notice.

MEASUREMENTS: Given the characteristics of the product, the dimensions of the products, indicated in the price list, can have a tolerance between +/- 2 cm.

DELIVERY TIME: The delivery time on the order confirmation is only indicative, depending in turn on the timely receipt of the raw materials. Delayed or non-delivery due to force majeure, unforeseen events, litigation, will in no case constitute a right of recourse, penalty, compensation or loss of profit. The company reserves the right to suspend deliveries in case of non-compliance, even partial, with the obligations undertaken by the purchaser.

CONCLUSIONS: It is understood that the sale of the goods is carried out under the title retention agreement clause, so the ownership of the goods will be passed on to the buyer only when he has paid the full price and, if agreed in instalments, only with the payment of the last instalment. In case of non-payment of two-thirds of the total amount to be paid, the Seller shall have the right to take back the goods without refunding the partially paid price which it will keep as a reimbursement for damages, except for further damages due to the status of the materials at the time of return.

All disputes arising from this contract shall be settled by the Court of Treviso. The payment, even if agreed with drafts, does not change the jurisdiction.

Simboli Symbols

IP

Prodotto protetto contro l'intrusione di particelle solide e l'accesso di liquidi.

Product protected against intrusion of solid particles and access of liquids.



Ai sensi della direttiva 2002/96/CE, il prodotto, alla fine della sua vita utile, non deve essere smaltito come rifiuto urbano. Under the directive 2002/96/CE, the product, at the end of its life, mustn't be disposed of as urban waste.

CE

Attesta la conformità del prodotto alle disposizioni delle direttive comunitarie. Certify compliance for the product of the community directives.

I dati riportati in questo catalogo sono indicativi e non costituiscono impegno da parte di ZAVA che si riserva il diritto di apportare tutte le modifiche e migliorie che riterrà necessarie senza l'obbligo di preavviso. Tutti i modelli rappresentati in questo catalogo sono rispondenti a quanto prescritto dall'insieme di pratiche obbligatorie raggruppate nell'ambito della marcatura CE. La marcatura CE attesta che gli apparecchi d'illuminazione rispondono a tutti i requisiti minimi essenziali richiesti dalla Direttiva Comunitaria CEE 73/23 e relativa modifica CEE 93/68. A tale proposito, gli stessi apparecchi, sono stati progettati e costruiti in conformità alle Norme armonizzate CEI EN 60598-1 - VIII EDIZIONE. I nostri uffici commerciali rimangono a vostra completa disposizione per qualsiasi ulteriore delucidazione.

I colori riportati nel catalogo sono indicativi.

Tutte le misure sono espresse in centimetri.

The data in this catalogue are indicative and do not constitute a commitment on the part of ZAVA, which reserves the right to make any changes and improvements it may deem necessary without prior notice. All the models shown in this catalogue comply with the requirements of the set of mandatory practices grouped together under the CE marking. The CE marking attests that the luminaires meet all the minimum essential requirements of the Community Directive EEC 73/23 and its amendment EEC 93/68. In this respect, the same appliances, have been designed and constructed in accordance with the CEI EN 60598-1 - VIII EDITION. Our sales offices remain at your disposal for any further elucidation. The colours shown in the catalogue are indicative. All measurements are in centimeters.



Via Padova, 48 -
31041 Cornuda (TV)
t. +39 0423 639907
f. +39 0423 821639
customerservice@zavasrl.it

www.zavaluce.it

**L'azienda si riserva di
apportare modifiche e
migliorie senza preavviso.**

The company reserves to
make changes and improve-
ments without notice.

Concept and graphic project:
_ Delineodesign comunicazione

Styling:
_ Patrizia Toffolo

Photography:
_ Paolo Gamelli
_ Studio Fuoco

Art director:
_ Massimo Rosati

Print:
_ Tipografia Asolana

Printed in Italy
Release n° 3 _ Settembre 2023

zavaluce.it