



TECNICO[®]
N A T U R A L L I G H T

TECNICO[®]
N A T U R A L L I G H T



Materiali - Gesso

Le forme di Tecnico nascono dalle infinite possibilità date dall'utilizzo del gesso, un materiale naturale, ideale sotto l'aspetto ecologico e bioedile perché atossico, con un pH neutro e non risulta combustibile. I prodotti di Tecnico sono pensati per integrarsi con l'architettura domestica contemporanea e per durare nel tempo.

Tutti i prodotti Tecnico utilizzano sorgenti luminose (LED integrati o lampadine LED) ad alta efficienza, che emettono quindi una grande quantità di luce a fronte di un consumo contenuto.

Analisi infrarossa sui gessi Tecnico da parte del Laboratorio di prova Catas S.p.A.: l'analisi è stata condotta con la tecnica ATR per contatto diretto del prodotto con il cristallo del sensore. Lo spettro infrarosso risultante mostra nella materia del prodotto la sola presenza di Solfato di Calcio Bivalente, conosciuto con il nome comune di Gesso.

Materials - Gypsum

Materials - Gypsum

Tecnico's shapes are inspired by the gypsum's endless use possibilities. This natural material is excellent for environmentally-friendly and green building purposes, because it is non-toxic, with a neutral pH and non-combustible.

Tecnico's products are designed to blend in with contemporary residential architecture and to last over time. All of Tecnico's products use high efficiency lighting sources (build-in LEDs or LED lights), which emit a lot of light with limited energy consumption.

Infrared analysis on Tecnico gypsum, by the Catas S.p.A. testing lab: the analysis has been carried out with the ATR technique, with direct product contact with the sensor crystal. The resulting infrared spectrum shows only the presence of calcium sulphate dihydrate - commonly known as Gypsum - in the product material.

Materialien - Gips

Die Formen von Tecnico ergeben sich aus den unendlichen Möglichkeiten, die die Verwendung von Gips bietet, einem natürlichen Material, das aus ökologischer und baubiologischer Sicht ideal ist, da es ungiftig, pH-neutral und nicht brennbar ist.

Die Produkte von Tecnico sind so konzipiert, dass sie sich in die zeitgenössische Wohnarchitektur einfügen und langlebig sind. Alle Tecnico-Produkte verwenden hocheffiziente Lichtquellen (integrierte LEDs oder LED-Glühbirnen), die daher eine große Lichtmenge bei geringem Verbrauch abgeben.

Infrarot-Analyse von Gips von Tecnico durch das Prüflabor Catas S.p.A.: die Analyse wurde mit der ATR-Technik durch direkten Kontakt des Produkts mit dem Sensorkristall durchgeführt. Das daraus resultierende Infrarotspektrum zeigt im Produktmaterial nur das Vorhandensein von Calciumsulfat-Dihydrat, das unter dem Namen Gips bekannt ist.

Materiales - Escayola

Las formas de Tecnico nacen de las infinitas posibilidades que brinda el uso de la escayola, un material natural, ideal desde el punto de vista ecológico y de la construcción ecológica ya que no es tóxico, tiene un pH neutro y no es combustible.

Los productos Tecnico están diseñados para integrarse con la arquitectura doméstica contemporánea y durar con el paso del tiempo. Todos los productos Tecnico utilizan fuentes luminosas (leds integrados o bombillas led) de alta eficiencia, que emiten una gran cantidad de luz con un consumo muy reducido.

Análisis técnico de infrarrojos sobre yesos por parte del laboratorio de ensayos Catas S.p.A.: el análisis se ha realizado con la técnica ATR por contacto directo del producto con el cristal del sensor. El espectro infrarrojo resultante muestra en la materia del producto únicamente la presencia de hemihidrato de sulfato de calcio conocido con el nombre común de yeso.

Материалы - Гипс

Разнообразные формы Tecnico рождаются из бесчисленных возможностей, открывающихся благодаря использованию гипса - натурального материала, идеального с точки зрения экологичности и «зеленого» строительства, поскольку он является нетоксичным, негорючим и имеет нейтральный pH.

Изделия Tecnico прекрасно вписываются в современные домашние интерьеры и характеризуются длительным сроком службы. Вся продукция Tecnico комплектуется высокоэффективными источниками света (встроенные светодиоды или светодиодные лампы), которые дают много света при невысоком потреблении электроэнергии.

Инфракрасный анализ гипсовых изделий Tecnico, проведенный испытательной лабораторией Catas S.p.A.: анализ проводился методом ИК-спектроскопии нарушенного полного внутреннего отражения, путем непосредственного контакта изделия с кристаллом датчика. Полученный инфракрасный спектр свидетельствует о том, что в веществе изделия содержится исключительно дигидрат сульфата кальция, известного как гипс.



Materiali - Alluminio

Core del brand Tecnico sono i prodotti in alluminio estruso. Naturalmente leggeri, durevoli in quanto resistenti e non soggetti a ossidazione, i prodotti in alluminio aumentano la loro sostenibilità grazie alla completa riciclabilità di questo materiale. Le coperture e le sorgenti LED ad alta efficienza possono essere facilmente disassemblate per riciclare separatamente i diversi materiali.

Materials - Aluminium

Tecnico's core are extruded aluminium products. Naturally light, long-lasting, sturdy and oxidation-resistant, aluminium products increase their sustainability thanks to their complete end-of-life recycling options. High efficiency covers and LED sources can be easily removed to sort the different materials for recycling purposes.

Materialien - Aluminium

Die Kernkomponente von Tecnico sind stranggepresste Aluminiumprodukte. Aluminiumprodukte sind von Natur aus leicht, langlebig, widerstandsfähig und oxidieren nicht. Dank der vollständigen Recyclebarkeit dieses Materials am Ende seiner Lebensdauer erhöhen sie die Nachhaltigkeit. Die Abdeckungen und die hocheffizienten LED-Leuchtmittel können leicht demontiert werden, um die verschiedenen Materialien getrennt zu recyceln.

Materiales - Aluminio

El alma de la marca Tecnico son los productos de aluminio extruido. Ligeros por naturaleza, duraderos gracias a su resistencia y no sometidos a oxidación, los productos de aluminio aumentan su sostenibilidad gracias a la completa capacidad de reciclaje de este material al final de su vida útil. Los recubrimientos y las fuentes led de alta eficiencia se pueden desmontar fácilmente para reciclar los diferentes materiales por separado.

Материалы - Алюминий

Центральное место в ассортименте продукции бренда Tecnico занимают изделия из экструдированного алюминия. Естественно легкие, долговечные и прочные, не подверженные окислению изделия из алюминия являются особо экологичными благодаря полному рециклингу этого материала по окончании эксплуатации изделия. Корпуса и высокоэффективные светодиодные источники света можно легко демонтировать и подвергнуть дифференцированной вторичной переработке.

TECNICO
NATURAL LIGHT

Designed by

**blank
design studio**



_blank design studio, fondato nel 2013 da Federico Elli e Stefano Filipuzzi, è uno studio di progettazione applicata alla produzione industriale e alla comunicazione. Docente a contratto presso il Politecnico di Milano, Federico Elli, si laurea in Disegno e Ingegnerizzazione del prodotto industriale presso lo stesso Ateneo ed affianca alla carriera didattica quella di industrial designer. Stefano Filipuzzi, Laureato in Disegno industriale presso il Politecnico di Milano, lavora da oltre dieci anni come art director e graphic designer occupandosi di visual design sia nel campo della stampa che in quello digitale.

_blank design studio collabora con realtà aziendali in settori differenti, ha ricevuto premi e riconoscimenti per la sua attività quali lo Sharp Design Contest e il Cristalplant Design Contest nel 2013, il premio speciale al Samsung Young Design Award nel 2014 ed è stato finalista al Young&Design nel 2015 con il progetto del tavolo Tombolo e nel 2109 con il progetto Linea per Sforzin Illuminazione per Urban Lighting premiato nel 2020 anche con il Good Design Award.

_blank design studio, established in 2013 by Federico Elli and Stefano Filipuzzi, is a design studio focused on industrial design and advertising. Federico Elli graduated in industrial design and engineering at the Politecnico di Milano and is now a lecturer at the same university. In addition to his teaching career, he is also a successful industrial designer. Stefano Filipuzzi graduated in industrial design at the Politecnico di Milano. He has acquired over ten years experience as an art director and graphic designer, specialising in visual design across both print and digital outputs.

_blank design studio works with businesses in various sectors and has received awards and accolades for its work, such as from the Sharp Design Contest and Cristalplant Design Contest in 2013, as well as the special award from the Samsung Young Design Award in 2014. The studio was also selected as a finalist in the 2015 Young&Design award for its design of the Tombolo table and in 2019 for the Sforzin Illuminazione Linea project for Urban Lighting, which also won the 2020 Good Design Award.

Beim 2013 von Federico Elli und Stefano Filipuzzi gegründeten **_blank design studio** handelt es sich um ein Planungsbüro, das in den Bereichen industrielle Produktion und Kommunikation tätig ist. Federico Elli hat an der Polytechnischen Universität Mailand Design und Engineering von Industrieprodukten studiert. Er hat an dieser Universität einen Lehrauftrag als Dozent inne und ist gleichzeitig als Industrial Designer tätig. Auch Stefano Filipuzzi hat Design und Engineering von Industrieprodukten an der Polytechnischen Universität Mailand studiert, arbeitet seit mehr als zehn Jahren als Artdirector und Graphic Designer und kümmert sich in den Bereichen Druck und Digital um die optische Gestaltung.

Das **_blank design studio** arbeitet mit Betrieben aus unterschiedlichen Branchen zusammen und hat für seine Tätigkeit Preise und Anerkennungen erhalten wie z.B. den Sharp Design Contest und den Cristalplant Design Contest im Jahr 2013, den Sonderpreis beim Samsung Young Design Award im Jahr 2014 und wurde beim Wettbewerb Young&Design 2015 mit dem Tischprojekt Tombolo Finalist und im Jahr 2109 mit dem Projekt Linea für die Firma Sforzin Illuminazione für Urban Lighting, das 2020 auch den Good Design Award erhielt.

_blank design studio, fundado en 2013 por Federico Elli y Stefano Filipuzzi, es un estudio de diseño enfocado a la producción industrial y a la comunicación. Profesor contratado en el Politécnico de Milán, Federico Elli, se licencia en Diseño e Ingeniería del producto industrial en dicha universidad y combina la carrera didáctica con aquella de diseñador industrial. Stefano Filipuzzi, licenciado en Diseño Industrial por el Politécnico de Milán, lleva más de diez años trabajando como art director y graphic designer, ocupándose de visual design tanto en el sector de la prensa como en el sector digital.

_blank design studio colabora con empresas que operan en diferentes sectores, ha recibido premios y reconocimientos por su actividad, como el Sharp Design Contest y el Cristalplant Design Contest en 2013, el premio especial Samsung Young Design Award en 2014 y fue finalista del Young&Design en 2015 con el proyecto de la mesa Tombolo y en 2109 con el proyecto Linea para Sforzin Illuminazione para Urban Lighting premiado también en 2020 con el Good Design Award.

_blank design studio, основанная в 2013 году Федерико Элли и Стефано Филипуцци, - это студия дизайна, работающая в сфере промышленного дизайна и коммуникации. Федерико Элли окончил факультет промышленного дизайна и инжиниринга в Политехническом институте Милана и в том же университете он сейчас преподает в качестве доцента, совмещая преподавательскую карьеру с деятельностью индустриального дизайнера. Стефано Филипуцци также окончил факультет промышленного дизайна в Политехническом институте Милана и более десяти лет работает художественным руководителем и графическим дизайнером в сфере визуального дизайна как в печатной, так и в цифровой областях.

Студия **_blank design studio** сотрудничает с компаниями в различных секторах и получила призы и награды за свою деятельность, такие как Конкурс дизайна Sharp и Конкурс дизайна Cristalplant в 2013 году, специальный приз на конкурсе Samsung Young Design Award в 2014 году, а также стала финалистом конкурса Young&Design в 2015 году с проектом стола Tombolo и в 2109 году - с проектом продукта Linea, который был разработан для Sforzin Illuminazione и вошел в каталог Urban Lighting; помимо этого, в 2020 году это изделие получило премию Good Design Award.

Designer

TECNICO
NATURAL LIGHT

Designed by

Acero
design studio

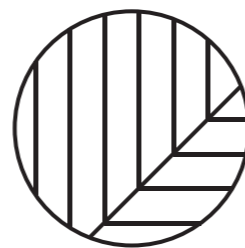

Acero.

Studio di design milanese specializzato nella progettazione di prodotti per il settore dell'illuminazione e dell'arredo. Mossa dalla passione per l'innovazione lo studio concepisce e disegna dal 2007 nuovi oggetti. Coniugando funzionalità ed estetica Acero sperimenta ed indaga forme, materiali e tecnologie.

Milanese design studio specialized in designing products for lighting and furniture industry. Driven by the passion for innovation, the studio has been imagining and designing new objects since 2007. By combining functionality and aesthetics, Acero experiments and investigates forms, materials and technologies.

Mailänder Designstudio, das auf die Gestaltung von Produkten für den Beleuchtungs- und Einrichtungssektor spezialisiert ist. Angetrieben von der Leidenschaft für Innovation konzipiert und entwirft das Studio seit 2007 neue Objekte. Acero verbindet Zweckmäßigkeit mit Ästhetik, ist experimentierfreudig und erforscht gern Formen, Materialien und Technologien.

Estudio milanés de diseño, especializado en proyecto de productos para el sector de la iluminación y la decoración. Desde 2007, impulsado por la pasión por la innovación, el Estudio idea y diseña nuevos objetos. Aunando funcionalidad y estética Acero experimenta e investiga formas, materiales y tecnologías.

Итальянская дизайн-студия, специализирующаяся на дизайне продукции для сферы освещения и интерьера. Движимая стремлением к инновациям, студия с 2007 года занимается разработкой и проектированием новых объектов. Комбинируя функциональность и эстетику, Acero создает и исследует формы, материалы и технологии.

Designer

TECNICO
NATURAL LIGHT

Designed by

**Luca
Artioli**

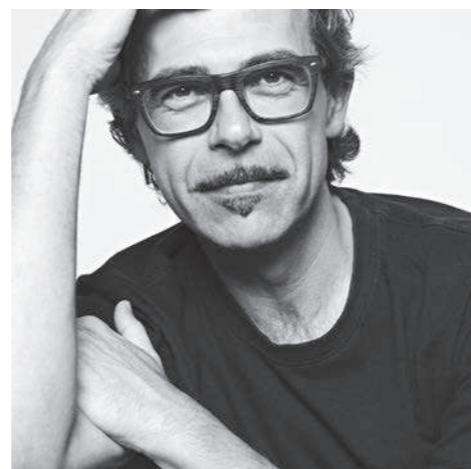

Nato nel 1967, dopo aver conseguito il diploma di Graphic Designer e Comunicazione Luca Artioli avvia la sua attività professionale come illustratore e creativo freelance presso studi di pubblicità. Nel 1994 è senior designer per la progettazione di accessori per l'abbigliamento, dove cura il design per l'accessorio e la grafica applicata al prodotto. Nel 1997 fonda lo Studio BEATBOX. Borse, oggettistica, grafica, sono alla base dell'attività di design dello Studio che collabora con importanti aziende italiane ed estere del settore, annoverando esperienze lavorative in Francia, Cina e Giappone. Dal 2013 prosegue la sua personale attività di consulenza per le aziende. Eleganza ed equilibrio sono gli elementi fondanti e i principi ispiratori del suo lavoro.

Borned in 1967, after graduating in Graphic Design and Communication Luca Artioli started his career as a freelance illustrator and creative designer at AD Agencies.

In 1994 he became senior designer in section Accessories for clothing, where he attended to accessory design and graphics applied to the product. In 1997 he founded Studio BEATBOX.

Bags, objects, graphics are the basis for Beatbox design works and the Studio collaborated with major Italian and foreign companies, including work experience in France, China and Japan. From 2013 he is going on with his personal consulting business for companies. Elegance and balance are the basic elements and inspiring principles of his work.

1967 geboren, beginnt Luca Artioli nach seinem Abschlusszeugnis in Graphic Design und Kommunikation seinen beruflichen Werdegang als Illustrator und kreativer Freiberufler in Werbeagenturen. 1994 ist er Senior Designer für den Entwurf von Bekleidungsaccessoires und kümmert sich um das Design des Accessoires und um die angewandte Produktgrafik. 1997 gründet er das Studio BEATBOX. Taschen, Alltagsgegenstände & Grafik sind die grundlegenden Tätigkeiten, mit denen sich das Studio beschäftigt, das mit be deutenden italienischen und ausländischen Firmen der Branche zusammenarbeitet und in Frankreich, China und Japan tätig ist.

Nace en 1967 y después de haber conseguido el diploma de Graphic Designer y Comunicación, Luca Artioli emprende su actividad profesional en estudios de publicidad como ilustrador y creativo freelance. En 1994 es Senior Designer para el proyecto de accesorios para el vestir, ocupándose del diseño del accesorio y del grafismo aplicado al producto. En 1997 crea el estudio BEATBOX. Bolsos, objetos, grafismo, son la base de las actividades de diseño del estudio, que colabora con destacadas empresas italianas y extranjeras del sector, contando con experiencias laborales en Francia, China y Japón. Desde 2013 prosigue su actividad personal de asesoramiento a las empresas. Elegancia y equilibrio son los elementos distintivos y los principios inspiradores de su trabajo.

Родился в 1967 году.

После получения диплома в области графического дизайна и коммуникации Лука Артиоли начинает свою профессиональную деятельность как фрилансер в качестве иллюстратора и креативного консультанта в рекламных студиях. В 1994 году он является старшим дизайнером по проектированию модных аксессуаров, занимающимся дизайном аксессуаров и графикой, приложенной к продукту. В 1997 году он основывает студию BEATBOX.









Сумки, различные предметы, графика являются основой дизайнерской деятельностью студии, которая сотрудничает с крупными итальянскими и зарубежными компаниями в этом секторе и накапливает опыт работы во Франции, Китае и Японии. С 2013 года он продолжает свою личную деятельность, предоставляя консультационные услуги компаниям. Элегантность и баланс являются основными элементами и руководящими принципами его работы.

Designer

INDICE PER TIPOLOGIA
 TABLE OF CONTENT BY TYPE
 INHALT NACH TYPLOGIE
 ÍNDICE POR TIPO
 СПИСОК ПО ТИПОЛОГИИ

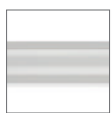



Estrusi LED

LED extruded range
 Stranggepresst mit LED
 Extrudidos LED
 Светодиодные экструдированные светильники

	Emathia Incasso White T133.W...	30 33
	Emathia Incasso Aluminium T133.AL...	30 33
	Eubea Incasso White T139.W...	34 37
	Eubea Incasso Aluminium T139.AL...	34 37
	Oropus Incasso White T221.W...	38 41
	Oropus Incasso Aluminium T221.AL...	38 41
	Eubea Esterno White T145.W...	42 45
	Eubea Esterno Aluminium T145.AL...	42 45
	Chalcis Esterno White T220.W...	46 49

Profili Lineari



Linear profiles
 Lineare Profile
 Perfiles lineales
 Линейные профили

	Pirgos T311.10 - T311.10 D	60 65
	Pirgos T311.11 - T311.11 D	60 65
	Pirgos T311.30 - T311.30 D	66 69
	Pirgos T311.31 - T311.31 D	66 69
	Pirgos T311.50	70 73

Incassi soffitto gesso

Recessed ceiling range in plaster
 Zum Einlassen an der Decke aus Gips
 Empotrados techo yeso
 Встраиваемые светильники
 для гипсокартонных потолков

	Attica T04	190 193
	Attica Glass T28	194 195
	Attica Orientabile T177	196 197
	Cadmea T32 - T51	200 201
	Doride T353	150 153
	Doride T354	154 157
	Filiatrá T337 - T338	76 87
	Filiatrá T381 - T382 - T383	88 103
	Heraea T255 - T256 - T257	158 169
	Lelanto T356 - T357	142 149
	Micene T01	198 199
	Nicia T22	188 189
	Olympia T232 - T233	170 173
	Olympia T235 - T236	174 177
	Phocis T384	104 107
	Polis T10	184 187
	Siris T165	178 181
	Sparta T93	182 183

	Thessaly T390 - T391 - T392 - T393	108 125
	Thessaly T332 - T334 - T335 - T336	126 141











Incassi parete gesso

Recessed wall range in plaster
 Zum Einlassen an der Wand aus Gips
 Empotrados pared yeso
 Встраиваемые светильники для
 гипсокартонных стен

	Sipario T76	204 205
---	-----------------------	------------

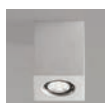









Gessi soffitto









Ceiling range in plaster
Gipslampen Decke
Yesos techo
Гипсовые потолочные светильники

	Anchise T371 - T372 - T373	326 341
	Arta T265 - T266	452 455
	Chio T262 - T263 - T264 - T274 - T278	350 359
	Cicladi T387 - T388 - T389	220 235
	Demetra T339 - T358 - T359	276 291
	Etide T258 - T259 - T260	428 433
	Esiodo Micro T179	448 449
	Heraea T193 - T194 - T271 - T273	434 441
	Lepreum T267 - T268 - T287 - T303	420 427
	Mylasa T294 - T295 - T296	408 413
	Pitane T401 - T402	252 263

Gessi parete











Wall range in plaster
Gipslampen Wand
Yesos pared
Гипсовые настенные светильники

	Anchise T374 - T375	342 349
	Arta T253 - T254	456 459
	Chio T319 - T320 - T321 - T322	360 379
	Cicladi T385 - T386 - T396	236 251
	Delfi T222 - T223 - T224	464 469
	Demetra T360 - T361	292 303
	Demetra T362	304 307
	Heraea T205 - T206 - T207	442 447
	Hermione T208 - T209 - T210	482 489
	Ionia T98	490 491
	Mantineia T106	494 495

	Opus T195	493 492
	Paro T269 - T270	460 463
	Patra T394 - T395	208 219
	Pellene T200 - T201	478 481
	Pitane T399 - T400	264 275
	Side T323 - T324 - T325 - T326	388 407
	Sibari T379 - T380	318 325
	Sicyon T203	450 451
	Teos T174.10 - T174.11 - T174.12	470 477



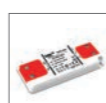

Alimentatori

Power supply units
Netzteile
Fuentes de alimentación
Блоки питания

































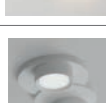

	Alimentatori 40W Dimmerabile T73.40W.24.DIM	31 47 35 51 39 55 43
	Alimentatori 100W Dimmerabile T73.100W.24.DIM	31 47 35 51 39 55 43
	Alimentatori 150W Dimmerabile T73.150W.24.DIM	31 47 35 51 39 55 43
	Alimentatori 240W Dimmerabile T73.240W.24.DIM	31 47 35 51 39 55 43
	Alimentatori 320W Dimmerabile T73.320w.24.DIM	31 47 35 51 39 55 43
	Alimentatori 50W SNAPPY T73.50W.24.SNP	31 47 35 51 39 55 43
	Alimentatori 100W SNAPPY T73.100W.24.SNP	31 47 35 51 39 55 43
	Alimentatori 150W SNAPPY T73.150W.24.SNP	31 47 35 51 39 55 43
	Alimentatori 200W SNAPPY T73.200W.24.SNP	31 47 35 51 39 55 43
	Alimentatori 320W SNAPPY T73.320W.24.SNP	31 47 35 51 39 55 43

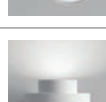
Led

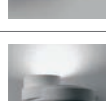

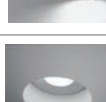















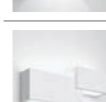

Led
Led
Led
Светодиод

	Strip Led 3000°K T397.1M.3000 T397.2M.3000 T397.3M.3000 T397.4M.3000 T397.5M.3000	31 47 35 51 39 55 43
	Strip Led 3000°K T398.1M.3000 T398.2M.3000 T398.3M.3000 T398.4M.3000 T398.5M.3000	31 47 35 51 39 55 43
	Strip Led 4000°K T397.1M.4000 T397.2M.4000 T397.3M.4000 T397.4M.4000 T397.5M.4000	31 47 35 51 39 55 43
	Strip Led 4000°K T398.1M.4000 T398.2M.4000 T398.3M.4000 T398.4M.4000 T398.5M.4000	31 47 35 51 39 55 43

INDICE ALFABETICO
 ALPHABETICAL TABLE OF CONTENTS
 ALPHABETISCHES VERZEICHNIS
 ÍNDICE ALFABÉTICO
 АЛФАВИТНЫЙ УКАЗАТЕЛЬ

	Anchise	T371 T374 T372 T375 T373	 p. 326	 p. 342
	Arta	T265 T253 T266 T254	 p. 452	 p. 456
	Attica	T04	 p. 190	
	Attica Glass	T28	 p. 194	
	Attica Orientabile	T177	 p. 196	
	Cadmea	T32 T51	 p. 200	
	Chalcis Esterno White Aluminium	T220.W... T220.AL...	 p. 46	
	Chio	T262 T319 T263 T320 T264 T321 T274 T322 T278	 p. 350	 p. 360
	Cycladi	T387 T385 T388 T386 T389 T396	 p. 220	 p. 236
	Delfi	T222 T223 T224	 p. 464	
	Demetra	T339 T358 T359	 p. 276	
	Demetra	T360 T361	 p. 292	
	Demetra	T362	 p. 304	
	Doride	T353	 p. 150	
	Doride	T354	 p. 154	

	Elide	T258 T259 T260	 p. 428	
	Emathia Incasso White Aluminium	T133.W... T133.AL...	 p. 30	
	Esiodo Micro	T179	 p. 448	
	Eubea Esterno White Aluminium	T145.W... T145.AL...	 p. 42	
	Eubea Incasso White Aluminium	T139.W... T139.AL...	 p. 34	
	Filiatrà	T337 T338	 p. 76	
	Filiatrà	T381 T382 T383	 p. 88	
	Heraea	T193 T194 T271 T273	 p. 434	
	Heraea	T205 T206 T207	 p. 442	
	Heraea	T255 T256 T257	 p. 158	
	Hermione	T208 T209 T210	 p. 482	
	Icus Esterno Aluminium	T310.W... T310.AL...	 p. 54	
	Ionia	T98	 p. 490	
	Lelanto	T356 T357	 p. 142	
	Lepreum	T267 T268 T287 T303	 p. 420	

	Mantineia	T106	 p. 494	
	Methoni Aluminium	T309.W... T309.AL...	 p. 50	
	Micene	T01	 p. 198	
	Mylasa	T294 T295 T296	 p. 408	
	Nicia	T22	 p. 188	
	Olympia	T232 T233	 p. 170	
	Olympia	T235 T236	 p. 174	
	Oropus Incasso White Aluminium	T221.W... T221.AL...	 p. 38	
	Opus	T195	 p. 493	
	Paro	T269 T270	 p. 460	
	Patra	T394 T395	 p. 208	
	Pellene	T200 T201	 p. 478	
	Phocis	T384	 p. 104	
	Pirgos	T311.10 T311.10 D T311.11 T311.11 D	 p. 60	
	Pirgos	T311.30 T311.30 D T311.31 T311.31 D	 p. 66	

	Pirgos	T311.50	 p. 70	
	Pitane	T399 T401 T400 T402	 p. 252	 p. 264
	Polis	T10	 p. 184	
	Sibari	T377 T379 T378 T380	 p. 308	 p. 318
	Side	T323 T291 T324 T292 T325 T293 T326	 p. 380	 p. 388
	Sipario	T76	 p. 204	
	Siris	T165	 p. 178	
	Sparta	T93	 p. 182	
	Sycion	T203	 p. 450	
	Teos	T174.10 T174.11 T174.12	 p. 470	
	Tenedos	T312 T313 T314	 p. 414	
	Thessaly	T390 T391 T392 T393	 p. 108	
	Thessaly	T332 T334 T335 T336	 p. 126	

INDICE PER CODICE
 TABLE OF CONTENTS BY CODE
 INHALT NACH ARTIKELNUMMER
 ÍNDICE POR REFERENCIA
 СПИСОК ПО КОДУ

T01	Micene	198	T207	Heraea	446	T310.AL...	Icus Esterno Aluminium	55	T380	Sibari	322
T01 C	Cassaforma	198	T208	Hermione	484	T311.10	Pirgos	62	T381	Filiatrà	92
T04	Attica	192	T209	Hermione	486	T311.10 D	Pirgos	62	T382	Filiatrà	96
T10	Polis	186	T210	Hermione	488	T311.11	Pirgos	62	T383	Filiatrà	100
T22	Nicia	188	T220.AL...	Chalcis Esterno Aluminium	47	T311.11 D	Pirgos	62	T384	Phocis	104
T28	Attica Glass	194	T220.W...	Chalcis Esterno White	47	T311.30	Pirgos	66	T385	Cicladi	240
T31 C	Cassaforma	200	T221.AL...	Oropus Incasso Aluminium	39	T311.30 D	Pirgos	66	T386	Cicladi	244
T32 2E27	Cadmea	200	T221.W...	Oropus Incasso White	39	T311.31	Pirgos	66	T387	Cicladi	224
T51 G24Q3-2X26W	Cadmea	200	T222	Delfi	466	T311.31 D	Pirgos	66	T388	Cicladi	228
T73.40W.24.DIM	Alimentatori 40W Dim.	31-35-39-43-47-51-55	T223	Delfi	467	T311.50	Pirgos	70	T389	Cicladi	232
T73.100W.24.DIM	Alimentatori 100W Dim.	31-35-39-43-47-51-55	T224	Delfi	468	T312	Tenedos	414	T390	Thessaly	110
T73.150W.24.DIM	Alimentatori 150W Dim.	31-35-39-43-47-51-55	T232	Olympia	170	T313	Tenedos	416	T391	Thessaly	114
T73.240W.24.DIM	Alimentatori 240W Dim.	31-35-39-43-47-51-55	T233	Olympia	172	T314	Tenedos	418	T392	Thessaly	118
T73.320W.24.DIM	Alimentatori 320W Dim.	31-35-39-43-47-51-55	T235	Olympia	174	T319	Chio	364	T393	Thessaly	122
T73.50W.24.SNP	Alimentatore 50W SNAPPY	31-35-39-43-47-51-55	T236	Olympia	176	T320	Chio	368	T394	Patra	212
T73.100W.24.SNP	Alimentatore 100W SNAPPY	31-35-39-43-47-51-55	T253	Arta	456	T321	Chio	372	T395	Patra	216
T73.150W.24.SNP	Alimentatore 150W SNAPPY	31-35-39-43-47-51-55	T254	Arta	458	T322	Chio	376	T396	Cicladi	248
T73.200W.24.SNP	Alimentatore 200W SNAPPY	31-35-39-43-47-51-55	T255	Heraea	158	T323	Side	392	T397.1M.3000	Strip Led 3000°K	31-35-39-43-47-51-55
T73.320W.24.SNP	Alimentatore 320W SNAPPY	31-35-39-43-47-51-55	T256	Heraea	162	T324	Side	396	T397.2M.3000	Strip Led 3000°K	31-35-39-43-47-51-55
T76	Sipario	204	T257	Heraea	166	T325	Side	400	T397.3M.3000	Strip Led 3000°K	31-35-39-43-47-51-55
T76 C	Cassaforma	204	T258	Elide	428	T326	Side	404	T397.4M.3000	Strip Led 3000°K	31-35-39-43-47-51-55
T93	Sparta	182	T259	Elide	430	T332	Thessaly	126	T397.5M.3000	Strip Led 3000°K	31-35-39-43-47-51-55
T98	Ionia	490	T260	Elide	432	T334	Thessaly	130	T397.1M.4000	Strip Led 4000°K	31-35-39-43-47-51-55
T106	Mantinea	494	T262	Chio	354	T335	Thessaly	134	T397.2M.4000	Strip Led 4000°K	31-35-39-43-47-51-55
T133	Taglio	31-35-39-43-47-51-55	T263	Chio	356	T336	Thessaly	138	T397.3M.4000	Strip Led 4000°K	31-35-39-43-47-51-55
T133.AL.....	Emathia Incasso Aluminium	31	T264	Chio	358	T337	Filiatrà	80	T397.4M.4000	Strip Led 4000°K	31-35-39-43-47-51-55
T133.W....	Emathia Incasso White	31	T265	Arta	452	T338	Filiatrà	84	T397.5M.4000	Strip Led 4000°K	31-35-39-43-47-51-55
T139.AL...	Eubea Incasso Aluminium	35	T266	Arta	454	T339	Demetra	280	T398.1M.3000	Strip Led 3000°K	31-35-39-43-47-51-55
T139.W...	Eubea Incasso White	35	T267	Lepreum	420	T353	Doride	150	T398.2M.3000	Strip Led 3000°K	31-35-39-43-47-51-55
T145.AL...	Eubea Esterno Aluminium	43	T268	Lepreum	422	T354	Doride	154	T398.3M.3000	Strip Led 3000°K	31-35-39-43-47-51-55
T145.W...	Eubea Esterno White	43	T269	Paro	460	T356	Lelanto	142	T398.4M.3000	Strip Led 3000°K	31-35-39-43-47-51-55
T165	Siris	180	T270	Paro	462	T357	Lelanto	146	T398.5M.3000	Strip Led 3000°K	31-35-39-43-47-51-55
T174.10	Teos	472	T271	Heraea	434	T358	Demetra	284	T398.1M.4000	Strip Led 4000°K	31-35-39-43-47-51-55
T174.11	Teos	474	T273	Heraea	436	T359	Demetra	288	T398.2M.4000	Strip Led 4000°K	31-35-39-43-47-51-55
T174.12	Teos	476	T274	Chio	350	T360	Demetra	296	T398.3M.4000	Strip Led 4000°K	31-35-39-43-47-51-55
T177	Attica Orientabile	196	T278	Chio	352	T361	Demetra	300	T398.4M.4000	Strip Led 4000°K	31-35-39-43-47-51-55
T179	Esiodo Micro	448	T287	Lepreum	424	T362	Demetra	304	T398.5M.4000	Strip Led 4000°K	31-35-39-43-47-51-55
T193	Heraea	438	T291	Side	382	T371	Anchise	330	T399	Pitane	268
T194	Heraea	440	T292	Side	384	T372	Anchise	334	T400	Pitane	272
T195	Opus	492	T293	Side	386	T373	Anchise	338	T401	Pitane	256
T200	Pellene	478	T294	Mylasa	408	T374	Anchise	342	T402	Pitane	260
T201	Pellene	480	T295	Mylasa	410	T375	Anchise	346			
T203	Sycion	450	T296	Mylasa	412	T377	Sibari	310			
T205	Heraea	442	T303	Lepreum	426	T378	Sibari	314			
T206	Heraea	444	T309.AL....	Methoni Aluminium	51	T379	Sibari	318			

INDICE PER DESIGNER

TABLE OF CONTENTS BY DESIGNER

INHALT NACH ARTIKELNUMMER

ÍNDICE POR REFERENCIA

СПИСОК ПО КОДУ

ACERO DESIGN STUDIO

Arta	T265 - T266 T253 - T254	452 456
Chio	T262 - T263 - T264 - T274 - T278 T319 - T320 - T321 - T322	350 360
Heraea	T193 - T194 - T271 - T273 T205 - T206 - 207 T255 - T256 - T257	434 442 158
Hermione	T208 - T209 - T210	482
Mylasa	T294 - T295 - T296	408
Lepreum	T267 - T268 - T287 - T303	420
Olympia	T232 - T233 T235 - T236	170 174
Paro	T269 - T270	460
Side	T323 - T 324 - T325 - T326 T291 - T292 - T293	388 380
Tenedos	T312 - T313 - T314	414
Teos	T174.10 - T174.11 - T174.12	470

ARTIOLI LUCA

Delfi	T222 - T223 - T224	464
Pellene	T200 - T201	478

_BLANK | DESIGN STUDIO

Anchise	T371 - T372 - T373 T374 - T375	326 342
Cicladi	T387 - T388 - T389 T385 - T386 - T396	220 236
Demetra	T339 - T358 - T359 T360 - T361 - T362	276 292
Elide	T258 - T259 - T260	428
Filiatrà	T337 - T338 T381 - T382 - T383	76 87
Patra	T394 - T395	208
Phocis	T384	104
Pitane	T399 - T400 soffitto T401 - T402 parete	252 264
Sibari	T377 - T378 soffitto T379 - T380 parete	308 325
Thessaly	T390 - T391 - T392 - T393	108

SFORZIN ILLUMINAZIONE

Attica	T04	190
Attica Glass	T28	194
Attica Orientabile	T177	196
Cadmea	T32 - T51	200
Chalcis Esterno Aluminium	T220.AL...	46
Chalcis Esterno White	T220.W...	46
Doride	T353 T354	150 154
Emathia Incasso Aluminium	T133.AL...	30
Emathia Incasso White	T133.W....	30
Esiodo Micro	T179	448
Eubea Esterno Aluminium	T145.AL...	42
Eubea Esterno White	T145.W...	42
Eubea Incasso Aluminium	T139.AL...	34
Eubea Incasso White	T139.W...	34
Ionia	T98	490
Icus Esterno Aluminium	T310.AL...	54
Lelanto	T356 - T357	142
Mantineia	T106	494

Methoni Esterno Aluminium	T309.AL...	50
Micene	T01	198
Nicia	T22	188
Opus	T195	492
Oropus Incasso Aluminium	T221.AL...	38
Oropus Incasso White	T221.W...	38
Pirgos	T311.10 - T311.10 D T311.11 - T311.11 D	60
Pirgos	T311.30 - T311.30 D T311.31 - T311.31 D	66
Pirgos	T311.50	70
Polis	T10	184
Siris	T165	178
Sparta	T93	182
Thessaly	T332 - T334 - T335 - T336	126

STUDIO 14

Sipario	T76	204
Sycion	T203	450

OMOLOGAZIONI E SIMBOLI
TYPE APPROVALS & SYMBOLS
ZULASSUNGEN & SYMBOLE
HOMOLOGACIONES Y SÍMBOLOS
ОМОЛОГАЦИИ И УСЛОВНЫЕ ОБОЗНАЧЕНИЯ



Apparato conforme alle Direttive della Comunità Europea
The appliance conforms to European Community Directives
Gerät ist konform mit den Richtlinien der Europäischen Gemeinschaft
Aparato conforme con las Directivas Comunitarias Europeas
Прибор соответствует требованиям Директив Европейского Сообщества



Apparato dotato di isolamento principale
The appliance is fitted with basic insulation
Gerät ist mit der Basisisolierung ausgestattet
Aparato dotado de aislamiento básico
Прибор снабжен главной изоляцией



Apparato idoneo per essere installato su superfici infiammabili
Suited for assembly on flammable surfaces
Geeignet für die montage auf entflammbaren oberflächen
Adecuado para montaje en superficies inflamables
Прибор годен для установки на пожароопасных поверхностях



Apparato dotato di doppio isolamento
The appliance is fitted with double insulation
Gerät ist mit zwei isolierungen ausgestattet
Aparato dotado de doble aislamiento
Прибор снабжен двойной изоляцией



Bassissima tensione
Very low voltage
Niedervolt
Muy baja tensión
низковольтные



IP2X = involucro protetto contro corpi solidi di dimensioni superiori a 12mm e contro l'accesso con un dito;
IPX0 = nessuna protezione contro l'acqua

IP2X = enclosure protected from solid objects greater than 12 mm in size and the insertion of fingers;
IPX0 = no water protection

IP2X = Gehäuse ist geschützt gegen feste Körper, die größer als 12 mm sind und gegen das Eindringen mit dem Finger;
IPX0 = kein Schutz gegen Wasser

IP2X = envolvente protegida contra cuerpos sólidos de tamaño superior a 12mm y que impide el acceso con un dedo;
IPX0 = ninguna protección contra el agua

IP2X = оболочка устройства защищена от попадания предметов, диаметр которых больше 12 мм, и от доступа пальцем;
IPX0 = нет защиты от проникновения внутрь корпуса воды



Portalampada adatto all'utilizzo di lampadine a led
Lamp holder suitable for use with LED bulbs
Lampenfassung für den Gebrauch von LED Lampen geeignet
Portálámpara idóneo para utilizar bombillas de LED
Ламповый патрон подходит для использования со светодиодными лампами



Apparecchio dotato di modulo led
Unit equipped with LED module
Gerät mit LED Modul
Aparato con módulo LED
Прибор снабжен светодиодным модулем



GRADI KELVIN - Unità di misura della temperatura di colore
KELVIN DEGREES - Unit of temperature measurement
GRAD KELVIN - Maßeinheit der Farbtemperatur
GRADOS KELVIN - Unidad de medida de la temperatura de color
ГРАДУСЫ КЕЛЬВИНА GRADI KELVIN – единица измерения цветовой температуры



CALDO - WARM
WARM - CALIENTE
ТЕПЛЫЙ СВЕТ

FREDDO - COLD
KALT - FRÍO
ХОЛОДНЫЙ СВЕТ

Lumen

Unità di misura del flusso luminoso
Unit of measurement of luminous flux
Maßeinheit des Lichtstroms
Unidad de medida del flujo luminoso
Единица измерения светового потока

mA

Intensità di corrente elettrica
The appliance is fitted with double insulation.
Intensität des elektrischen Stroms
Intensidad de corriente eléctrica
Сила электрического тока



DIRETTIVA 2002/96/CEE
L'obbligo di non smaltire i RAEE (rifiuti apparecchiature elettriche elettroniche) come rifiuto municipale misto ma effettuare una raccolta separata o consegnato al produttore

DIRECTIVE 2002/96/EC
Obligation not to dispose of WEEE (waste electrical electronic equipment) as mixed municipal waste, but arrange for it to be disposed of separately or returned to the supplier
RICHTLINIE 2002/96/EWG
Elektronikschrott, darf nicht mit dem Hausmüll entsorgt werden, sondern ist getrennt zu sammeln oder an den Hersteller zurückzugeben

DIRETTIVA 2002/96/CEE
Obligación de no eliminar los RAEE (Residuos de Aparatos Eléctricos y Electrónicos) como basura común sino efectuando una recogida selectiva o entregándolos al fabricante

ДИРЕКТИВА 2002/96/CEE
Отходы электрического и электронного оборудования должны обязательно утилизироваться отдельно от общих бытовых отходов или возвращаться производителю



Apparecchi non idonei ad essere ricoperti di materiale termicamente isolante
Equipment that should not be covered with heat insulating material
Die Geräte sind nicht dazu geeignet, mit einem thermisch isolierenden Material bedeckt zu werden
Aparatos no idóneos para ser tapados con material térmicamente aislante
Устройства не пригодны для покрытия теплоизоляционным материалом



TECNICO[®]
N A T U R A L L I G H T



ESTRUSI EXTRUDED LIGHTS

Naturalmente leggeri e durevoli i prodotti in alluminio estruso a marchio Tecnico vengono proposti nelle finiture alluminio anodizzato naturale o verniciato bianco con copertura opale o satinata. Sono disponibili in diverse lunghezze e viene proposto un servizio di taglio su misura in base al progetto così come sono abbinabili a differenti sorgenti luminose led.

Naturally light and long-lasting, Tecnico's extruded aluminium products are available in natural anodized or white painted aluminium finishes, with opal or satin cover. They are available in different lengths, with a cut-to-size service based on the project, and they can be paired with different LED lighting sources.

Die stranggepressten Aluminiumprodukte von Tecnico, die von Natur aus leicht und langlebig sind, sind in natur eloxiertem oder weiß lackiertem Aluminium mit einer opalen oder satinierten Oberfläche erhältlich. Sie sind in verschiedenen Längen erhältlich und können je nach Projekt zugeschnitten sowie mit verschiedenen LED-Lichtquellen kombiniert werden.

Ligeros por naturaleza y duraderos, los productos de aluminio extruido de la marca Tecnico se ofrecen en acabados de aluminio anodizado natural o pintado de blanco con recubrimiento opalino o satinado. Están disponibles en diferentes longitudes y se ofrece un servicio de corte a medida en función del proyecto. También se pueden combinar con diferentes fuentes de luz led.

Натурально легкие и долговечные изделия из экструдированного алюминия бренда Tecnico предлагаются с следующими отделками: натуральный анодированный алюминий или покрытие белой краской с матовым или сатиновым финишем. Имеются различные варианты длины; предлагаются услуги резки по индивидуальному размеру в зависимости от проекта и сочетания с различными светодиодными источниками света.

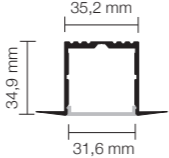
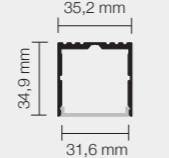
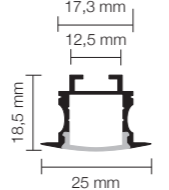
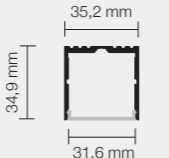
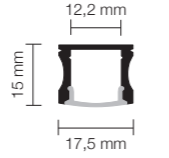
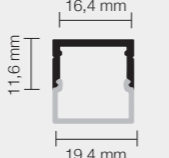
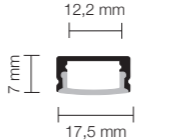
NOME PRODOTTO Product name / Produktname / Nombre del producto / Наименование изделия	PAG Page / Seite / Páġ. / Стр.	MISURE Measurements / Abmessungen / Medidas / Размеры	PROFILO Profile / Profil / Perfil / Профиль	COPERTURA Cover / Abdeckung / Recubrimiento / Покрытие	LED LED source / LED-Lichtquelle / Fuente de led / Светодиодный источник света					
					T397...		T398...			
		mm	WHITE	ALUMINIUM	SAT	OPAL	14,4 Watt/m 3.000 K° Ra80 2016 lumen/m 160 led/m 24V	14,4 Watt/m 4.000 K° Ra80 2232 lumen/m 160 led/m 24V	19,2 Watt/m 3.000 K° Ra90 2400 lumen/m 240 led/m 24V	19,2 Watt/m 4.000 K° Ra90 2640 lumen/m 240 led/m 24V
Emathia Incasso T133...	31		X	X	X	X	X	X	X	
Eubea Incasso T139...	35		X	X	X	X	X	X	X	
Oropus Incasso T221...	39		X	X	X	NO	X	X	X	
Eubea Esterno T145...	43		X	X	X	X	X	X	X	
Chalcis Esterno T220...	47		X	X	X	NO	X	X	X	
Methoni Esterno T309...	51		NO	X	NO	X	X	X	X	
Icus Esterno T310...	55		NO	X	NO	X	X	X	X	



EMATHIA INCASSO

Il sistema è in estruso di alluminio o alluminio verniciato bianco e la copertura in plastica bianca opale (Opal) o satinata (Sat). Alimentatori obbligatori.

The system is made of white coated extruded aluminium with an Opal (Opal) or Satin (Sat) white plastic cover. Compulsory power supply units.

Das System besteht aus stranggepresstem Aluminium und ist weiß lackiert, die Abdeckung ist aus weißem Kunststoff, opalweiß (Opal) oder satiniert (Sat). Netzteile sind Pflicht.

El sistema es de extrudido de aluminio pintado blanco y el recubrimiento de plástico blanco opalino (Opal) o satinado (Sat). Fuentes de alimentación obligatorias.

Система изготовлена из экструдированного алюминия, окрашенного в белый цвет; покрытие из пластика белого-молочного цвета (Opal) или белого матового цвета (Sat). Блоки питания обязательны.

EMATHIA INCASSO WHITE	cm	COPERTURA Cover / Abdeckung / Cobertura / Покрытие	EMATHIA INCASSO ALUMINIUM	cm	COPERTURA Cover / Abdeckung / Cobertura / Покрытие
T133.W.50.OPAL	50	Opal	T133.AL.50.OPAL	50	Opal
T133.W.50.SAT	50	Sat	T133.AL.50.SAT	50	Sat
T133.W.100.OPAL	100	Opal	T133.AL.100.OPAL	100	Opal
T133.W.100.SAT	100	Sat	T133.AL.100.SAT	100	Sat
T133.W.150.OPAL	150	Opal	T133.AL.150.OPAL	150	Opal
T133.W.150.SAT	150	Sat	T133.AL.150.SAT	150	Sat
T133.W.200.OPAL	200	Opal	T133.AL.200.OPAL	200	Opal
T133.W.200.SAT	200	Sat	T133.AL.200.SAT	200	Sat

T133.TAGLIO Servizio di taglio del profilo secondo disegno fornito / Profile cut-to-size service, according to the drawing provided / Profilschnitt nach gelieferter Zeichnung / Servicio de corte del perfil según el diseño proporcionado / Услуги резки профиля на основании предоставленного чертежа

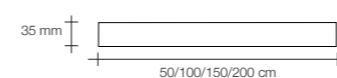



Misure per incasso / Whole dimensions / Einbaumaße / Medidas del empotrable / Встраиваемый размер

LED	Strip Led 3000°K	cm	Strip Led 4000°K	cm
 Strip 240 led/m	T397.1M.3000	100 cm	T397.1M.4000	100 cm
	T397.2M.3000	200 cm	T397.2M.4000	200 cm
	T397.3M.3000	300 cm	T397.3M.4000	300 cm
	T397.4M.3000	400 cm	T397.4M.4000	400 cm
	T397.5M.3000	500 cm	T397.5M.4000	500 cm
	T398.1M.3000	100 cm	T398.1M.4000	100 cm
	T398.2M.3000	200 cm	T398.2M.4000	200 cm
	T398.3M.3000	300 cm	T398.3M.4000	300 cm
	T398.4M.3000	400 cm	T398.4M.4000	400 cm
	T398.5M.3000	500 cm	T398.5M.4000	500 cm

ALIMENTATORI

Power supply units - Netzgeräte - Fuentes de alimentación - Блоки питания

L x H x W mm

	T73.40W.24.DIM	171x30x40 mm
	T73.100W.24.DIM	220x30x40 mm
	T73.150W.24.DIM	220x40x50 mm
	T73.240W.24.DIM	244x40x50 mm
	T73.320W.24.DIM	255x40x50 mm
	T73.50W.24.SNP	160x58x18 mm
	T73.100W.24.SNP	164x56x17 mm
	T73.150W.24.SNP	179x63x30 mm
	T73.200W.24.SNP	195x67x31 mm
	T73.320W.24.SNP	215x77x35 mm





EUBEA INCASSO

Il sistema è in estruso di alluminio o alluminio verniciato bianco e la copertura in plastica bianca opale (Opal) o satinata (Sat). Alimentatori obbligatori.

The system is made of white coated extruded aluminium with an Opal (Opal) or Satin (Sat) white plastic cover. Compulsory power supply units.

Das System besteht aus stranggepresstem Aluminium und ist weiß lackiert, die Abdeckung ist aus weißem Kunststoff, opalweiß (Opal) oder satiniert (Sat). Netzteile sind Pflicht.

El sistema es de extrudido de aluminio pintado blanco y el recubrimiento de plástico blanco opalino (Opal) o satinado (Sat). Fuentes de alimentación obligatorias.

Система изготовлена из экструдированного алюминия, окрашенного в белый цвет; покрытие из пластика белого-молочного цвета (Opal) или белого матового цвета (Sat). Блоки питания обязательны.

EUBEA INCASSO WHITE	cm	COPERTURA Cover / Abdeckung / Cobertura / Покрытие	EUBEA INCASSO ALUMINIUM	cm	COPERTURA Cover / Abdeckung / Cobertura / Покрытие
T139.W.50.OPAL	50	Opal	T139.AL.50.OPAL	50	Opal
T139.W.50.SAT	50	Sat	T139.AL.50.SAT	50	Sat
T139.W.100.OPAL	100	Opal	T139.AL.100.OPAL	100	Opal
T139.W.100.SAT	100	Sat	T139.AL.100.SAT	100	Sat
T139.W.150.OPAL	150	Opal	T139.AL.150.OPAL	150	Opal
T139.W.150.SAT	150	Sat	T139.AL.150.SAT	150	Sat
T139.W.200.OPAL	200	Opal	T139.AL.200.OPAL	200	Opal
T139.W.200.SAT	200	Sat	T139.AL.200.SAT	200	Sat

T133.TAGLIO Servizio di taglio del profilo secondo disegno fornito / Profile cut-to-size service, according to the drawing provided / Profilschnitt nach gelieferter Zeichnung / Servicio de corte del perfil según el diseño proporcionado / Услуги резки профиля на основании предоставленного чертежа

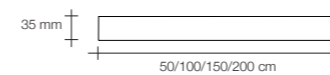



Misure per incasso / Whole dimensions / Einbauch Maße / Medidas del empotrable / Встраиваемый размер

LED	Strip Led 3000°K	cm	Strip Led 4000°K	cm
 <p>Strip 240 led/m</p>	T397.1M.3000	100 cm	T397.1M.4000	100 cm
	T397.2M.3000	200 cm	T397.2M.4000	200 cm
	T397.3M.3000	300 cm	T397.3M.4000	300 cm
	T397.4M.3000	400 cm	T397.4M.4000	400 cm
	T397.5M.3000	500 cm	T397.5M.4000	500 cm
	T398.1M.3000	100 cm	T398.1M.4000	100 cm
	T398.2M.3000	200 cm	T398.2M.4000	200 cm
	T398.3M.3000	300 cm	T398.3M.4000	300 cm
	T398.4M.3000	400 cm	T398.4M.4000	400 cm
	T398.5M.3000	500 cm	T398.5M.4000	500 cm

ALIMENTATORI

Power supply units - Netzgeräte - Fuentes de alimentación - Блоки питания

L x H x W mm

	T73.40W.24.DIM	171x30x40 mm
	T73.100W.24.DIM	220x30x40 mm
	T73.150W.24.DIM	220x40x50 mm
	T73.240W.24.DIM	244x40x50 mm
	T73.320W.24.DIM	255x40x50 mm
	T73.50W.24.SNP	160x58x18 mm
	T73.100W.24.SNP	164x56x17 mm
	T73.150W.24.SNP	179x63x30 mm
	T73.200W.24.SNP	195x67x31 mm
	T73.320W.24.SNP	215x77x35 mm





OROPUS INCASSO

Il sistema è in estruso di alluminio o alluminio verniciato bianco e la copertura in plastica bianca opale (Opal) o satinata (Sat). A soffitto o parete. Alimentatori obbligatori.
 The system is made of white coated extruded aluminium with an Opal (Opal) or Satin (Sat) white plastic cover. Ceiling or wall mounting. Compulsory power supply units.
 Das System besteht aus stranggepresstem Aluminium und ist weiß lackiert, die Abdeckung ist aus weißem Kunststoff, opalweiß (Opal) oder satiniert (Sat). Für Decke oder Wand. Netzteile erforderlich.

El sistema es de extrudido de aluminio pintado blanco y el recubrimiento de plástico blanco opalino (Opal) o satinado (Sat). De techo o de pared. Fuentes de alimentación obligatorias.

Система изготовлена из экструдированного алюминия, окрашенного в белый цвет; покрытие из пластика молочно-белого цвета (Opal) или белого матового цвета (Sat). Потолочное или настенное крепление. Блоки питания обязательны.

OROPUS INCASSO WHITE	cm	COPERTURA Cover / Abdeckung / Coertura / Покрытие	OROPUS INCASSO ALUMINIUM	cm	COPERTURA Cover / Abdeckung / Coertura / Покрытие
T221.W.50.SAT	50	Sat	T221.AL.50.SAT	50	Sat
T221.W.100.SAT	100	Sat	T221.AL.100.SAT	100	Sat
T221.W.150.SAT	150	Sat	T221.AL.150.SAT	150	Sat
T221.W.200.SAT	200	Sat	T221.AL.200.SAT	200	Sat

T133.TAGLIO Servizio di taglio del profilo secondo disegno fornito / Profile cut-to-size service, according to the drawing provided / Profilschnitt nach gelieferter Zeichnung / Servicio de corte del perfil según el diseño proporcionado / Услуги резки профиля на основании предоставленного чертежа

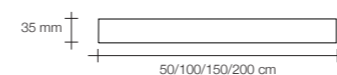

Misure per incasso / Whole dimensions / Einbaumaße / Medidas del empotrable / Встраиваемый размер

LED	Strip Led 3000°K	cm	Strip Led 4000°K	cm
<p>Strip 240 led/m</p>	T397.1M.3000	100 cm	T397.1M.4000	100 cm
	T397.2M.3000	200 cm	T397.2M.4000	200 cm
	T397.3M.3000	300 cm	T397.3M.4000	300 cm
	T397.4M.3000	400 cm	T397.4M.4000	400 cm
	T397.5M.3000	500 cm	T397.5M.4000	500 cm
	T398.1M.3000	100 cm	T398.1M.4000	100 cm
	T398.2M.3000	200 cm	T398.2M.4000	200 cm
	T398.3M.3000	300 cm	T398.3M.4000	300 cm
	T398.4M.3000	400 cm	T398.4M.4000	400 cm
	T398.5M.3000	500 cm	T398.5M.4000	500 cm

ALIMENTATORI

Power supply units - Netzgeräte - Fuentes de alimentación - Блоки питания

L x H x W mm

	T73.40W.24.DIM	171x30x40 mm
	T73.100W.24.DIM	220x30x40 mm
	T73.150W.24.DIM	220x40x50 mm
	T73.240W.24.DIM	244x40x50 mm
	T73.320W.24.DIM	255x40x50 mm
	T73.50W.24.SNP	160x58x18 mm
	T73.100W.24.SNP	164x56x17 mm
	T73.150W.24.SNP	179x63x30 mm
	T73.200W.24.SNP	195x67x31 mm
	T73.320W.24.SNP	215x77x35 mm





EUBEA ESTERNO

Il sistema, installabile a soffitto o parete, è in estruso di alluminio o alluminio verniciato bianco con copertura in plastica bianca opale(Opal) o satinata (Sat). Alimentatori obbligatori.

The system – which can be installed on the ceiling or wall – is made of white coated extruded aluminium with an Opal (Opal) or Satin (Sat) white plastic cover. Compulsory power supply units.

Das System, das auf Decken oder Wände installiert werden kann, besteht aus stranggepresstem Aluminium und ist weiß lackiert, die Abdeckung ist aus weißem Kunststoff, opalweiß (Opal) oder satiniert (Sat). Netzteile erforderlich.

El sistema, que puede instalarse en el techo o la pared, es de extrudido de aluminio pintado blanco y el recubrimiento de plástico blanco opalino (Opal) o satinado (Sat). Fuentes de alimentación obligatorias.

Система для потолочного или настенного монтажа изготовлена из экструдированного алюминия, окрашенного в белый цвет; покрытие из пластика молочно-белого цвета (Opal) или белого матового цвета (Sat). Блоки питания обязательны.

EUBEA ESTERNO WHITE	cm	COPERTURA Cover / Abdeckung / Cobertura / Покрытие	EUBEA ESTERNO ALUMINIUM	cm	COPERTURA Cover / Abdeckung / Cobertura / Покрытие
T145.W.50.OPAL	50	Opal	T145.AL.50.OPAL	50	Opal
T145.W.50.SAT	50	Sat	T145.AL.50.SAT	50	Sat
T145.W.100.OPAL	100	Opal	T145.AL.100.OPAL	100	Opal
T145.W.100.SAT	100	Sat	T145.AL.100.SAT	100	Sat
T145.W.150.OPAL	150	Opal	T145.AL.150.OPAL	150	Opal
T145.W.150.SAT	150	Sat	T145.AL.150.SAT	150	Sat
T145.W.200.OPAL	200	Opal	T145.AL.200.OPAL	200	Opal
T145.W.200.SAT	200	Sat	T145.AL.200.SAT	200	Sat

T133.TAGLIO Servizio di taglio del profilo secondo disegno fornito / Profile cut-to-size service, according to the drawing provided / Profilschnitt nach gelieferter Zeichnung / Servicio de corte del perfil según el diseño proporcionado / Услуги резки профиля на основании предоставленного чертежа

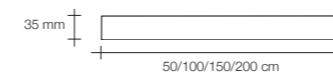

Misure per incasso / Whole dimensions / Einbauch Maße / Medidas del empotrable / Встраиваемый размер

LED	Strip Led 3000°K	cm	Strip Led 4000°K	cm
<p>Strip 240 led/m</p>	T397.1M.3000	100 cm	T397.1M.4000	100 cm
	T397.2M.3000	200 cm	T397.2M.4000	200 cm
	T397.3M.3000	300 cm	T397.3M.4000	300 cm
	T397.4M.3000	400 cm	T397.4M.4000	400 cm
	T397.5M.3000	500 cm	T397.5M.4000	500 cm
	T398.1M.3000	100 cm	T398.1M.4000	100 cm
	T398.2M.3000	200 cm	T398.2M.4000	200 cm
	T398.3M.3000	300 cm	T398.3M.4000	300 cm
	T398.4M.3000	400 cm	T398.4M.4000	400 cm
	T398.5M.3000	500 cm	T398.5M.4000	500 cm

ALIMENTATORI

Power supply units - Netzgeräte - Fuentes de alimentación - Блоки питания

L x H x W mm



T73.40W.24.DIM	171x30x40 mm
T73.100W.24.DIM	220x30x40 mm
T73.150W.24.DIM	220x40x50 mm
T73.240W.24.DIM	244x40x50 mm
T73.320W.24.DIM	255x40x50 mm



T73.50W.24.SNP	160x58x18 mm
T73.100W.24.SNP	164x56x17 mm
T73.150W.24.SNP	179x63x30 mm
T73.200W.24.SNP	195x67x31 mm
T73.320W.24.SNP	215x77x35 mm





CHALCIS ESTERNO

Il sistema, installabile a soffitto o parete, è in estruso di alluminio o alluminio verniciato bianco con copertura in plastica bianca opale (Opal) o satinata (Sat). Alimentatori obbligatori.

The system - which can be installed on the ceiling or wall - is made of white coated extruded aluminium with an Opal (Opal) or Satin (Sat) white plastic cover. Compulsory power supply units.

Das System, das auf Decken oder Wände installiert werden kann, besteht aus stranggepresstem Aluminium und ist weiß lackiert, die Abdeckung ist aus weißem Kunststoff, opalweiß (Opal) oder satiniert (Sat). Netzteile erforderlich.

El sistema, que puede instalarse en el techo o la pared, es de extrudido de aluminio pintado blanco y el recubrimiento de plástico blanco opalino (Opal) o satinado (Sat). Fuentes de alimentación obligatorias.

Система для потолочного или настенного монтажа изготовлена из экструдированного алюминия, окрашенного в белый цвет; покрытие из пластика молочно-белого цвета (Opal) или белого матового цвета (Sat). Блоки питания обязательны.

CHALCIS ESTERNO WHITE	cm	COPERTURA Cover / Abdeckung / Cobertura / Покрытие	<input type="checkbox"/>	CHALCIS ESTERNO ALUMINIUM	cm	COPERTURA Cover / Abdeckung / Cobertura / Покрытие	<input type="checkbox"/>
T220.W.50.SAT	50	Sat	<input type="checkbox"/>	T220.AL.50.SAT	50	Sat	<input type="checkbox"/>
T220.W.100.SAT	100	Sat	<input type="checkbox"/>	T220.AL.100.SAT	100	Sat	<input type="checkbox"/>
T220.W.150.SAT	150	Sat	<input type="checkbox"/>	T220.AL.150.SAT	150	Sat	<input type="checkbox"/>
T220.W.200.SAT	200	Sat	<input type="checkbox"/>	T220.AL.200.SAT	200	Sat	<input type="checkbox"/>

T133.TAGLIO Servizio di taglio del profilo secondo disegno fornito / Profile cut-to-size service, according to the drawing provided / Profilschnitt nach gelieferter Zeichnung / Servicio de corte del perfil según el diseño proporcionado / Услуги резки профиля на основании предоставленного чертежа

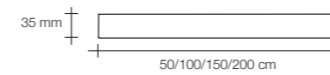

Misure per incasso / Whole dimensions / Einbaumaße / Medidas del empotrable / Встраиваемый размер

LED	Strip Led 3000°K	cm	Strip Led 4000°K	cm
<p>Strip 240 led/m</p>	T397.1M.3000	100 cm	T397.1M.4000	100 cm
	T397.2M.3000	200 cm	T397.2M.4000	200 cm
	T397.3M.3000	300 cm	T397.3M.4000	300 cm
	T397.4M.3000	400 cm	T397.4M.4000	400 cm
	T397.5M.3000	500 cm	T397.5M.4000	500 cm
	T398.1M.3000	100 cm	T398.1M.4000	100 cm
	T398.2M.3000	200 cm	T398.2M.4000	200 cm
	T398.3M.3000	300 cm	T398.3M.4000	300 cm
	T398.4M.3000	400 cm	T398.4M.4000	400 cm
	T398.5M.3000	500 cm	T398.5M.4000	500 cm

ALIMENTATORI

Power supply units - Netzgeräte - Fuentes de alimentación - Блоки питания

L x H x W mm



T73.40W.24.DIM	171x30x40 mm
T73.100W.24.DIM	220x30x40 mm
T73.150W.24.DIM	220x40x50 mm
T73.240W.24.DIM	244x40x50 mm
T73.320W.24.DIM	255x40x50 mm



T73.50W.24.SNP	160x58x18 mm
T73.100W.24.SNP	164x56x17 mm
T73.150W.24.SNP	179x63x30 mm
T73.200W.24.SNP	195x67x31 mm
T73.320W.24.SNP	215x77x35 mm





METHONI ESTERNO

Il sistema, installabile a soffitto o parete, è in estruso di alluminio o alluminio verniciato bianco con copertura in plastica bianca opale (Opal) o satinata (Sat). Alimentatori obbligatori.

The system - which can be installed on the ceiling or wall - is made of white coated extruded aluminium with an Opal (Opal) or Satin (Sat) white plastic cover. Compulsory power supply units.

Das System, das auf Decken oder Wände installiert werden kann, besteht aus stranggepresstem Aluminium und ist weiß lackiert, die Abdeckung ist aus weißem Kunststoff, opalweiß (Opal) oder satiniert (Sat). Netzteile erforderlich.

El sistema, que puede instalarse en el techo o la pared, es de extrudido de aluminio pintado blanco y el recubrimiento de plástico blanco opalino (Opal) o satinado (Sat). Fuentes de alimentación obligatorias.

Система для потолочного или настенного монтажа изготовлена из экструдированного алюминия, окрашенного в белый цвет; покрытие из пластика молочно-белого цвета (Opal) или белого матового цвета (Sat). Блоки питания обязательны.

METHONI ESTERNO ALUMINIUM

	cm	COPERTURA Cover / Abdeckung / Cobertura / Покрытие	
T309.AL.50.OPAL	50	Opal	<input type="checkbox"/>
T309.AL.100.OPAL	100	Opal	<input type="checkbox"/>
T309.AL.150.OPAL	150	Opal	<input type="checkbox"/>
T309.AL.200.OPAL	200	Opal	<input type="checkbox"/>

T133.TAGLIO Servizio di taglio del profilo secondo disegno fornito / Profile cut-to-size service, according to the drawing provided / Profilschnitt nach gelieferter Zeichnung / Servicio de corte del perfil según el diseño proporcionado / Услуги резки профиля на основании предоставленного чертежа

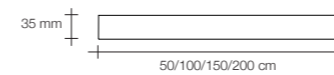

Misure per incasso / Whole dimensions / Einbaumaße / Medidas del empotrable / Встраиваемый размер

LED

	Strip Led 3000°K	cm	Strip Led 4000°K	cm
 Strip 240 led/m	T397.1M.3000	100 cm	T397.1M.4000	100 cm
	T397.2M.3000	200 cm	T397.2M.4000	200 cm
	T397.3M.3000	300 cm	T397.3M.4000	300 cm
	T397.4M.3000	400 cm	T397.4M.4000	400 cm
	T397.5M.3000	500 cm	T397.5M.4000	500 cm
	T398.1M.3000	100 cm	T398.1M.4000	100 cm
	T398.2M.3000	200 cm	T398.2M.4000	200 cm
	T398.3M.3000	300 cm	T398.3M.4000	300 cm
	T398.4M.3000	400 cm	T398.4M.4000	400 cm
	T398.5M.3000	500 cm	T398.5M.4000	500 cm

ALIMENTATORI

Power supply units - Netzgeräte - Fuentes de alimentación - Блоки питания

L x H x W mm



T73.40W.24.DIM	171x30x40 mm
T73.100W.24.DIM	220x30x40 mm
T73.150W.24.DIM	220x40x50 mm
T73.240W.24.DIM	244x40x50 mm
T73.320W.24.DIM	255x40x50 mm



T73.50W.24.SNP	160x58x18 mm
T73.100W.24.SNP	164x56x17 mm
T73.150W.24.SNP	179x63x30 mm
T73.200W.24.SNP	195x67x31 mm
T73.320W.24.SNP	215x77x35 mm





ICUS ESTERNO

Il sistema, installabile a soffitto o parete, è in estruso di alluminio o alluminio verniciato bianco con copertura in plastica bianca opale(Opal) o satinata (Sat). Alimentatori obbligatori.

The system - which can be installed on the ceiling or wall - is made of white coated extruded aluminium with an Opal (Opal) or Satin (Sat) white plastic cover. Compulsory power supply units.

Das System, das auf Decken oder Wände installiert werden kann, besteht aus stranggepresstem Aluminium und ist weiß lackiert, die Abdeckung ist aus weißem Kunststoff, opalweiß (Opal) oder satiniert (Sat). Netzteile erforderlich.

El sistema, que puede instalarse en el techo o la pared, es de extrudido de aluminio pintado blanco y el recubrimiento de plástico blanco opalino (Opal) o satinado (Sat). Fuentes de alimentación obligatorias.

Система для потолочного или настенного монтажа изготовлена из экструдированного алюминия, окрашенного в белый цвет; покрытие из пластика молочно-белого цвета (Opal) или белого матового цвета (Sat). Блоки питания обязательны.

ICUS ESTERNO ALUMINIUM

	cm	COPERTURA Cover / Abdeckung / Cobertura / Покрытие	
T310.AL.50.OPAL	50	Opal	<input type="checkbox"/>
T310.AL.100.OPAL	100	Opal	<input type="checkbox"/>
T310.AL.150.OPAL	150	Opal	<input type="checkbox"/>
T310.AL.200.OPAL	200	Opal	<input type="checkbox"/>

T133.TAGLIO Servizio di taglio del profilo secondo disegno fornito / Profile cut-to-size service, according to the drawing provided / Profilschnitt nach gelieferter Zeichnung / Servicio de corte del perfil según el diseño proporcionado / Услуги резки профиля на основании предоставленного чертежа

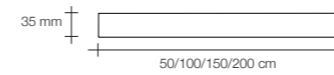

Misure per incasso / Whole dimensions / Einbauch Maße / Medidas del empotrable / Встраиваемый размер

LED

Strip Led 3000°K	cm	Strip Led 4000°K	cm
T397.1M.3000	100 cm	T397.1M.4000	100 cm
T397.2M.3000	200 cm	T397.2M.4000	200 cm
T397.3M.3000	300 cm	T397.3M.4000	300 cm
T397.4M.3000	400 cm	T397.4M.4000	400 cm
T397.5M.3000	500 cm	T397.5M.4000	500 cm
T398.1M.3000	100 cm	T398.1M.4000	100 cm
T398.2M.3000	200 cm	T398.2M.4000	200 cm
T398.3M.3000	300 cm	T398.3M.4000	300 cm
T398.4M.3000	400 cm	T398.4M.4000	400 cm
T398.5M.3000	500 cm	T398.5M.4000	500 cm



Strip 240 led/m

ALIMENTATORI

Power supply units - Netzgeräte - Fuentes de alimentación - Блоки питания

L x H x W mm



T73.40W.24.DIM	171x30x40 mm
T73.100W.24.DIM	220x30x40 mm
T73.150W.24.DIM	220x40x50 mm
T73.240W.24.DIM	244x40x50 mm
T73.320W.24.DIM	255x40x50 mm



T73.50W.24.SNP	160x58x18 mm
T73.100W.24.SNP	164x56x17 mm
T73.150W.24.SNP	179x63x30 mm
T73.200W.24.SNP	195x67x31 mm
T73.320W.24.SNP	215x77x35 mm



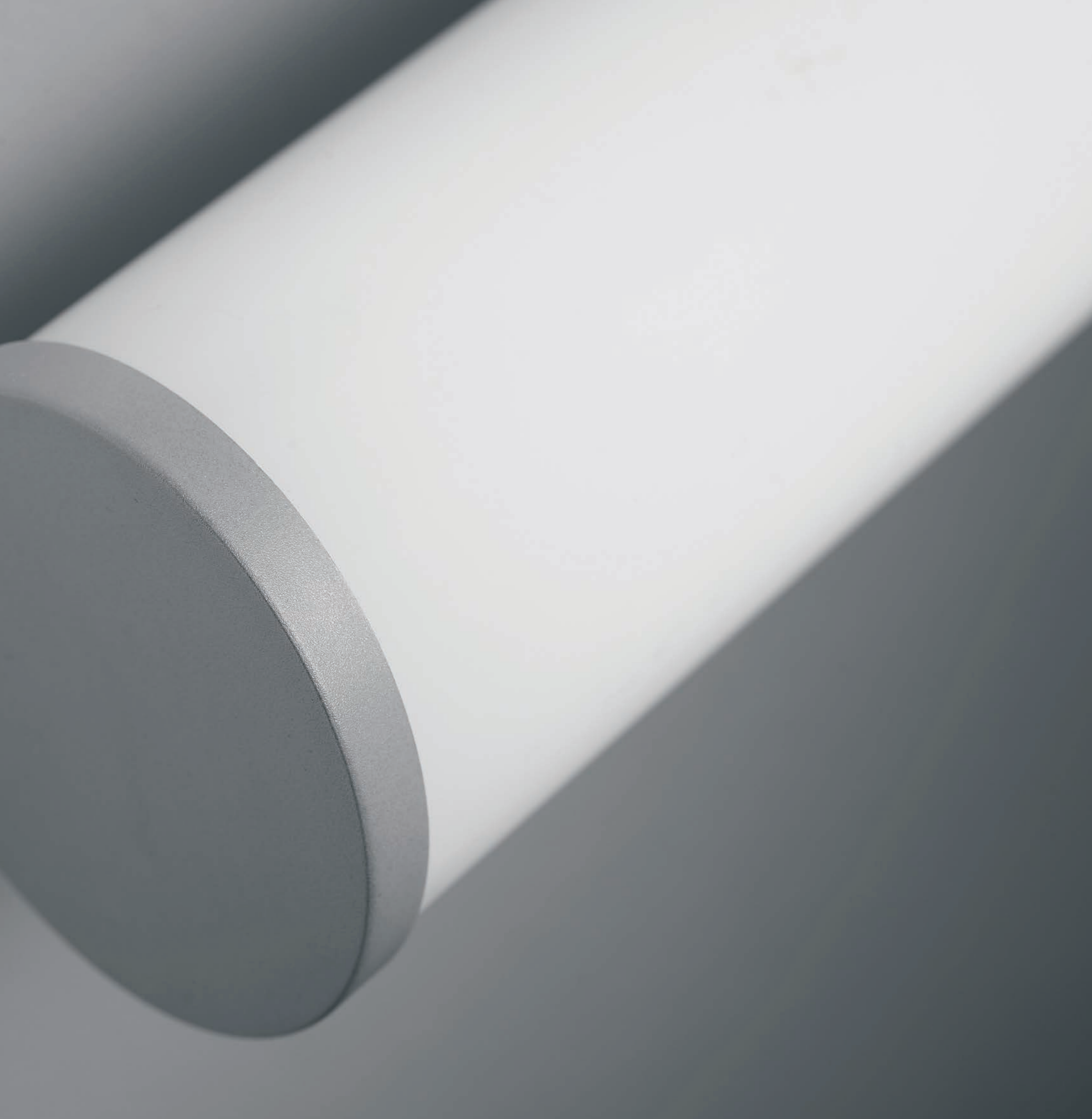

PROFILI LINEARI STRAIGHT PROFILES

Elementi di illuminazione lineari con struttura in alluminio estruso e copertura opale una perfetta diffusione della luce. Nella collezione sono presenti prodotti installabili a soffitto, a parete, a sospensione o piantane da terra.

Linear lighting fixtures with extruded aluminium structure and opal cover for a perfect light diffusion. The collection includes products that can be installed on the ceiling, on the wall, as a suspension as well as floor lamps.

Lineare Beleuchtungssysteme mit einer Struktur aus extrudiertem Aluminium und Opalabdeckung sorgen für eine perfekte Lichtstreuung. Die Kollektion umfasst Decken-, Wand-, Hänge- und Stehleuchten.

Elementos lineales de iluminación con estructura de aluminio extruido y cobertura ópalo para tener una difusión perfecta de la luz. La colección incluye productos que pueden instalarse en techo, pared, suspensión o suelo.

Прямые осветительные приборы с корпусом из экструдированного алюминия и опаловым покрытием для идеального рассеивания света. В коллекции имеются приборы, которые можно установить на потолке или на стене, а также подвесные светильники или напольные торшеры.



PIRGOS



- Profilo in alluminio con copertura opale
- Led 21,6 W/mt
- Tappi in plastica grigia
- Alimentatore integrato

- Aluminium profile with opal covering
- 21.6 W/m LED
- Grey plastic caps
- Integrated power supply unit

- Aluminiumprofil mit opalweißer Abdeckung
- LED 21,6 W/m
- Stopfen aus grauem Kunststoff
- Integriertes Netzteil

- Perfil de aluminio con cobertura ópalo
- Led 21,6 W/m
- Tapones de plástico gris
- Fuente de alimentación incorporada

- Алюминиевый профиль с опаловым покрытием
- Светодиод 21,6 Вт/м
- Заглушки из серого пластика
- Интегрированный блок питания

Omologazioni

CE IP40

Type-approvals

CE IP40

Zulassungen

CE IP40

Homologaciones

CE IP40

Омологации

CE IP40

T311.10

- 1 mt
- 19,2W
- 24V
- 3000°K
- 2000 Lumen

T311.10.D

* - Dimmerabile - Dimmable
- Dimmerfähig - Intensidad regulable
- С регулируемой яркостью

- 1 mt
- 19,2W
- 24V
- 3000°K
- 2000 Lumen

T311.11

- 2 mt
- 38,4W
- 24V
- 3000°K
- 4000 Lumen

T311.11.D

* - Dimmerabile - Dimmable
- Dimmerfähig - Intensidad regulable
- С регулируемой яркостью

- 2 mt
- 38,4W
- 24V
- 3000°K
- 4000 Lumen

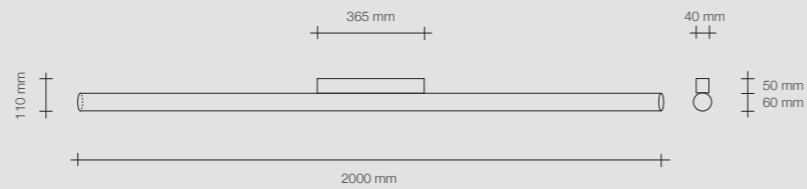
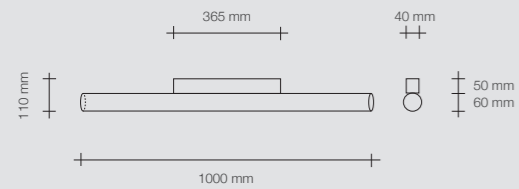

* - Dimmerabile con pulsante normalmente aperto
- Dimmable with normally open button
- Dimmerbar mit taste normalerweise offen
- Intensidad luminosa no regulable con pulsador normalmente abierto
- Диммируется с помощью технологии нормально разомкнутый контакт





PIRGOS



- Profilo in alluminio con copertura opale
- Led 21,6 W/mt
- Tappi in plastica grigia
- Alimentatore nel rosone a soffitto

- Aluminium profile with opal covering
- 21.6 W/m LED
- Grey plastic caps
- Charger in ceiling rose

- Aluminiumprofil mit opalweißer Abdeckung
- LED 21,6 W/m
- Stopfen aus grauem Kunststoff
- Netzteil in der Rosette an der Decke

- Perfil de aluminio con cobertura ópalo
- Led 21,6 W/m
- Tapones de plástico gris
- Fuente de alimentación en el rosetón de techo

- Алюминиевый профиль с опаловым покрытием
- Светодиод 21,6 Вт/м
- Заглушки из серого пластика
- Блок питания, встроенный в потолочную чашку

Omologazioni
CE IP40

Type-approvals
CE IP40

Zulassungen
CE IP40

Homologaciones
CE IP40

Омологации
CE IP40

T311.30

_1 mt
_19,2W
_24V
_3000°K
_2000 Lumen

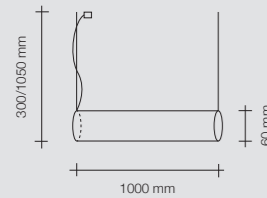

- Misura rosone
- Rose measurement
- Maße der Rosette
- Medida del rosetón
- Размер чашки

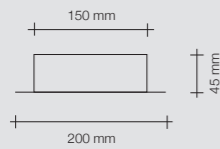

T311.30.D

* - Dimmerabile - Dimmable
- Dimmerfähig - Intensidad regulable
- С регулируемой яркостью

_1 mt
_19,2W
_24V
_3000°K
_2000 Lumen

T311.31

_2 mt
_38,4W
_24V
_3000°K
_4000 Lumen

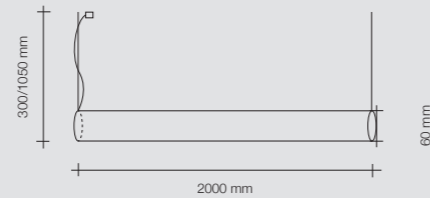

T311.31.D

* - Dimmerabile - Dimmable
- Dimmerfähig - Intensidad regulable
- С регулируемой яркостью

_2 mt
_38,4W
_24V
_3000°K
_4000 Lumen

* - Dimmerabile con PUSH 0-10V/1-10V Dali/Pulsante normalmente aperto
- Dimmable with PUSH 0-10V/1-10V Dali/Normally open button
- Dimmerbar mit PUSH 0-10V/1-10V Dali/Taste normalerweise offen
- Intensidad luminosa no regulable con PUSH 0-10V/1-10V Dali/Pulsador normalmente abierto
- Диммируется с помощью технологий PUSH 0-10V/1-10V Dali/Нормально разомкнутый контакт







- Profilo in alluminio con copertura opale
- Led 43,2 W
- Tappi in plastica grigia
- Alimentatore nella spina
- Lampada dimmerabile
- Con dimmer a piede

Omologazioni
 CE IP40

- Perfil de aluminio con cobertura ópalo
- Led 43,2 W
- Tapones de plástico gris
- Fuente de alimentación en la clavija
- Lámpara de intensidad regulable
- Con regulador de intensidad de pie

Homologaciones
 CE IP40

- Aluminium profile with milky white cover
- 43,2 W LED
- Grey plastic caps
- Power supply in the plug
- Dimmable light
- With foot operated dimmer switch

Type-approvals
 CE IP40

- Алюминиевый профиль с опальным покрытием
- Светодиод 43,2 Вт
- Серые пластиковые заглушки
- Блок питания встроен в вилке
- Диммируемая лампочка
- с диммером с ножным управлением

Омолгации
 CE IP40

- Aluminiumprofil mit opalfarbener Abdeckung
- LED mit 43,2 W
- Kappen aus grauem Kunststoff
- Netzteil im Stecker
- Dimmerbare Lampe
- Mit Fußdimmer

Zulassungen
 CE IP40

T311.50



- 2 mt
- 38,4 W
- 24 V
- 3000°K
- 4000 lumen
- Dimmer a piede
- Foot operated dimmer switch
- Fußdimmer
- Regulador de intensidad de pie
- диммер с ножным управлением

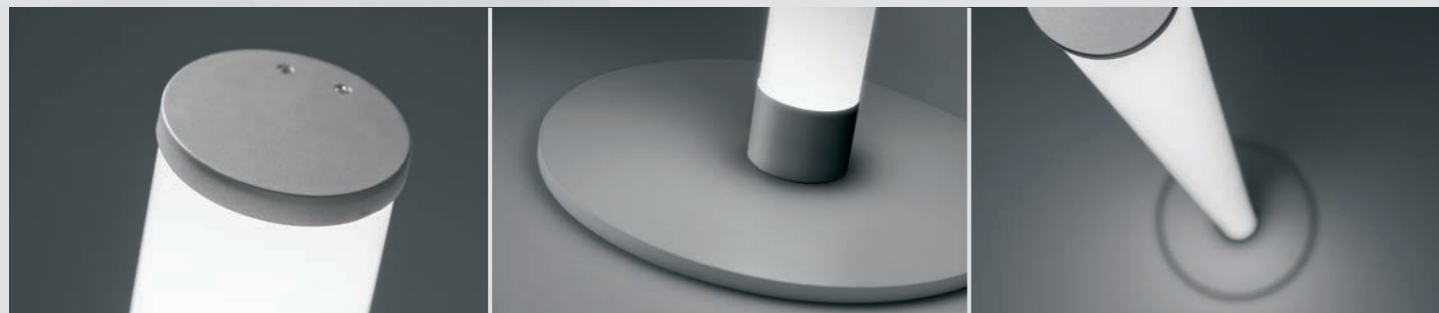





INCASSI IN GESSO A SOFFITTO RECESSED PLASTER CEILING LIGHTS

Serie di apparecchi da incasso in gesso a scomparsa totale per controsoffitti o pareti in cartongesso e con controcassa per laterizi. Nati per soddisfare le esigenze di applicazioni moderne, suggestive e discrete.

Range of plaster products for fully recessed installation in false ceilings or walls in plasterboard and with recessed fixing kit for brick-built structures. Created to meet the needs of modern, elegant and discreet applications.

Geräteserie zum Einlassen aus Gips, vollständig verschwindend, für abgehängte Decken oder Gipskartonwände und mit Außengehäuse für Mauerwerk. Wurden für moderne, suggestive und diskrete Anwendungsmöglichkeiten entworfen.

Serie de aparatos para empotrar en yeso completamente escamoteables para falsos techos o paredes de cartón yeso y con contracaja para ladrillos. Creados para satisfacer las exigencias de aplicaciones modernas, sugestivas y discretas.

Серия встраиваемых и полностью скрываемых приборов из гипса для подвесных потолков или перегородок из гипсокартона, а также с специальным корпусом для установки в кирпичные стены или потолки. Эта серия была разработана для удовлетворения требований, связанных с ее современными, привлекательными и ненавязчивыми применениями.







- Lampada a incasso per cartongesso ad una luce
- Per lampadine GX53
- Lampadine installabili: fluorescenti, led
- Dopo aver rasato a gesso il cartongesso l'incasso risulta parte integrante del muro stesso e può essere tinteggiato
- Foro di installazione suggerito ø 125 mm

- Built-in one-light lamp for plasterboard
- For GX53 bulbs
- Bulbs: fluorescent or LED
- After chalk finishing the plasterboard, the lamp built-in becomes an integral part of the wall and can be painted
- Recommended installation hole: ø 125 mm

- Einbauleuchte für Gipskarton mit einem Leuchtmittel
- für GX53 Leuchtmittel
- installierbare Leuchtmittel: Leuchtstoff, LED
- Nachdem der Gipskarton glatt verputzt wurde, wird die Einbauleuchte zu einem integrierenden Bestandteil der Mauer und kann gestrichen werden
- Empfohlene Einbauöffnung: ø 125 mm

- Luminaria de empotrar, para cartón yeso con una luz
- Para lámparas GX53
- Lámparas que se pueden instalar: fluorescentes, LED
- Después de haber enrasado con yeso el cartón yeso el empotrado forma parte integrante de la pared y se puede pintar
- Orificio para instalación aconsejado: ø 125 mm

- Встраиваемый светильник для гипсокартона с одной лампочкой
- Лампы с цоколем GX53
- Применяемые лампочки: флуоресцентные, светодиодные
- После выравнивания гипсокартона встраиваемый светильник становится неотъемлемой частью стены и можно его покрасить
- Рекомендуемое монтажное отверстие: ø 125 mm

Omologazioni

CE V D

Type-approvals

CE V D

Zulassungen

CE V D

Homologaciones

CE V D

Омологации

CE V D



T337



- GX53
- 1x10W

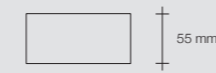
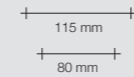

Ø 125 mm
Foro per installazione suggerito
Recommended installation hole
Empfohlene Einbauöffnung
Orificio para instalación aconsejado
Рекомендуемое монтажное отверстие

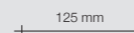





- Lampada a incasso per cartongesso ad una luce con bordo in metallo verniciato nero
- Per lampadine GX53
- Lampadine installabili: fluorescenti, led
- Dopo aver rasato a gesso il cartongesso l'incasso risulta parte integrante del muro stesso e può essere tinteggiato
- Foro di installazione ø 125 mm

- Built-in one-light lamp for plasterboard with black varnished metal edge
- For GX53 bulbs
- Bulbs: fluorescent or LED
- After chalk finishing the plaster board, the lamp built-in becomes an integral part of the wall and can be painted
- Recommended installation hole: ø 125 mm

- Einbauleuchte für Gipskarton mit einem Leuchtmittel und schwarz lackiertem Metallrahmen
- für GX53 Leuchtmittel
- installierbare Leuchtmittel: Leuchtstoff, LED
- Nachdem der Gipskarton glatt verputzt wurde, wird die Einbauleuchte zu einem integrierenden Bestandteil der Mauer und kann gestrichen werden
- Empfohlene Einbauöffnung: ø 125 mm

- Luminaria de empotrar, para cartón yeso, con una luz, con borde de metal pintado de negro
- Para lámparas GX53
- Lámparas que se pueden instalar: fluorescentes, LED
- Después de haber enrasado con yeso el cartón yeso el empotrado forma parte integrante de la pared y se puede pintar
- Orificio para instalación aconsejado: ø 125 mm

- Встраиваемый светильник для гипсокартона с одной лампочкой и металлической рамой, окрашенной в чёрный цвет
- Лампы с цоколем GX53
- Применяемые лампочки: флуоресцентные, светодиодные
- После выравнивания гипсокартона гипсом встраиваемый светильник становится неотъемлемой частью стены и можно его покрасить
- Рекомендуемое монтажное отверстие: ø 125 mm

Omologazioni



Type-approvals



Zulassungen



Homologaciones



Омологации



T338



- GX53
- 1x10W

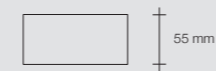
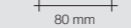
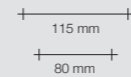

Ø 125 mm
Foro per installazione suggerito
Recommended installation hole
Empfohlene Einbauöffnung
Orificio para instalación aconsejado
Рекомендуемое монтажное отверстие

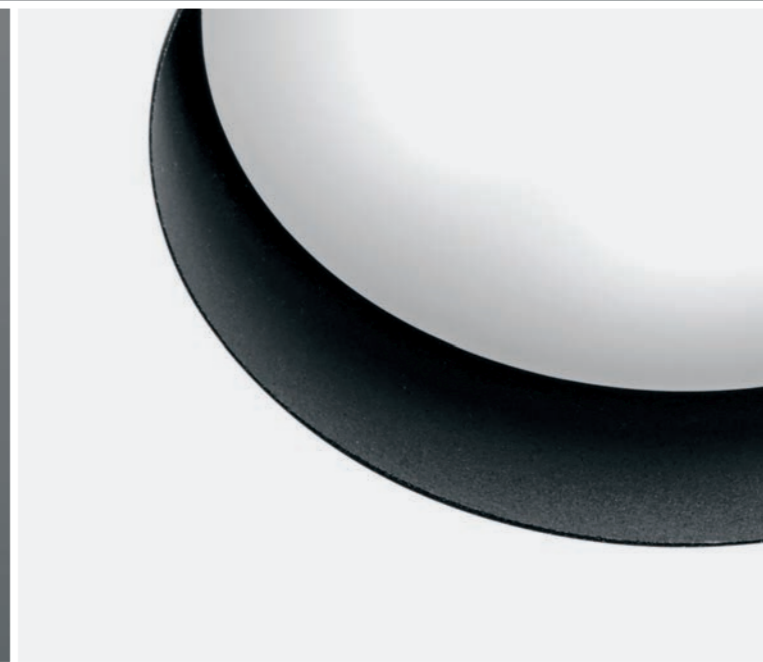
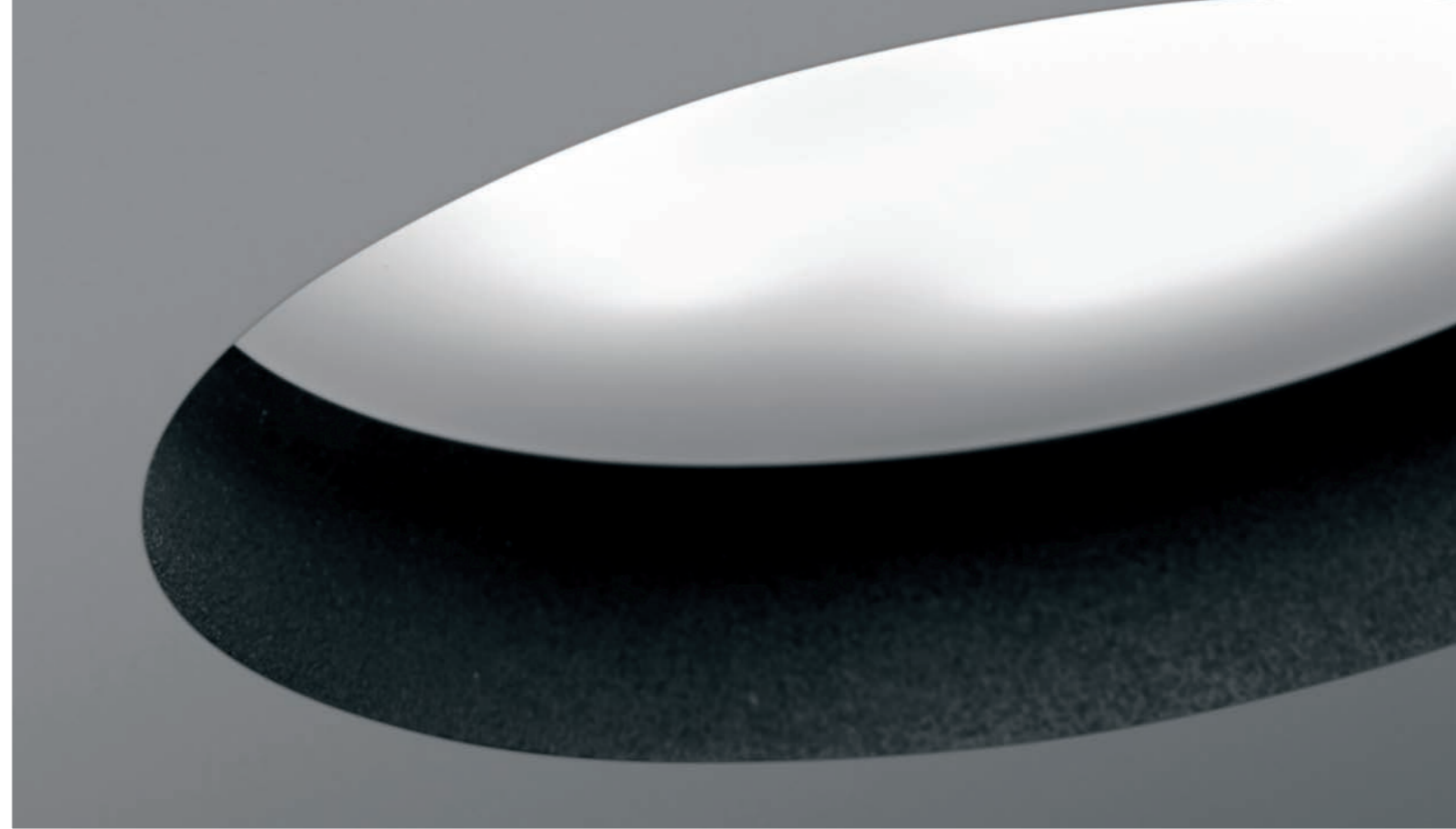
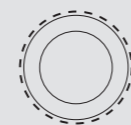
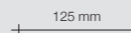



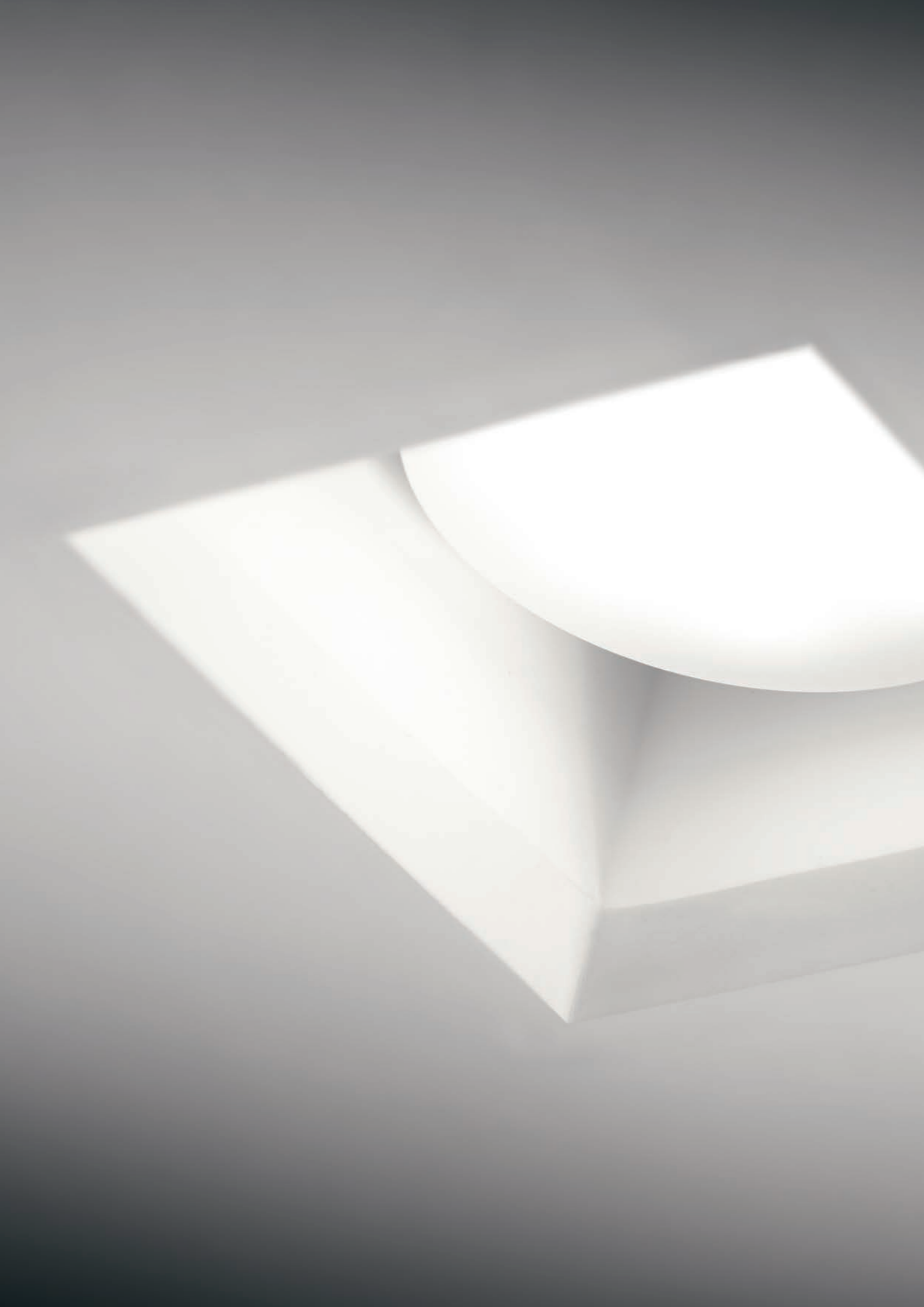



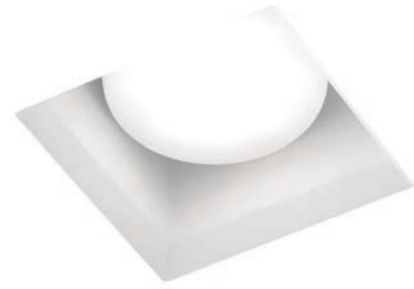

- Lampada a incasso per cartongesso ad una luce
- Per lampadine GX53
- Lampadine installabili: fluorescenti, led
- Dopo aver rasato a gesso il cartongesso l'incasso risulta parte integrante del muro stesso e può essere tinteggiato
- Foro di installazione suggerito 123 mm x 123 mm

- Built-in one-light lamp for plasterboard
- For GX53 bulbs
- Bulbs: fluorescent or LED
- After chalk finishing the plasterboard, the lamp built-in becomes an integral part of the wall and can be painted
- Recommended installation hole: 123 mm x 123 mm

- Einbauleuchte für Gipskarton mit einem Leuchtmittel
- für GX53 Leuchtmittel
- installierbare Leuchtmittel: Leuchtstoff, LED
- Nachdem der Gipskarton glatt verputzt wurde, wird die Einbauleuchte zu einem integrierenden Bestandteil der Mauer und kann gestrichen werden
- Empfohlene Einbauöffnung: 123 mm x 123 mm

- Luminaria de empotrar, para cartón yeso con una luz
- Para lámparas GX53
- Lámparas que se pueden instalar: fluorescentes, LED
- Después de haber enrasado con yeso el cartón yeso el empotrado forma parte integrante de la pared y se puede pintar
- Orificio para instalación aconsejado: 123 mm x 123 mm

- Встраиваемый светильник для гипсокартона с одной лампочкой
- Лампы с цоколем GX53
- Применяемые лампочки: флуоресцентные, светодиодные
- После выравнивания гипсокартона гипсом встраиваемый светильник становится неотъемлемой частью стены и можно его покрасить
- Рекомендуемое монтажное отверстие: 123 mm x 123 mm

Omologazioni



Type-approvals



Zulassungen



Homologaciones



Омологации



T381



- GX53
- 1x10W

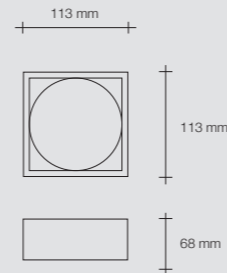

123 mm x 123 mm
Foro per installazione suggerito
Recommended installation hole
Empfohlene Einbauöffnung
Orificio para instalación aconsejado
Рекомендуемое монтажное отверстие

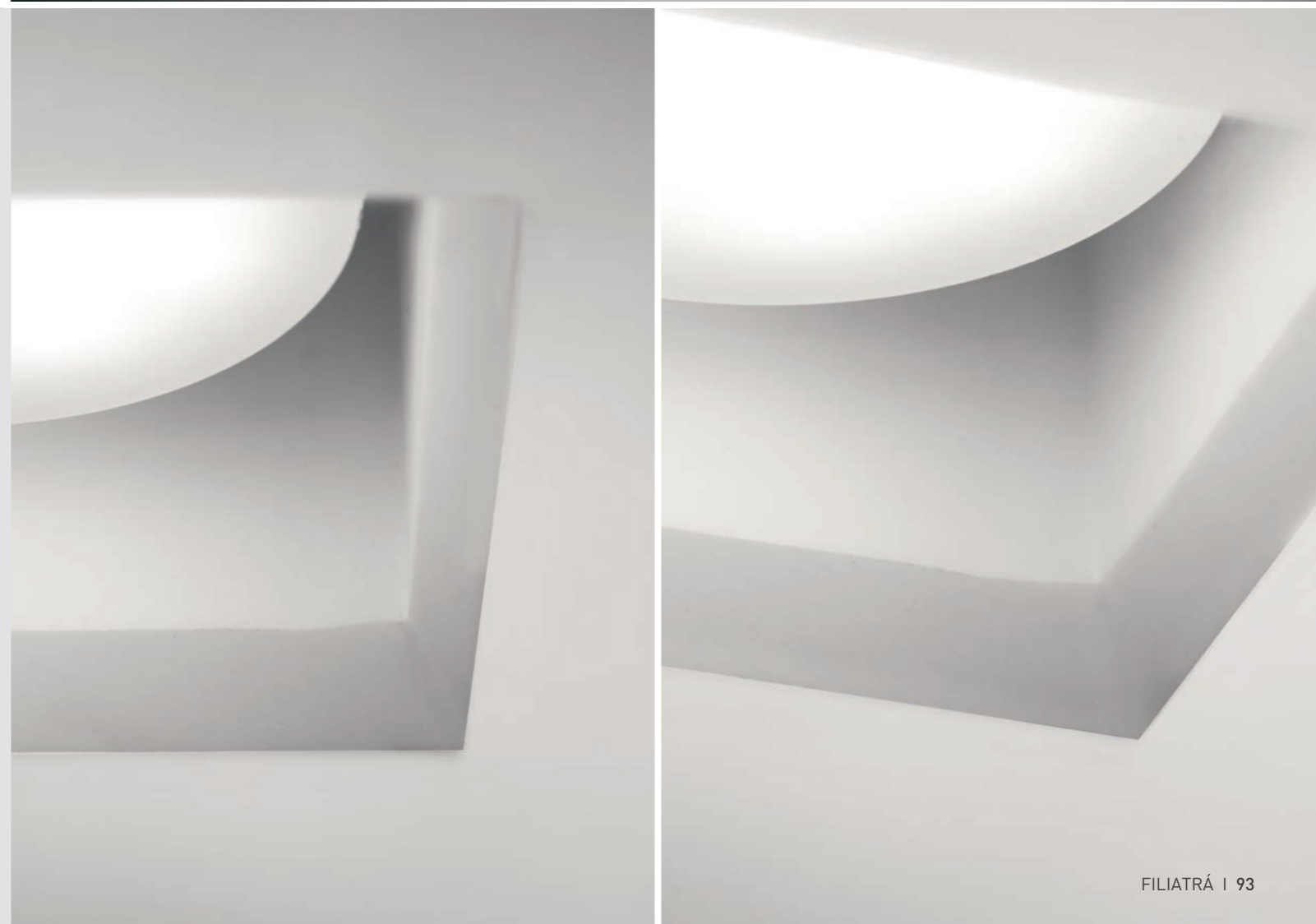
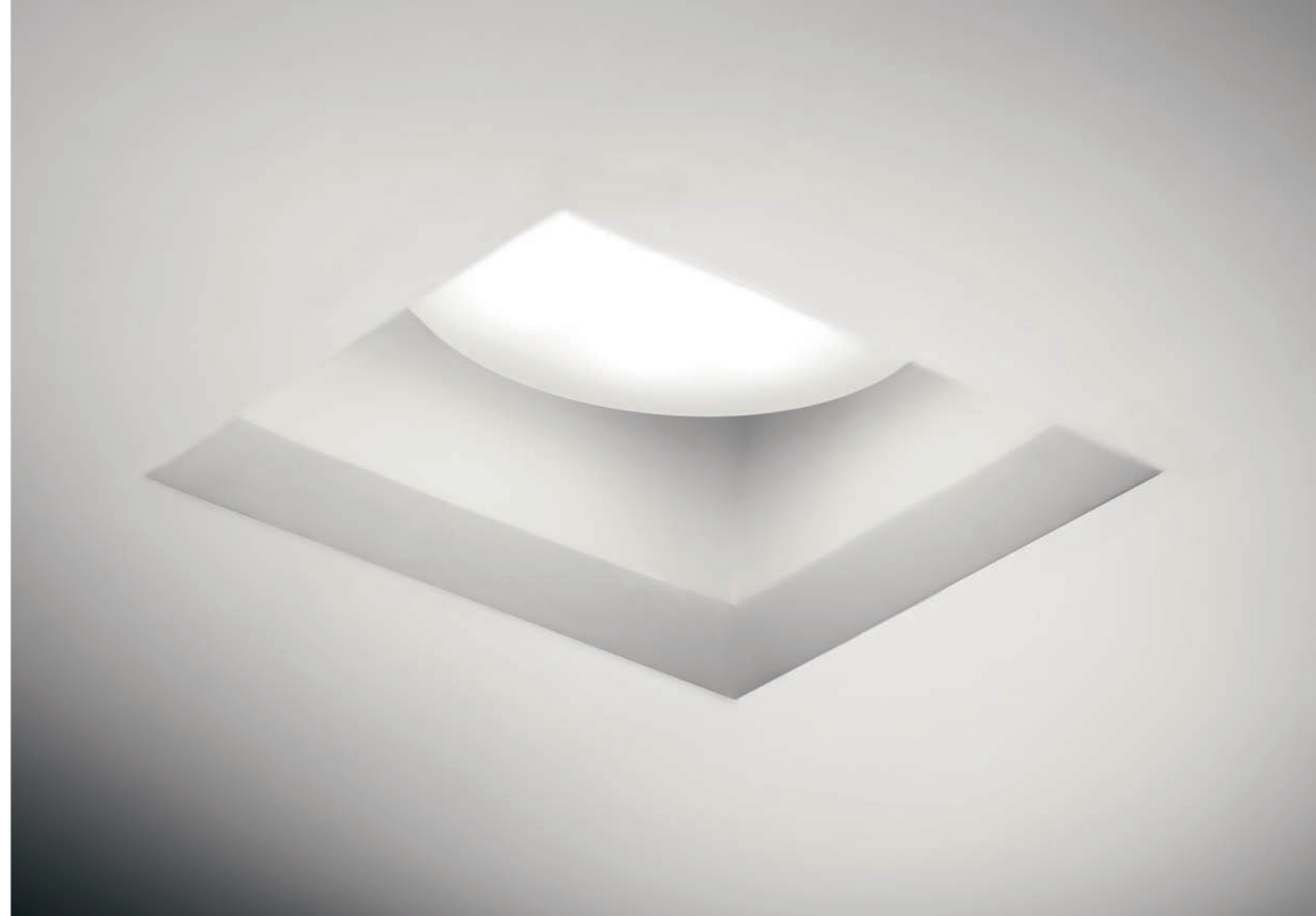
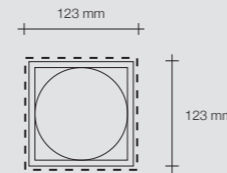



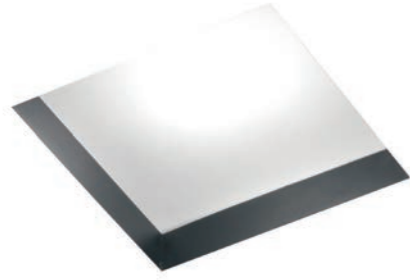

- Lampada a incasso per cartongesso ad una luce con diffusore in vetro
- Per lampadine GX53
- Lampadine installabili: fluorescenti, led
- Dopo aver rasato a gesso il cartongesso l'incasso risulta parte integrante del muro stesso e può essere tinteggiato
- Foro di installazione suggerito 123 mm x 123 mm

- Built-in one-light lamp for plasterboard with glass diffuser
- For GX53 bulbs
- Bulbs: fluorescent or LED
- After chalk finishing the plasterboard, the lamp built-in becomes an integral part of the wall and can be painted
- Recommended installation hole: 123 mm x 123 mm

- Einbauleuchte für Gipskarton mit einem Leuchtmittel und Diffusorabdeckung aus Glas
- für GX53 Leuchtmittel
- installierbare Leuchtmittel: Leuchtstoff, LED
- Nachdem der Gipskarton glatt verputzt wurde, wird die Einbauleuchte zu einem integrierenden Bestandteil der Mauer und kann gestrichen werden
- Empfohlene Einbauöffnung: 123 mm x 123 mm

- Luminaria de empotrar, para cartón yeso con una luz con difusor de vidrio
- Para lámparas GX53
- Lámparas que se pueden instalar: fluorescentes, LED
- Después de haber enrasado con yeso el cartón yeso el empotrado forma parte integrante de la pared y se puede pintar
- Orificio para instalación aconsejado: 123 mm x 123 mm

- Встраиваемый светильник для гипсокартона с одной лампочкой и стеклянным рассеивателем
- Лампы с цоколем GX53
- Применяемые лампочки: флуоресцентные, светодиодные
- После выравнивания гипсокартона гипсом встраиваемый светильник становится неотъемлемой частью стены и можно его покрасить
- Рекомендуемое монтажное отверстие: 123 mm x 123 mm

Omologazioni



Type-approvals



Zulassungen



Homologaciones



Омологации



T382



- GX53
- 1x10W

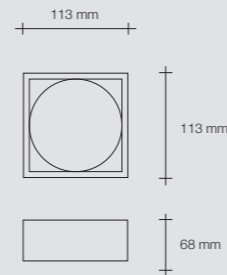

123 mm x 123 mm
 Foro per installazione suggerito
 Recommended installation hole
 Empfohlene Einbauöffnung
 Orificio para instalación aconsejado
 Рекомендуемое монтажное отверстие

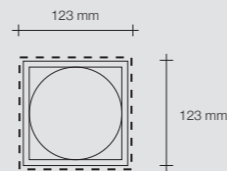





- Lampada a incasso per cartongesso ad una luce con diffusore in vetro
- Per lampadine GX53
- Lampadine installabili: fluorescenti, led
- Dopo aver rasato a gesso il cartongesso l'incasso risulta parte integrante del muro stesso e può essere tinteggiato
- Foro di installazione suggerito 123 mm x 123 mm

- Built-in one-light lamp for plasterboard with glass diffuser
- For GX53 bulbs
- Bulbs: fluorescent or LED
- After chalk finishing the plasterboard, the lamp built-in becomes an integral part of the wall and can be painted
- Recommended installation hole: 123 mm x 123 mm

- Einbauleuchte für Gipskarton mit einem Leuchtmittel und Diffusorabdeckung aus Glas
- für GX53 Leuchtmittel
- installierbare Leuchtmittel: Leuchtstoff, LED
- Nachdem der Gipskarton glatt verputzt wurde, wird die Einbauleuchte zu einem integrierenden Bestandteil der Mauer und kann gestrichen werden
- Empfohlene Einbauöffnung: 123 mm x 123 mm

- Luminaria de empotrar, para cartón yeso con una luz con difusor de vidrio
- Para lámparas GX53
- Lámparas que se pueden instalar: fluorescentes, LED
- Después de haber enrasado con yeso el cartón yeso el empotrado forma parte integrante de la pared y se puede pintar
- Orificio para instalación aconsejado: 123 mm x 123 mm

- Встраиваемый светильник для гипсокартона с одной лампочкой и стеклянным рассеивателем
- Лампы с цоколем GX53
- Применяемые лампочки: флуоресцентные, светодиодные
- После выравнивания гипсокартона гипсом встраиваемый светильник становится неотъемлемой частью стены и можно его покрасить
- Рекомендуемое монтажное отверстие: 123 mm x 123 mm

Omologazioni



Type-approvals



Zulassungen



Homologaciones



Омологации



T383



- GX53
- 1x10W

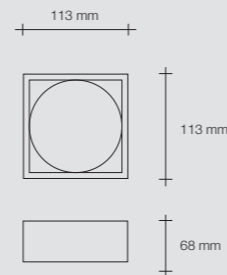

123 mm x 123 mm
 Foro per installazione suggerito
 Recommended installation hole
 Empfohlene Einbauöffnung
 Orificio para instalación aconsejado
 Рекомендуемое монтажное отверстие

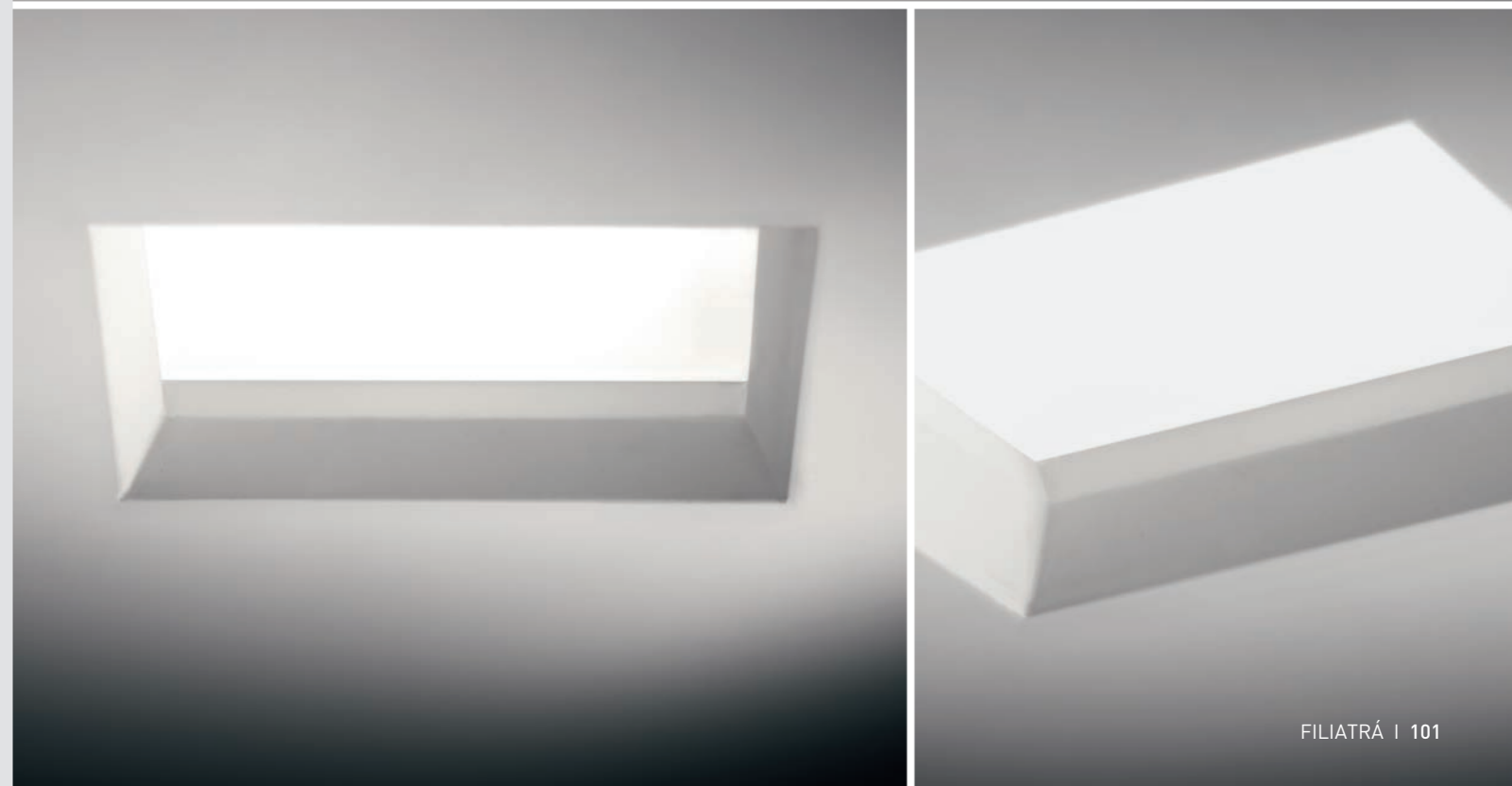
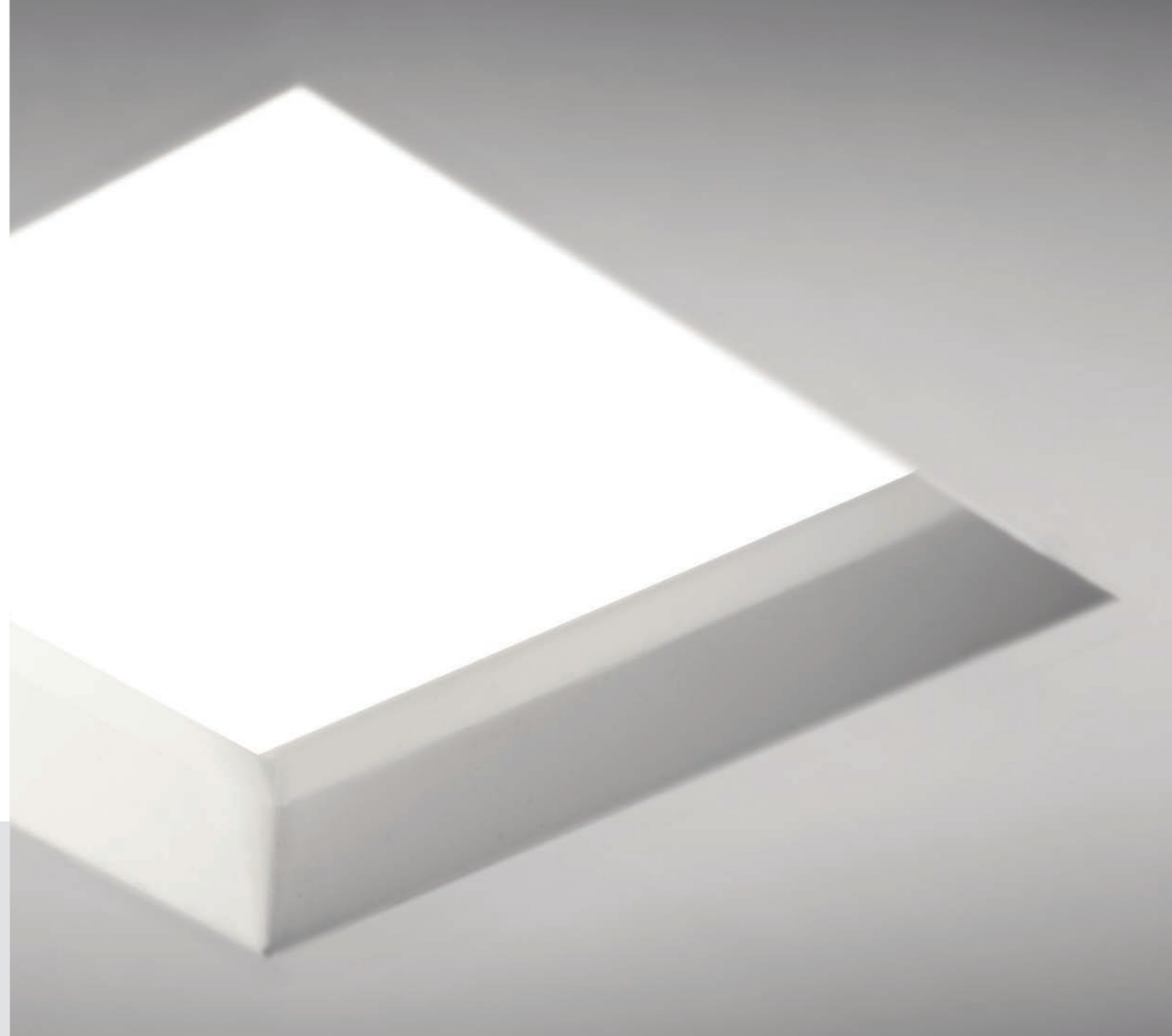
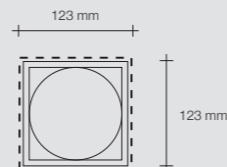





- Lampada a incasso per cartongesso con ghiera verniciata nera e griglia esagonale per il controllo del fascio luminoso
- Il prodotto viene fornito con due differenti griglie esagonali per adattare l'emissione al luogo di installazione
- Per lampadine GU10
- Lampadine installabili: fluorescenti, led
- Dopo aver rasato a gesso il cartongesso l'incasso risulta parte integrante del muro e può essere integgiato
- Foro di installazione 110 mm

- Recessed lamp (for plaster) with black painted ring-nut and hexagon grid for light beam control
- The product is supplied with two different hexagon grids, to adapt the emission to the installation site
- For GU10 bulbs
- Bulbs: fluorescent or LED
- After chalk finishing the plaster board, the lamp built-in becomes an integral part of the wall and can be painted
- Recommended installation hole: 110 mm

- Einbaulampe für Gipskarton mit schwarz lackierter Fassung und sechseckigem Raster zur Lichtlenkung
- Das Produkt wird mit zwei verschiedenen sechseckigen Gittern geliefert, um die Emission an den Aufstellungsort anzupassen
- Für GU10 Leuchtmittel
- Installierbare Leuchtmittel: Leuchtstoff, LED
- Nachdem der Gipskarton glatt verputzt wurde, wird die Einbauleuchte zu einem integrierenden Bestandteil der Mauer und kann gestrichen werden
- Empfohlene Einbauöffnung: 110 mm

- Lámpara empotrada para panel de yeso con corona pintada de color negro y rejilla hexagonal para controlar el haz de luz
- El producto se suministra con dos rejillas hexagonales diferentes para adaptar la emisión al lugar de instalación
- Para lámparas GU10
- Lámparas que se pueden instalar: fluorescentes, LED
- Después de haber enrasado con yeso el cartón yeso el empotrado forma parte integrante de la pared y se puede pintar
- Orificio para instalación aconsejado: \varnothing 110 mm

- Встраиваемый точечный светильник для гипсокартона с окрашенным в черный цвет кольцом и шестиугольной решеткой для регулировки светового пучка
- Изделие поставляется с двумя разными шестиугольными решетками для оптимальной адаптации испускаемого света к месту установки
- Лампы с цоколем GU10
- Применяемые лампочки: флуоресцентные, светодиодные
- После выравнивания гипсокартона встраиваемый светильник становится неотъемлемой частью стены и можно его покрасить
- Рекомендуемое монтажное отверстие: \varnothing 110 mm

Omologazioni



Type-approvals



Zulassungen



Homologaciones



Омологации



T384



- GU10
- 1x40W

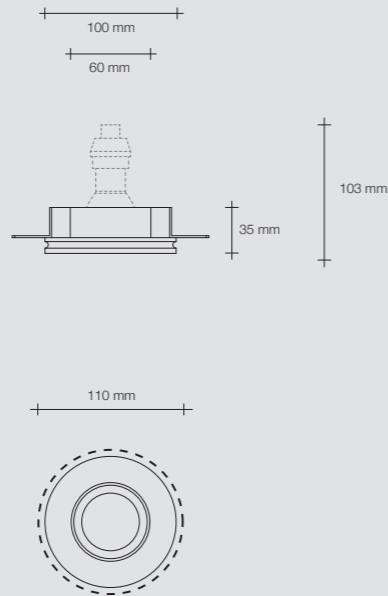

Ingombro complessivo di lampada con altezza indicativa di 50 mm e portalampada fornito
 Overall lamp (approx. 50 mm high) and lamp holder (supplied) size
 Gesamtabmessungen einschließlich Lampe mit einer ungefähren Höhe von 50 mm und mitgelieferter Lampenfassung
 Medidas con lámpara con altura indicativa de 50 mm y portalámparas incluido
 Габариты включают лампу высотой примерно 50 мм и входящий в комплект поставки цоколь

Ø 110 mm
 Foro per installazione suggerito
 Recommended installation hole
 Empfohlene Einbauöffnung
 Orificio para instalación aconsejado
 Рекомендуемое монтажное отверстие





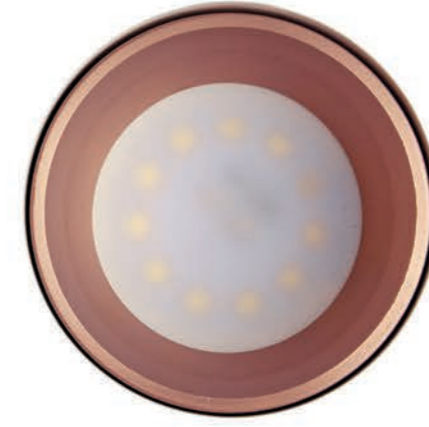
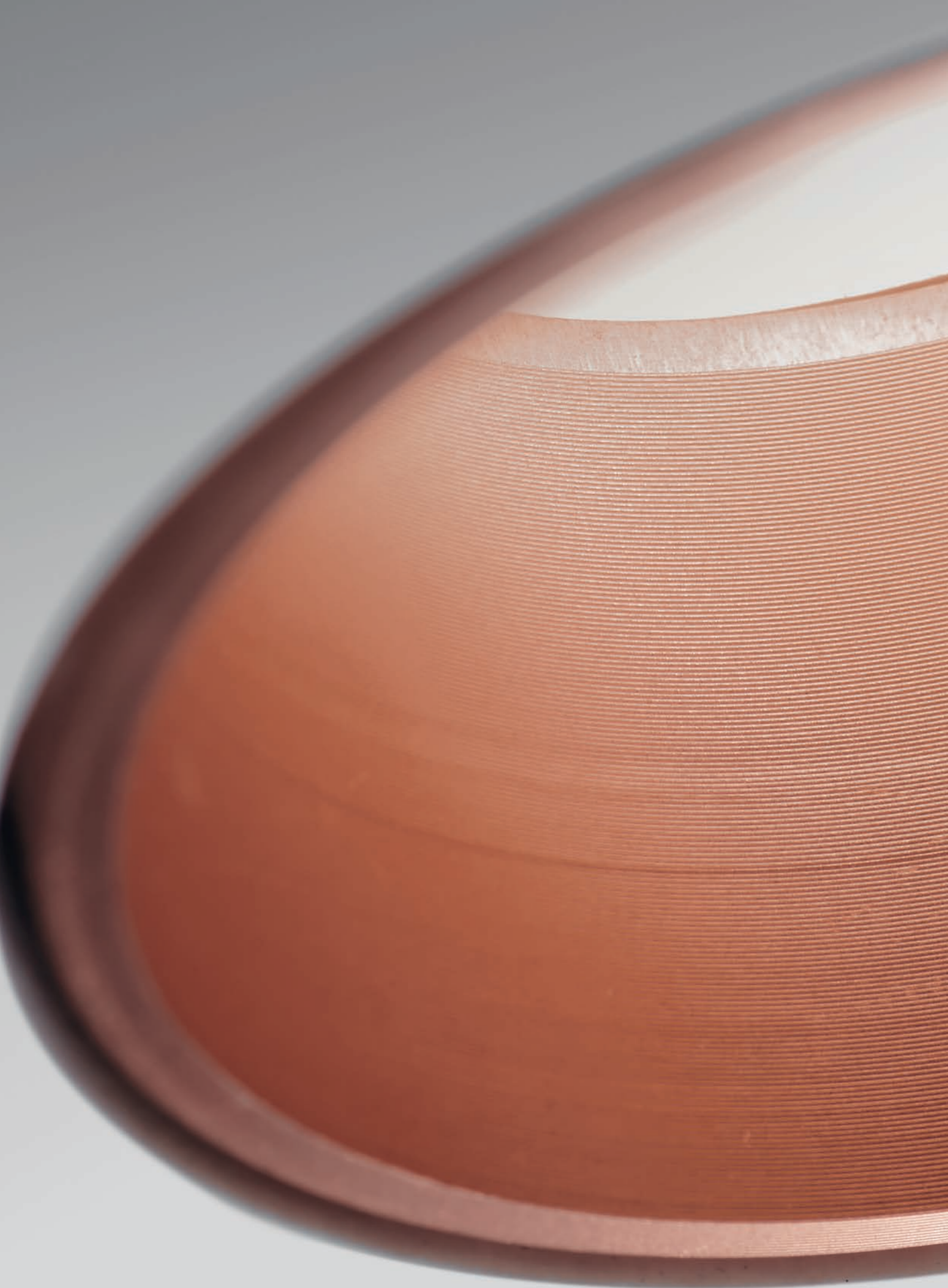



- Lampada a incasso per cartongesso a una luce con bordo metallico verniciato nero a filo muro
- Per lampadine GU10
- Lampadine installabili: fluorescenti, led
- Dopo aver rasato a gesso il cartongesso l'incasso risulta parte integrante del muro stesso e può essere tinteggiato
- Foro per installazione suggerito: ø 110 mm

- One-light recessed lamp (for plaster) with flush black painted metal edge
- For GU10 bulbs
- Bulbs: fluorescent, LED
- After chalk finishing the plasterboard, the lamp built-in becomes an integral part of the wall and can be painted
- Recommended installation hole: ø 110 mm

- Einbaulampe für Gipskarton für eine Lichtquelle mit schwarz lackiertem Metallrand bündig mit der Wand
- Für Leuchtmittel mit GU10 Fassung
- Installierbare Leuchtmittel: Leuchtstoff, LED
- Nachdem der Gipskarton glatt verputzt wurde, wird die Einbauleuchte zu einem integrierenden Bestandteil der Mauer und kann gestrichen werden
- Empfohlene Einbauöffnung: ø 110 mm

- Lámpara empotrada para panel de yeso con una luz con borde metálico pintado negro a ras de pared
- Para lámparas GU10
- Lámparas que se pueden instalar: fluorescentes, LED
- Después de haber enrasado con yeso el cartón yeso el empotrado forma parte integrante de la pared y se puede pintar
- Orificio para instalación aconsejado: ø 110 mm

- Встраиваемый точечный светильник для гипсокартона с одним источником света, с металлической окантовкой, окрашенной в черный цвет; устанавливается заподлицо со стеной
- Лампы с цоколем GU10
- Применяемые лампочки: флуоресцентные, светодиодные
- После выравнивания гипсокартона гипсовый встраиваемый светильник становится неотъемлемой частью стены и можно его покрасить
- Рекомендуемое монтажное отверстие: ø 110 mm

Omologazioni
CE V □

Type-approvals
CE V □

Zulassungen
CE V □

Homologaciones
CE V □

Омологации
CE V □

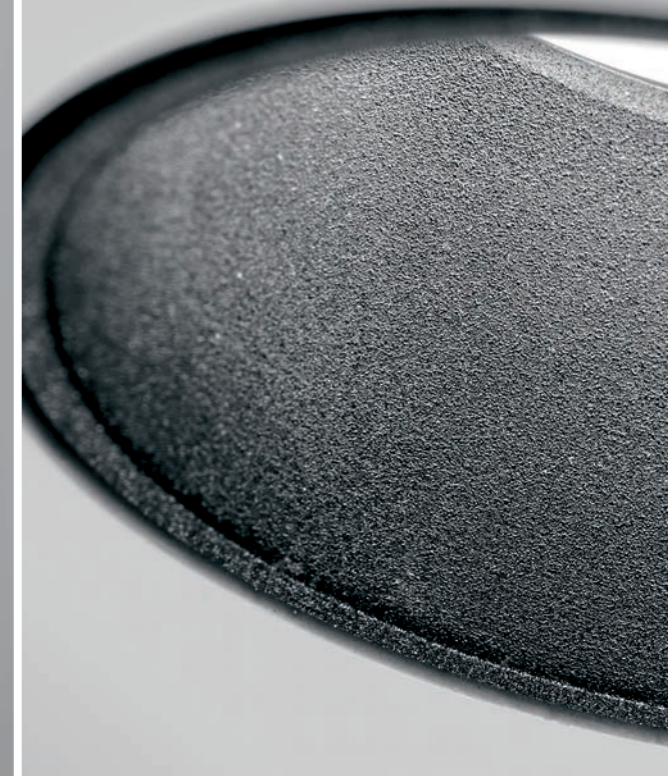

T390



- GU10
- 1x40W

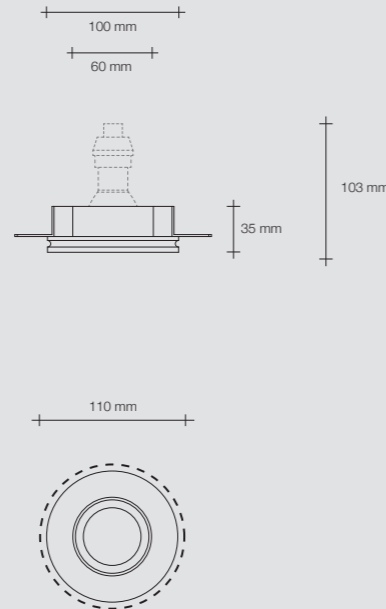

Ingombro comprensivo di lampada con altezza indicativa di 50 mm e portalampada fornito

Overall lamp (approx. 50 mm high) and lamp holder (supplied) size

Gesamtmaße einschließlich Lampe mit einer ungefähren Höhe von 50 mm und mitgelieferter Lampenfassung

Medidas con lámpara con altura indicativa de 50 mm y portalámparas incluido

Габариты включают лампу высотой примерно 50 мм и входящий в комплект поставки цоколь

Ø 110 mm

Foro per installazione suggerito
Recommended installation hole
Empfohlene Einbauöffnung
Orificio para instalación aconsejado
Рекомендуемое монтажное отверстие







- Lampada a incasso per cartongesso a una luce con bordo metallico verniciato bianco a filo muro
- Per lampadine GU10
- Lampadine installabili: fluorescenti, led
- Dopo aver rasato a gesso il cartongesso l'incasso risulta parte integrante del muro stesso e può essere tinteggiato
- Foro per installazione suggerito: ø 110 mm

- One-light recessed lamp (for plaster) with flush white painted metal edge
- For GU10 bulbs
- Bulbs: fluorescent, LED
- After chalk finishing the plasterboard, the lamp built-in becomes an integral part of the wall and can be painted
- Recommended installation hole: ø 110 mm

- Einbaulampe für Gipskarton für eine Lichtquelle mit weiß lackiertem Metallrand bündig mit der Wand
- Für Leuchtmittel mit GU10 Fassung
- Installierbare Leuchtmittel: Leuchtstoff, LED
- Nachdem der Gipskarton glatt verputzt wurde, wird die Einbauleuchte zu einem integrierenden Bestandteil der Mauer und kann gestrichen werden
- Empfohlene Einbauöffnung: ø 110 mm

- Lámpara empotrada para panel de eso con una luz con borde metálico pintado blanco a ras de pared
- Para lámparas GU10
- Lámparas que se pueden instalar: fluorescentes, LED
- Después de haber enrasado con yeso el cartón yeso el empotrado forma parte integrante de la pared y se puede pintar
- Orificio para instalación aconsejado: ø 110 mm

- Встраиваемый точечный светильник для гипсокартона с одним источником света, с металлической окантовкой, окрашенной в белый цвет; устанавливается заподлицо со стеной
- Лампы с цоколем GU10
- Применяемые лампочки: флуоресцентные, светодиодные
- После выравнивания гипсокартона гипсовый встраиваемый светильник становится неотъемлемой частью стены и можно его покрасить
- Рекомендуемое монтажное отверстие: ø 110 mm

Omologazioni

CE V □

Type-approvals

CE V □

Zulassungen

CE V □

Homologaciones

CE V □

Омологации

CE V □

T391



- GU10
- 1x40W

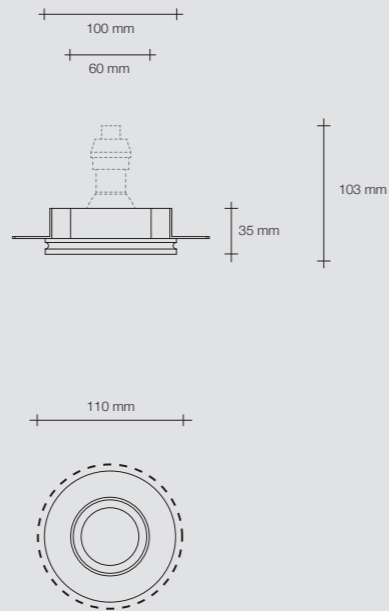

Ingombro comprensivo di lampada con altezza indicativa di 50 mm e portalampada fornito

Overall lamp (approx. 50 mm high) and lamp holder (supplied) size

Gesamtmaße einschließlich Lampe mit einer ungefähren Höhe von 50 mm und mitgelieferter Lampenfassung

Medidas con lámpara con altura indicativa de 50 mm y portalámparas incluido

Габариты включают лампу высотой примерно 50 мм и входящий в комплект поставки цоколь

Ø 110 mm

Foro per installazione suggerito
Recommended installation hole
Empfohlene Einbauöffnung
Orificio para instalación aconsejado
Рекомендуемое монтажное отверстие







- Lampada a incasso per cartongesso a una luce con bordo metallico oro spazzolato a filo muro
- Per lampadine GU10
- Lampadine installabili: fluorescenti, led
- Dopo aver rasato a gesso il cartongesso l'incasso risulta parte integrante del muro stesso e può essere tinteggiato
- Foro per installazione suggerito: ø 110 mm

- One-light recessed lamp (for plaster) with flush brushed gold metal edge
- For GU10 bulbs
- Bulbs: fluorescent, LED
- After chalk finishing the plasterboard, the lamp built-in becomes an integral part of the wall and can be painted
- Recommended installation hole: ø 110 mm

- Einbaulampe für Gipskarton für eine Lichtquelle mit goldfarbenem gebürstetem Metallrand bündig mit der Wand
- Für Leuchtmittel mit GU10 Fassung
- Installierbare Leuchtmittel: Leuchtstoff, LED
- Nachdem der Gipskarton glatt verputzt wurde, wird die Einbauleuchte zu einem integrierenden Bestandteil der Mauer und kann gestrichen werden
- Empfohlene Einbauöffnung: ø 110 mm

- Lámpara empotrada para panel de yeso con una luz con borde metálico dorado cepillado a ras de pared
- Para lámparas GU10
- Lámparas que se pueden instalar: fluorescentes, LED
- Después de haber enrasado con yeso el cartón yeso el empotrado forma parte integrante de la pared y se puede pintar
- Orificio para instalación aconsejado: ø 110 mm

- Встраиваемый точечный светильник для гипсокартона с одним источником света, с золотистой окантовкой из крацованного металла, устанавливается заподлицо со стеной
- Лампы с цоколем GU10
- Применяемые лампочки: флуоресцентные, светодиодные
- После выравнивания гипсокартона гипсом встраиваемый светильник становится неотъемлемой частью стены и можно его покрасить
- Рекомендуемое монтажное отверстие: ø 110 mm

Omologazioni
CE V □

Type-approvals
CE V □

Zulassungen
CE V □

Homologaciones
CE V □

Омологации
CE V □

T392



- GU10
- 1x40W

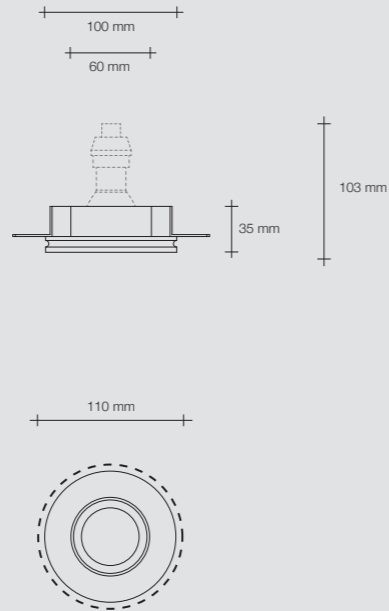

Ingombro complessivo di lampada con altezza indicativa di 50 mm e portalampana fornito

Overall lamp (approx. 50 mm high) and lamp holder (supplied) size

Gesamtabmessungen einschließlich Lampe mit einer ungefähren Höhe von 50 mm und mitgelieferter Lampenfassung

Medidas con lámpara con altura indicativa de 50 mm y portálamparas incluido

Габариты включают лампу высотой примерно 50 мм и входящий в комплект поставки цоколь

Ø 110 mm

Foro per installazione suggerito
Recommended installation hole
Empfohlene Einbauöffnung
Orificio para instalación aconsejado
Рекомендуемое монтажное отверстие

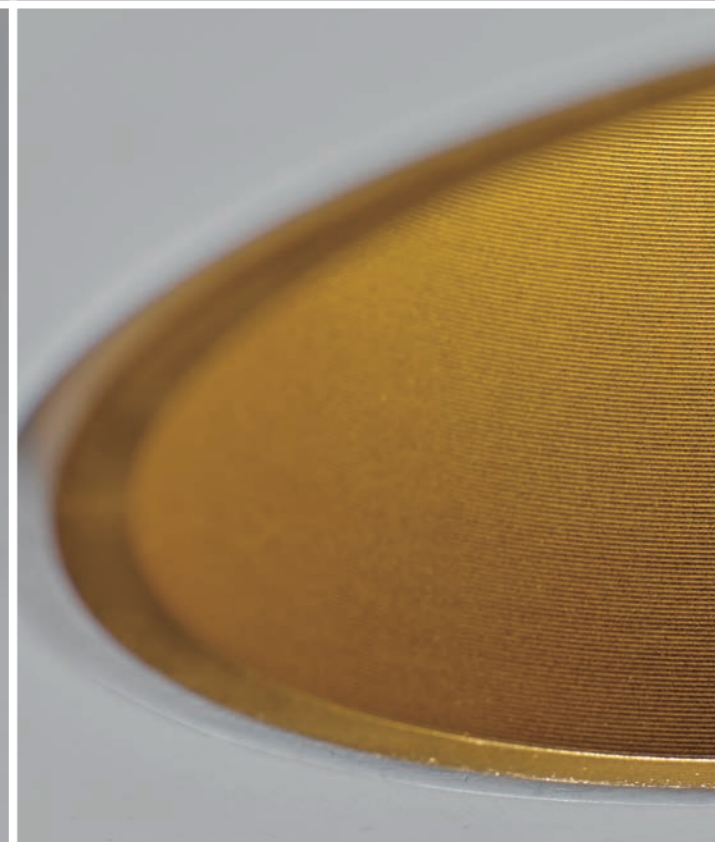
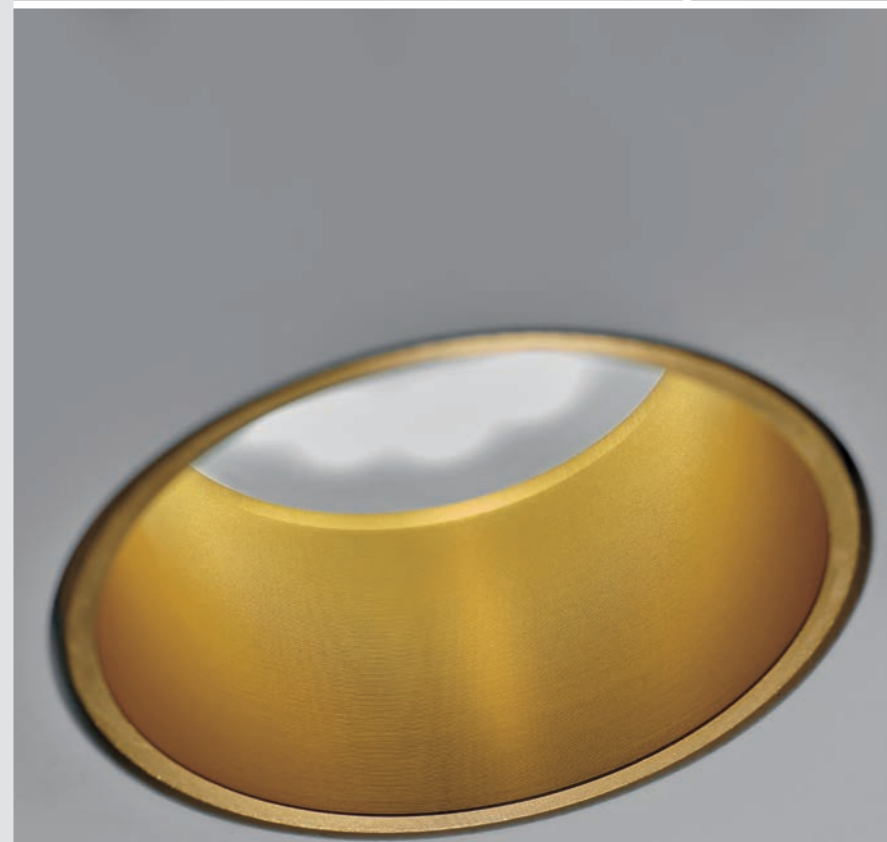
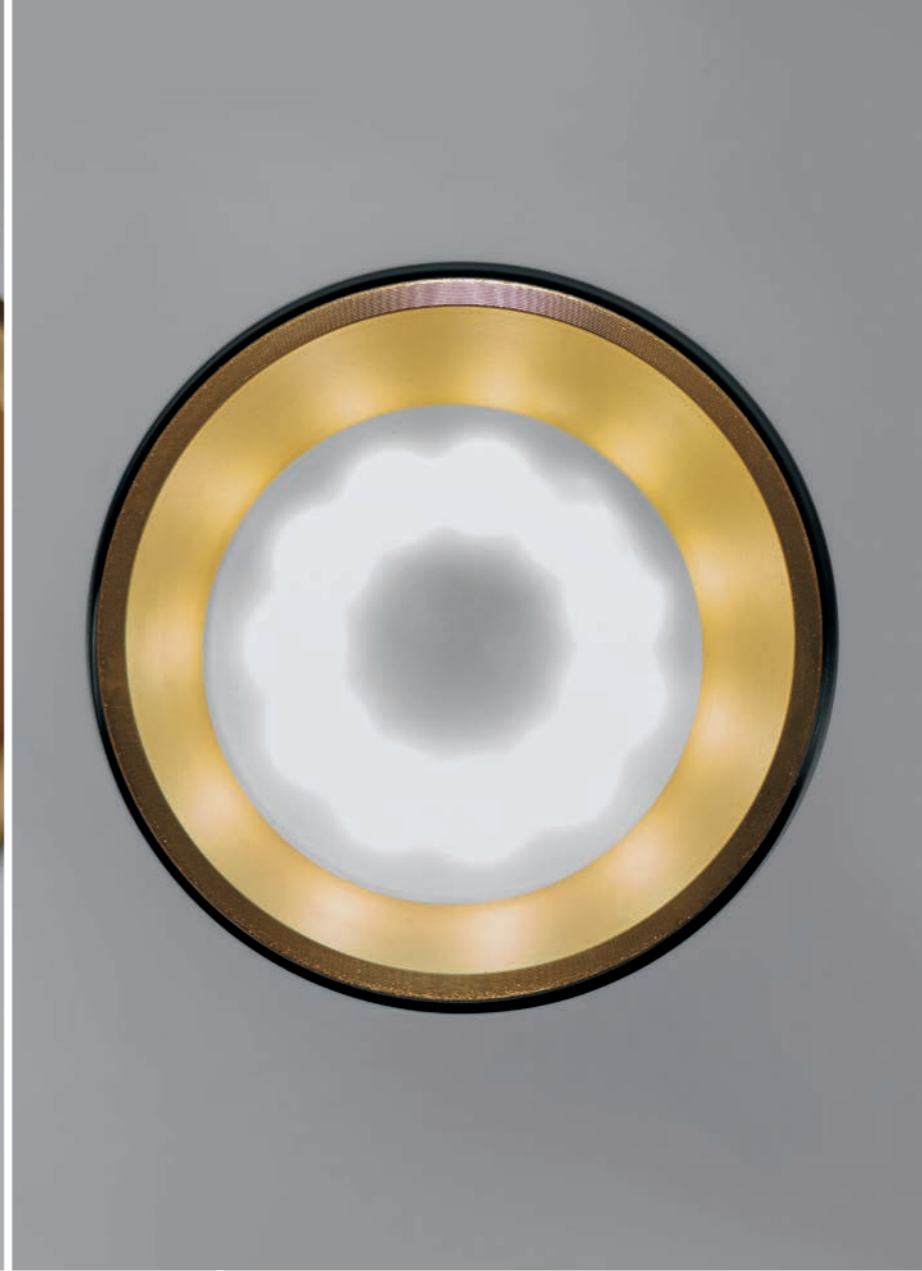





- Lampada a incasso per cartongesso a una luce con bordo metallico rame spazzolato a filo muro
- Per lampadine GU10
- Lampadine installabili: fluorescenti, led
- Dopo aver rasato a gesso il cartongesso l'incasso risulta parte integrante del muro stesso e può essere tinteggiato
- Foro per installazione suggerito: ø 110 mm

- One-light recessed lamp (for plaster) with flush brushed copper metal edge
- For GU10 bulbs
- Bulbs: fluorescent, LED
- After chalk finishing the plasterboard, the lamp built-in becomes an integral part of the wall and can be painted
- Recommended installation hole: ø 110 mm

- Einbaulampe für Gipskarton für eine Lichtquelle mit kupferfarbenem gebürstetem Metallrand bündig mit der Wand
- Für Leuchtmittel mit GU10 Fassung
- Installierbare Leuchtmittel: Leuchtstoff, LED
- Nachdem der Gipskarton glatt verputzt wurde, wird die Einbauleuchte zu einem integrierenden Bestandteil der Mauer und kann gestrichen werden
- Empfohlene Einbauöffnung: ø 110 mm

- Lámpara empotrada para panel de yeso con una luz con borde metálico de cobre cepillado a ras de pared
- Para lámparas GU10
- Lámparas que se pueden instalar: fluorescentes, LED
- Después de haber enrasado con yeso el cartón yeso el empotrado forma parte integrante de la pared y se puede pintar
- Orificio para instalación aconsejado: ø 110 mm

- Встраиваемый точечный светильник для гипсокартона с одним источником света, с окантовкой из крацованного металла медного цвета
- Лампы с цоколем GU10
- Применяемые лампочки: флуоресцентные, светодиодные
- После выравнивания гипсокартона гипсом встраиваемый светильник становится неотъемлемой частью стены и можно его покрасить
- Рекомендуемое монтажное отверстие: ø 110 mm

Omologazioni
CE V □

Type-approvals
CE V □

Zulassungen
CE V □

Homologaciones
CE V □

Омологации
CE V □

T393



- GU10
- 1x40W

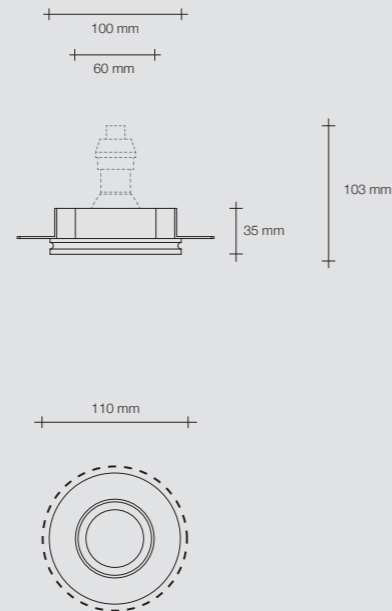

Ingombro comprensivo di lampada con altezza indicativa di 50 mm e portalampada fornito

Overall lamp (approx. 50 mm high) and lamp holder (supplied) size

Gesamtabmessungen einschließlich Lampe mit einer ungefähren Höhe von 50 mm und mitgelieferter Lampenfassung

Medidas con lámpara con altura indicativa de 50 mm y portalámparas incluido

Габариты включают лампу высотой примерно 50 мм и входящий в комплект поставки цоколь

Ø 110 mm

Foro per installazione suggerito
Recommended installation hole
Empfohlene Einbauöffnung
Orificio para instalación aconsejado
Рекомендуемое монтажное отверстие

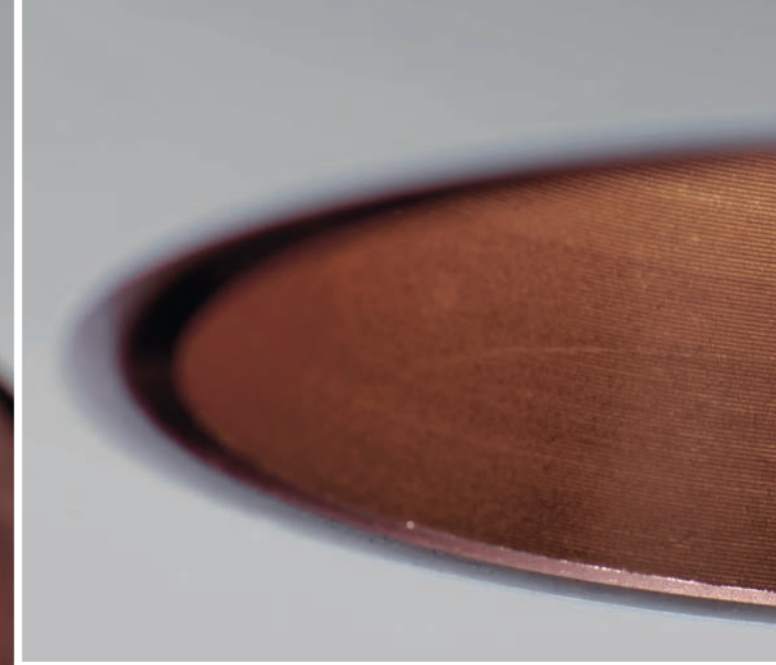





- Lampada a incasso per cartongesso ad una luce con cornice metallica verniciata nera
- Per lampadine GU10
- Lampadine installabili: alogene, fluorescenti, led
- Dopo aver rasato a gesso il cartongesso l'incasso risulta parte integrante del muro stesso e può essere tinteggiato
- Foro per installazione suggerito: \varnothing 110 mm

- Built-in one-light lamp for plasterboard with black varnished metal frame
- For GU10 bulbs
- Bulbs: halogen, fluorescent, LED
- After chalk finishing the plasterboard, the lamp built-in becomes an integral part of the wall and can be painted
- Recommended installation hole: \varnothing 110 mm

- Einbauleuchte für Gipskarton mit einem Leuchtmittel und schwarz lackiertem Metallrahmen
- Für Leuchtmittel mit GU10 Fassung
- installierbare Leuchtmittel: Halogen, Leuchtstoff, LED
- Nachdem der Gipskarton glatt verputzt wurde, wird die Einbauleuchte zu einem integrierenden Bestandteil der Mauer und kann gestrichen werden
- Empfohlene Einbauöffnung: \varnothing 110 mm

- Luminaria de empotrar, para cartón yeso, con una luz, con marco metálico pintado de negro
- Para lámparas GU10
- Lámparas que se pueden instalar: halógenas, fluorescentes, LED
- Después de haber enrasado con yeso el cartón yeso el empotrado forma parte integrante de la pared y se puede pintar
- Orificio para instalación aconsejado: \varnothing 110 mm

- Встраиваемый светильник для гипсокартона с одной лампочкой и металлической рамой, окрашенной в чёрный цвет
- Лампы с цоколем GU10
- Применяемые лампочки: галогенные, флуоресцентные, светодиодные
- После выравнивания гипсокартона гипсом встраиваемый светильник становится неотъемлемой частью стены и можно его покрасить
- Рекомендуемое монтажное отверстие: \varnothing 110 mm

Omologazioni

CE V □

Type-approvals

CE V □

Zulassungen

CE V □

Homologaciones

CE V □

Омологации

CE V □

T332



- GU10
- 1x40W

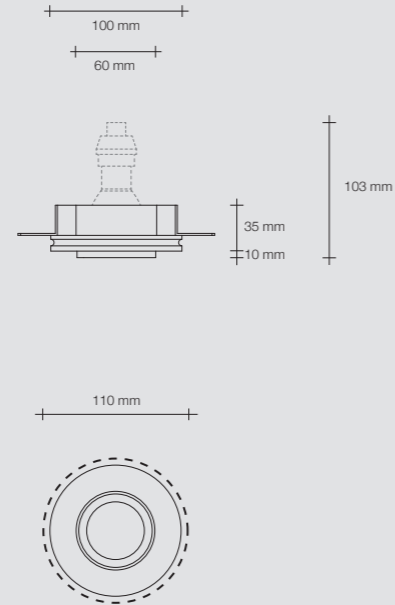

Ingombro complessivo di lampada con altezza indicativa di 50 mm e portalampada fornito

Overall lamp (approx. 50 mm high) and lamp holder (supplied) size

Gesamtabmessungen einschließlich Lampe mit einer ungefähren Höhe von 50 mm und mitgelieferter Lampenfassung

Medidas con lámpara con altura indicativa de 50 mm y portalámparas incluido

Габариты включают лампы высотой примерно 50 мм и входящий в комплект поставки цоколь

Ø 110 mm

Foro per installazione suggerito
Recommended installation hole
Empfohlene Einbauöffnung
Orificio para instalación aconsejado
Рекомендуемое монтажное отверстие







- Lampada a incasso per cartongesso ad una luce con cornice metallica verniciata bianca
- Per lampadine GU10
- Lampadine installabili: alogene, fluorescenti, led
- Dopo aver rasato a gesso il cartongesso l'incasso risulta parte integrante del muro stesso e può essere tinteggiato
- Foro per installazione suggerito: \varnothing 110 mm

- Built-in one-light lamp for plasterboard with white varnished metal frame
- For GU10 bulbs
- Bulbs: halogen, fluorescent, LED
- After chalk finishing the plasterboard, the lamp built-in becomes an integral part of the wall and can be painted
- Recommended installation hole: \varnothing 110 mm

- Einbauleuchte für Gipskarton mit einem Leuchtmittel und weiß lackiertem Metallrahmen
- Für Leuchtmittel mit GU10 Fassung
- installierbare Leuchtmittel: Halogen, Leuchtstoff, LED
- Nachdem der Gipskarton glatt verputzt wurde, wird die Einbauleuchte zu einem integrierenden Bestandteil der Mauer und kann gestrichen werden
- Empfohlene Einbauöffnung: \varnothing 110 mm

- Luminaria de empotrar, para cartón yeso, con una luz, con marco metálico pintado de blanco
- Para lámparas GU10
- Lámparas que se pueden instalar: halógenas, fluorescentes, LED
- Después de haber enrasado con yeso el cartón yeso el empotrado forma parte integrante de la pared y se puede pintar
- Orificio para instalación aconsejado: \varnothing 110 mm

- Встраиваемый светильник для гипсокартона с одной лампочкой и металлической рамой, окрашенной в белый цвет
- Лампы с цоколем GU10
- Применяемые лампочки: галогенные, флуоресцентные, светодиодные
- После выравнивания гипсокартона гипсом встраиваемый светильник становится неотъемлемой частью стены и можно его покрасить
- Рекомендуемое монтажное отверстие: \varnothing 110 мм

Omologazioni



Type-approvals



Zulassungen



Homologaciones



Омологации



T334



- GU10
- 1x40W

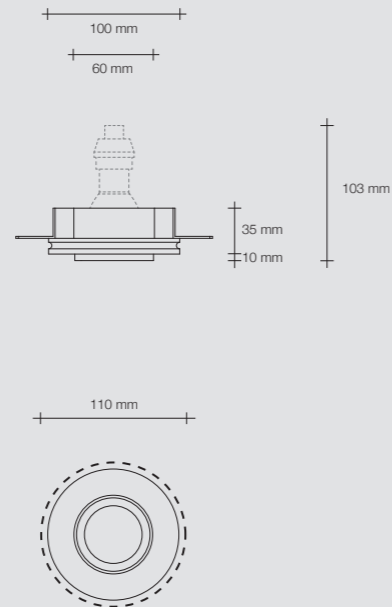

Ingombro complessivo di lampada con altezza indicativa di 50 mm e portalampada fornito

Overall lamp (approx. 50 mm high) and lamp holder (supplied) size

Gesamtabmessungen einschließlich Lampe mit einer ungefähren Höhe von 50 mm und mitgelieferter Lampenfassung

Medidas con lámpara con altura indicativa de 50 mm y portalámparas incluido

Габариты включают лампы высотой примерно 50 мм и входящий в комплект поставки цоколь

\varnothing 110 mm

Foro per installazione suggerito
Recommended installation hole
Empfohlene Einbauöffnung
Orificio para instalación aconsejado
Рекомендуемое монтажное отверстие





THESSALY



- Lampada a incasso per cartongesso ad una luce con cornice metallica con finitura oro spazzolato
- Per lampadine GU10
- Lampadine installabili: alogene, fluorescenti, led
- Dopo aver rasato a gesso il cartongesso l'incasso risulta parte integrante del muro stesso e può essere tinteggiato
- Foro per installazione suggerito: \varnothing 110 mm

- Built-in one-light lamp for plasterboard with brushed gold finish metal frame
- For GU10 bulbs
- Bulbs: halogen, fluorescent, LED
- After chalk finishing the plasterboard, the lamp built-in becomes an integral part of the wall and can be painted
- Recommended installation hole: \varnothing 110 mm

- Einbauleuchte für Gipskarton mit einem Leuchtmittel und Metallrahmen mit Oberflächenfinish Gold gebürstet
- Für Leuchtmittel mit GU10 Fassung
- installierbare Leuchtmittel: Halogen, Leuchtstoff, LED
- Nachdem der Gipskarton glatt verputzt wurde, wird die Einbauleuchte zu einem integrierenden Bestandteil der Mauer und kann gestrichen werden
- Empfohlene Einbauöffnung: \varnothing 110 mm

- Luminaria de empotrar, para cartón yeso, con una luz, con marco metálico con acabado oro cepillado
- Para lámparas GU10
- Lámparas que se pueden instalar: halógenas, fluorescentes, LED
- Después de haber enrasado con yeso el cartón yeso el empotrado forma parte integrante de la pared y se puede pintar
- Orificio para instalación aconsejado: \varnothing 110 mm

- Встраиваемый светильник для гипсокартона с одной лампочкой и рамой с отделкой из брашированного металла под золото
- Лампы с цоколем GU10
- Применяемые лампочки: галогенные, флуоресцентные, светодиодные
- После выравнивания гипсокартона гипсом встраиваемый светильник становится неотъемлемой частью стены и можно его покрасить
- Рекомендуемое монтажное отверстие: \varnothing 110 mm

Omologazioni

CE

Type-approvals

CE

Zulassungen

CE

Homologaciones

CE

Омологации

CE

T335



- GU10
- 1x40W

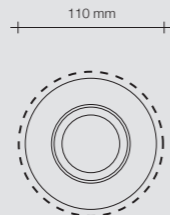
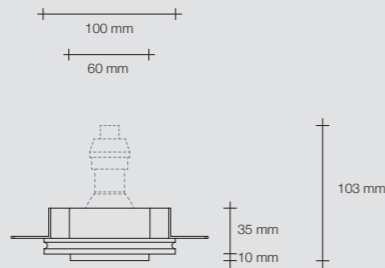

Ingombro comprensivo di lampada con altezza indicativa di 50 mm e portalampana fornito

Overall lamp (approx. 50 mm high) and lamp holder (supplied) size

Gesamtabmessungen einschließlich Lampe mit einer ungefähren Höhe von 50 mm und mitgelieferter Lampenfassung

Medidas con lámpara con altura indicativa de 50 mm y portálamparas incluido

Габариты включают лампу высотой примерно 50 мм и входящий в комплект поставки цоколь

\varnothing 110 mm

Foro per installazione suggerito
Recommended installation hole
Empfohlene Einbauöffnung
Orificio para instalación aconsejado
Рекомендуемое монтажное отверстие





THESSALY



- Lampada a incasso per cartongesso ad una luce con cornice metallica con finitura rame spazzolato
- Per lampadine GU10
- Lampadine installabili: alogene, fluorescenti, led
- Dopo aver rasato a gesso il cartongesso l'incasso risulta parte integrante del muro stesso e può essere tinteggiato
- Foro per installazione suggerito: \varnothing 110 mm

- Built-in one-light lamp for plasterboard with brushed copper finish metal frame
- For GU10 bulbs
- Bulbs: halogen, fluorescent, LED
- After chalk finishing the plasterboard, the lamp built-in becomes an integral part of the wall and can be painted
- Recommended installation hole: \varnothing 110 mm

- Einbauleuchte für Gipskarton mit einem Leuchtmittel und Metallrahmen mit Oberflächenfinish Kupfer gebürstet
- Für Leuchtmittel mit GU10 Fassung
- installierbare Leuchtmittel: Halogen, Leuchtstoff, LED
- Nachdem der Gipskarton glatt verputzt wurde, wird die Einbauleuchte zu einem integrierenden Bestandteil der Mauer und kann gestrichen werden
- Empfohlene Einbauöffnung: \varnothing 110 mm

- Luminaria de empotrar, para cartón yeso, con una luz, con marco metálico con acabado oro cepillado
- Para lámparas GU10
- Lámparas que se pueden instalar: halógenas, fluorescentes, LED
- Después de haber enrasado con yeso el cartón yeso el empotrado forma parte integrante de la pared y se puede pintar
- Orificio para instalación aconsejado: \varnothing 110 mm

- Встраиваемый светильник для гипсокартона с одной лампочкой и металлической рамой с отделкой из брашированной меди
- Лампы с цоколем GU10
- Применяемые лампочки: галогенные, флуоресцентные, светодиодные
- После выравнивания гипсокартона гипсов встраиваемый светильник становится неотъемлемой частью стены и можно его покрасить
- Рекомендуемое монтажное отверстие: \varnothing 110 mm

Omologazioni

CE  

Type-approvals

CE  

Zulassungen

CE  

Homologaciones

CE  

Омологации

CE  

T336



- GU10
- 1x40W

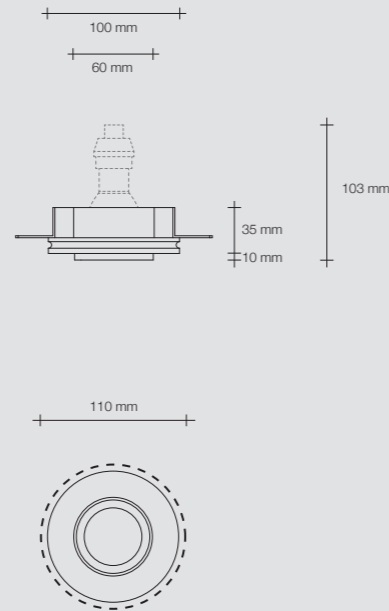

Ingombro comprensivo di lampada con altezza indicativa di 50 mm e portalampada fornito

Overall lamp (approx. 50 mm high) and lamp holder (supplied) size

Gesamtabmessungen einschließlich Lampe mit einer ungefähren Höhe von 50 mm und mitgelieferter Lampenfassung

Medidas con lámpara con altura indicativa de 50 mm y portalámparas incluido

Габариты включают лампу высотой примерно 50 мм и входящий в комплект поставки цоколь

Ø 110 mm

Foro per installazione suggerito
Recommended installation hole
Empfohlene Einbauöffnung
Orificio para instalación aconsejado
Рекомендуемое монтажное отверстие

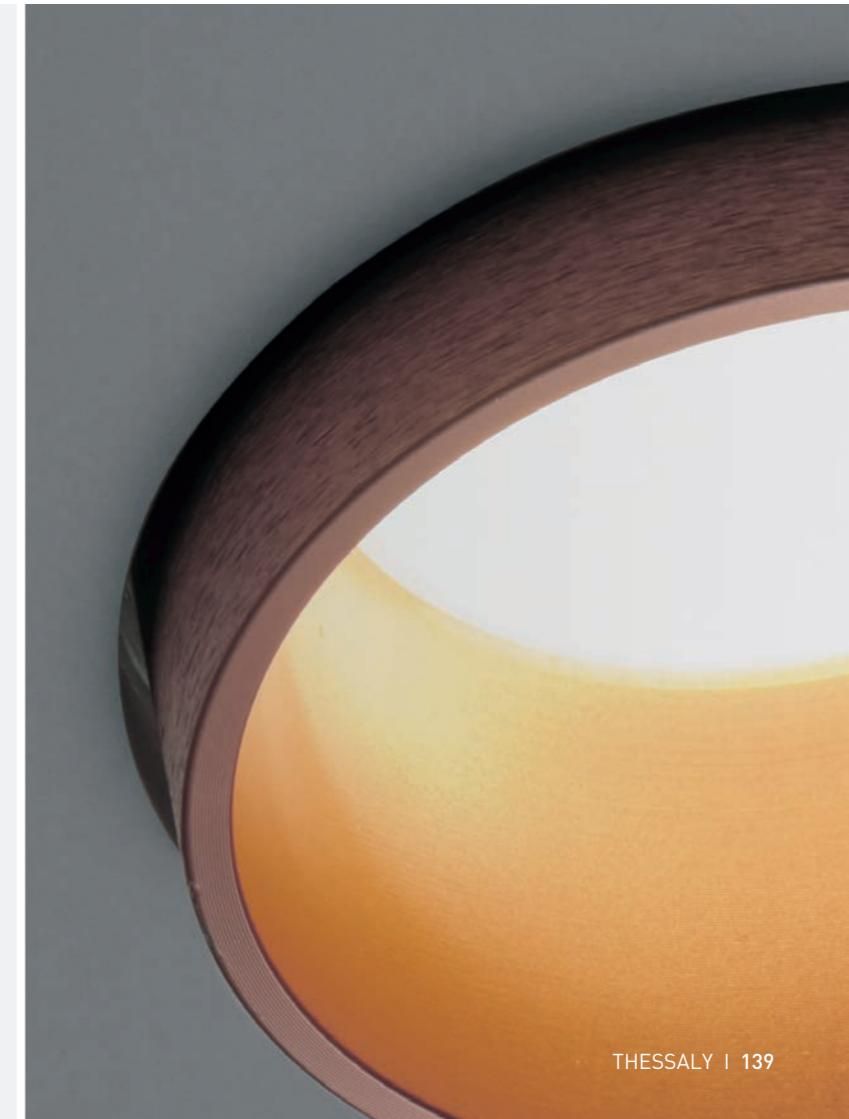
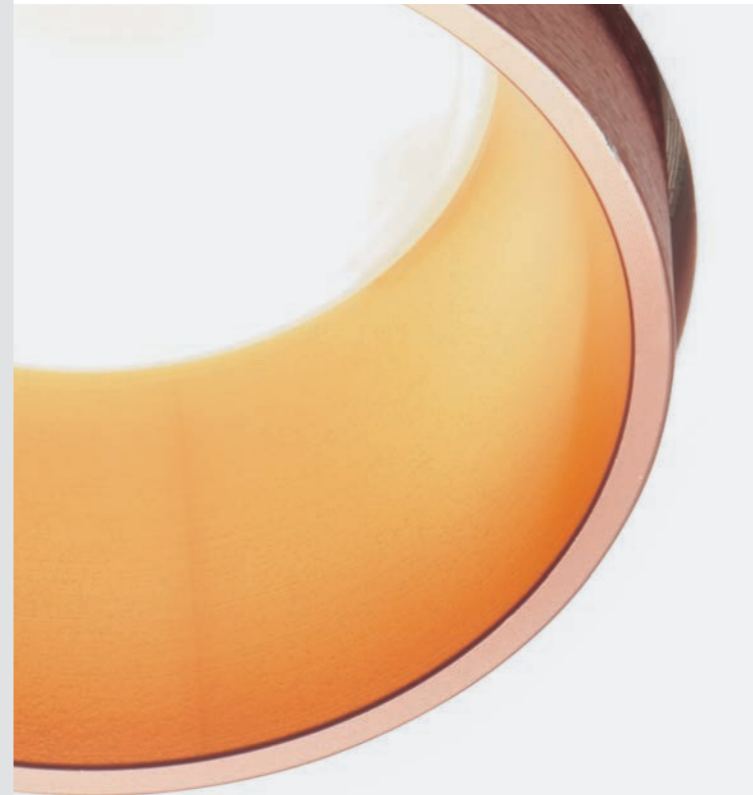



LELANTO



- Lampada a incasso per cartongesso ad una luce orientabile
- Per lampadine GU10
- Lampadine installabili: alogene, fluorescenti, led
- Dopo aver rasato a gesso il cartongesso l'incasso risulta parte integrante del muro stesso e può essere tinteggiato
- Foro per installazione suggerito: Ø 110 mm

- One-light adjustable recessed plasterboard lamp
- For GU10 bulbs
- The following bulbs can be installed: halogen, fluorescent, LED
- After smoothening the plasterboard with plaster, the recess is an integral part of the wall and can be painted
- Recommended installation hole: Ø 110 mm

- Einbauleuchte für Gipskarton mit einem Leuchtmittel
- Für Leuchtmittel mit GU10 Fassung
- installierbare Leuchtmittel: Halogen, Leuchtstoff, LED
- Nachdem der Gipskarton glatt verputzt wurde, wird die Einbauleuchte zu einem integrierenden Bestandteil Wand und kann gestrichen werden
- Empfohlene Einbauöffnung: Ø 110 mm

- Luminaria de empotrar, para cartón yeso con una luz orientable
- Para lámparas GU10
- Lámparas que se pueden instalar: halógenas, fluorescentes, LED
- Después de haber enrasado con yeso el cartón yeso el empotrado forma parte integrante de la pared y se puede pintar
- Orificio para instalación aconsejado: Ø 110 mm

- Встроенный светильник для гипсокартона с регулируемым источником света
- Для лампочек GU10
- Устанавливаемые лампочки: галогенные, флуоресцентные, светодиодные
- После обработки гипсокартона до гипса рамка выглядит как неотъемлемая составляющая стены и может быть окрашена
- Рекомендуемое монтажное отверстие: Ø 110 mm

Omologazioni

CE V D

Type-approvals

CE V D

Zulassungen

CE V D

Homologaciones

CE V D

Омологации

CE V D

T356



- GU10
- 1x40W

- Orientabile 15°
- Adjustable 15°
- Ausrichtbar 15°
- Orientable 15°
- Регулируемая 15°

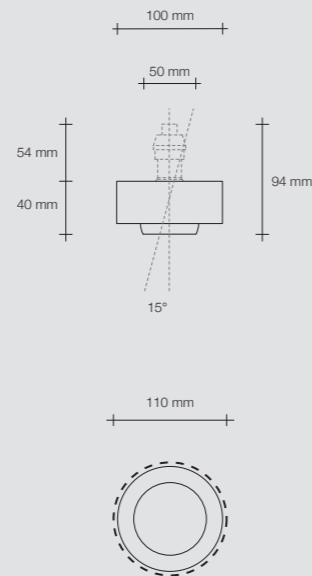

Ingombro comprensivo di lampada con altezza indicativa di 50 mm e portalampana fornito

Overall lamp (approx. 50 mm high) and lamp holder (supplied) size

Gesamtmaße einschließlich Lampe mit einer ungefähren Höhe von 50 mm und mitgelieferter Lampenfassung

Medidas con lámpara con altura indicativa de 50 mm y portálamparas incluido

Габариты включают лампу высотой примерно 50 мм и входящий в комплект поставки цоколь

Ø 110 mm

Foro per installazione suggerito
Recommended installation hole
Empfohlene Einbauöffnung
Orificio para instalación aconsejado
Рекомендуемое монтажное





LELANTO



- Lampada a incasso per cartongesso a due luci orientabili
- Per lampadine GU10
- Lampadine installabili: alogene, fluorescenti, led
- Dopo aver rasato a gesso il cartongesso l'incasso risulta parte integrante del muro stesso e può essere tinteggiato
- Foro per installazione suggerito: 210 x 110 mm

- Two-light adjustable recessed plasterboard lamp
- For GU10 bulbs
- The following bulbs can be installed: halogen, fluorescent, LED
- After smoothening the plasterboard with plaster, the recess is an integral part of the wall and can be painted
- Recommended installation hole: 210 x 110 mm

- Einbauleuchte für Gipskarton mit zwei ausrichtbaren Leuchtmitteln
- Für Leuchtmittel mit GU10 Fassung
- installierbare Leuchtmittel: Halogen, Leuchtstoff, LED
- Nachdem der Gipskarton glatt verputzt wurde, wird die Einbauleuchte zu einem integrierenden Bestandteil Wand und kann gestrichen werden
- Empfohlene Einbauöffnung: 210 x 110 mm

- Luminaria de empotrar, para cartón yeso con dos luces orientables
- Para lámparas GU10
- Lámparas que se pueden instalar: halógenas, fluorescentes, LED
- Después de haber enrasado con yeso el cartón yeso el empotrado forma parte integrante de la pared y se puede pintar
- Orificio para instalación aconsejado: 210 x 110 mm

- Встроенный светильник для гипсокартона с двумя регулируемые источниками света
- Для лампочек GU10
- Устанавливаемые лампочки: галогенные, флюоресцентные, светодиодные
- После обработки гипсокартона до гиса рамка выглядит как неотъемлемая составляющая стены и может быть окрашена
- Рекомендуемое монтажное отверстие: 210 x 110 mm

Omologazioni

CE V D

Type-approvals

CE V D

Zulassungen

CE V D

Homologaciones

CE V D

Омологации

CE V D

T357



- GU10
- 2x40W

- Orientabile 15°
- Adjustable 15°
- Ausrichtbar 15°
- Orientable 15°
- Регулируемая 15°

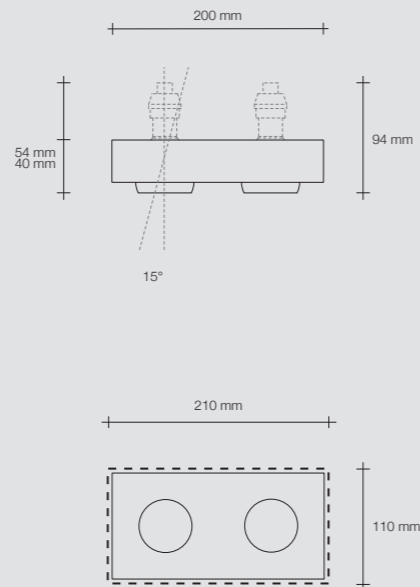

Ingombro comprensivo di lampada con altezza indicativa di 50 mm e portalampana fornito

Overall lamp (approx. 50 mm high) and lamp holder (supplied) size

Gesamtmaße einschließlich Lampe mit einer ungefähren Höhe von 50 mm und mitgelieferter Lampenfassung

Medidas con lámpara con altura indicativa de 50 mm y portálamparas incluido

Габариты включают лампы высотой примерно 50 мм и входящий в комплект поставки цоколь

210 x 110 mm

Foro per installazione suggerito
Recommended installation hole
Empfohlene Einbauöffnung
Orificio para instalación aconsejado
Рекомендуемое монтажное







- Lampada a incasso per cartongesso ad una luce
- Per lampadine GU10
- Lampadine installabili: alogene, fluorescenti, led
- Grado di protezione IP44
- Dopo aver rasato a gesso il cartongesso l'incasso risulta parte integrante del muro stesso e può essere tinteggiato
- Foro per installazione suggerito: Ø 140 mm

- One-light recessed plasterboard lamp
- For GU10 bulbs
- The following bulbs can be installed: halogen, fluorescent, LED
- Degree of protection: IP44
- After smoothing the plasterboard with plaster, the recess is an integral part of the wall and can be painted
- Recommended installation hole: Ø 140 mm

- Einbauleuchte für Gipskarton mit einem Leuchtmittel
- Für Leuchtmittel mit GU10 Fassung
- installierbare Leuchtmittel: Halogen, Leuchtstoff, LED
- Schutzart IP44
- Nachdem der Gipskarton glatt verputzt wurde, wird die Einbauleuchte zu einem integrierenden Bestandteil der Wand und kann gestrichen werden
- Empfohlene Einbauöffnung: Ø 140 mm

- Luminaria de empotrar, para cartón yeso con una luz
- Para lámparas GU10
- Lámparas que se pueden instalar: halógenas, fluorescentes, LED
- Grado de protección IP44
- Después de haber enrasado con yeso el cartón yeso forma parte integrante de la pared y se puede pintar
- Orificio para instalación aconsejado: Ø 140 mm

- Встроенный светильник для гипсокартона с одним источником света
- Для лампочек GU10
- Устанавливаемые лампочки: галогенные, флюоресцентные, светодиодные
- Уровень защиты IP44
- После обработки гипсокартона до гипса рамка выглядит как неотъемлемая составляющая стены и может быть окрашена
- Рекомендуемое монтажное отверстие: Ø 140 mm

Omologazioni

CE V D

Type-approvals

CE V D

Zulassungen

CE V D

Homologaciones

CE V D

Омологации

CE V D

T353



- GU10
- 1 x 40W

- Grado di protezione IP44
- Degree of protection: IP44
- Schutzart IP44
- Grado de protección IP44
- Уровень защиты IP44

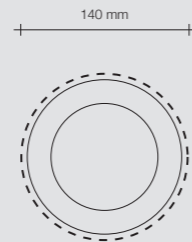
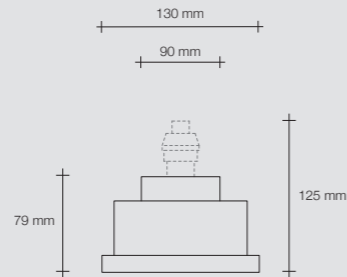

Ingombro complessivo di lampada con altezza indicativa di 50 mm e portalampada fornito

Overall lamp (approx. 50 mm high) and lamp holder (supplied) size

Gesamtmaße einschließlich Lampe mit einer ungefähren Höhe von 50 mm und mitgelieferter Lampenfassung

Medidas con lámpara con altura indicativa de 50 mm y portalámparas incluido

Габариты включают лампу высотой примерно 50 мм и входящий в комплект поставки цоколь

Ø 140 mm

Foro per installazione suggerito

Recommended installation hole

Empfohlene Einbauöffnung

Orificio para instalación aconsejado

Рекомендуемое монтажное отверстие

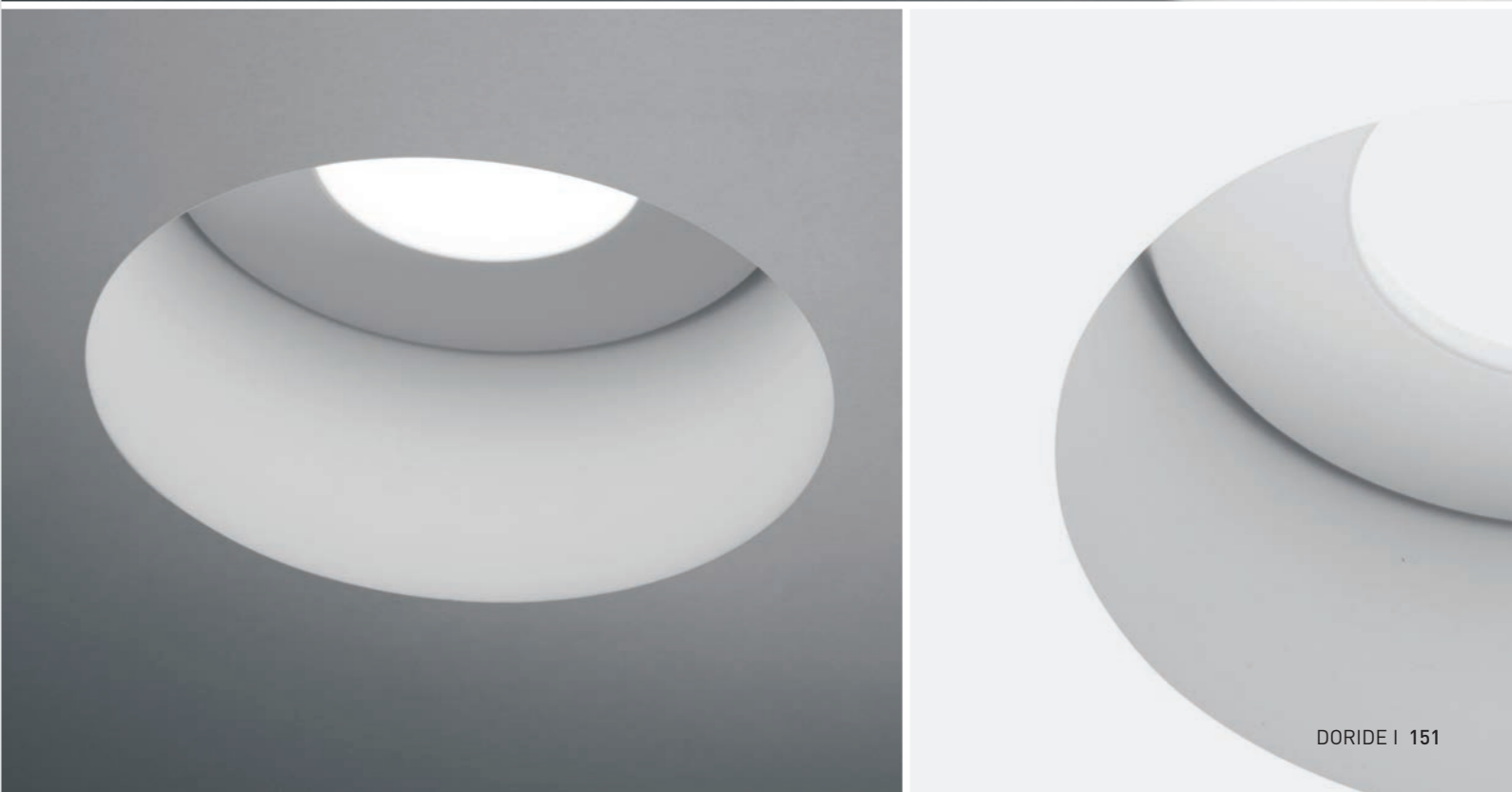



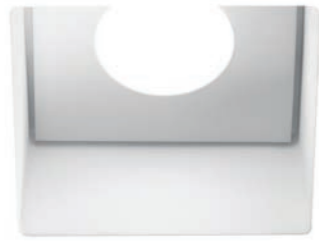

- Lampada a incasso per cartongesso ad una luce
- Per lampadine GU10
- Lampadine installabili: alogene, fluorescenti, led
- Grado di protezione IP44
- Dopo aver rasato a gesso il cartongesso l'incasso risulta parte integrante del muro stesso e può essere tinteggiato
- Foro per installazione suggerito: 140 x 140 mm

- One-light recessed plasterboard lamp
- For GU10 bulbs
- The following bulbs can be installed: halogen, fluorescent, LED
- Degree of protection: IP44
- After smoothing the plasterboard with plaster, the recess is an integral part of the wall and can be painted
- Recommended installation hole: 140 x 140 mm

- Einbauleuchte für Gipskarton mit einem Leuchtmittel
- Für Leuchtmittel mit GU10 Fassung
- installierbare Leuchtmittel: Halogen, Leuchtstoff, LED
- Schutzart IP44
- Nachdem der Gipskarton glatt verputzt wurde, wird die Einbauleuchte zu einem integrierenden Bestandteil der Wand und kann gestrichen werden
- Empfohlene Einbauöffnung: 140 x 140 mm

- Luminaria de empotrar, para cartón yeso con una luz
- Para lámparas GU10
- Lámparas que se pueden instalar: halógenas, fluorescentes, LED
- Grado de protección IP44
- Después de haber enrasado con yeso el cartón yeso forma parte integrante de la pared y se puede pintar
- Orificio para instalación aconsejado: 140 x 140 mm

- Встроенный светильник для гипсокартона с одним источником света
- Для лампочек GU10
- Устанавливаемые лампочки: галогенные, флюоресцентные, светодиодные
- Уровень защиты IP44
- После обработки гипсокартона до гипса рамка выглядит как неотъемлемая составляющая стены и может быть окрашена
- Рекомендуемое монтажное отверстие: 140 x 140 mm

Omologazioni

CE V D

Type-approvals

CE V D

Zulassungen

CE V D

Homologaciones

CE V D

Омологации

CE V D

T354



- GU10
- 1 x 40W

- Grado di protezione IP44
- Degree of protection: IP44
- Schutzart IP44
- Grado de protección IP44
- Уровень защиты IP44

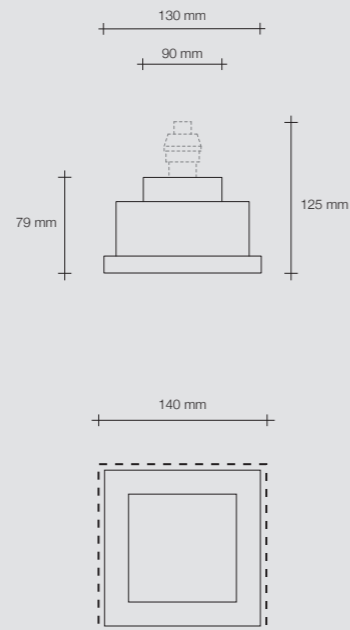

Ingombro comprensivo di lampada con altezza indicativa di 50 mm e portalamпада fornito

Overall lamp (approx. 50 mm high) and lamp holder (supplied) size

Gesamtabmessungen einschließlich Lampe mit einer ungefähren Höhe von 50 mm und mitgelieferter Lampenfassung

Medidas con lámpara con altura indicativa de 50 mm y portálámparas incluido

Габариты включают лампу высотой примерно 50 мм и входящий в комплект поставки цоколь

140 x 140 mm

Foro per installazione suggerito
Recommended installation hole
Empfohlene Einbauöffnung
Orificio para instalación aconsejado
Рекомендуемое монтажное

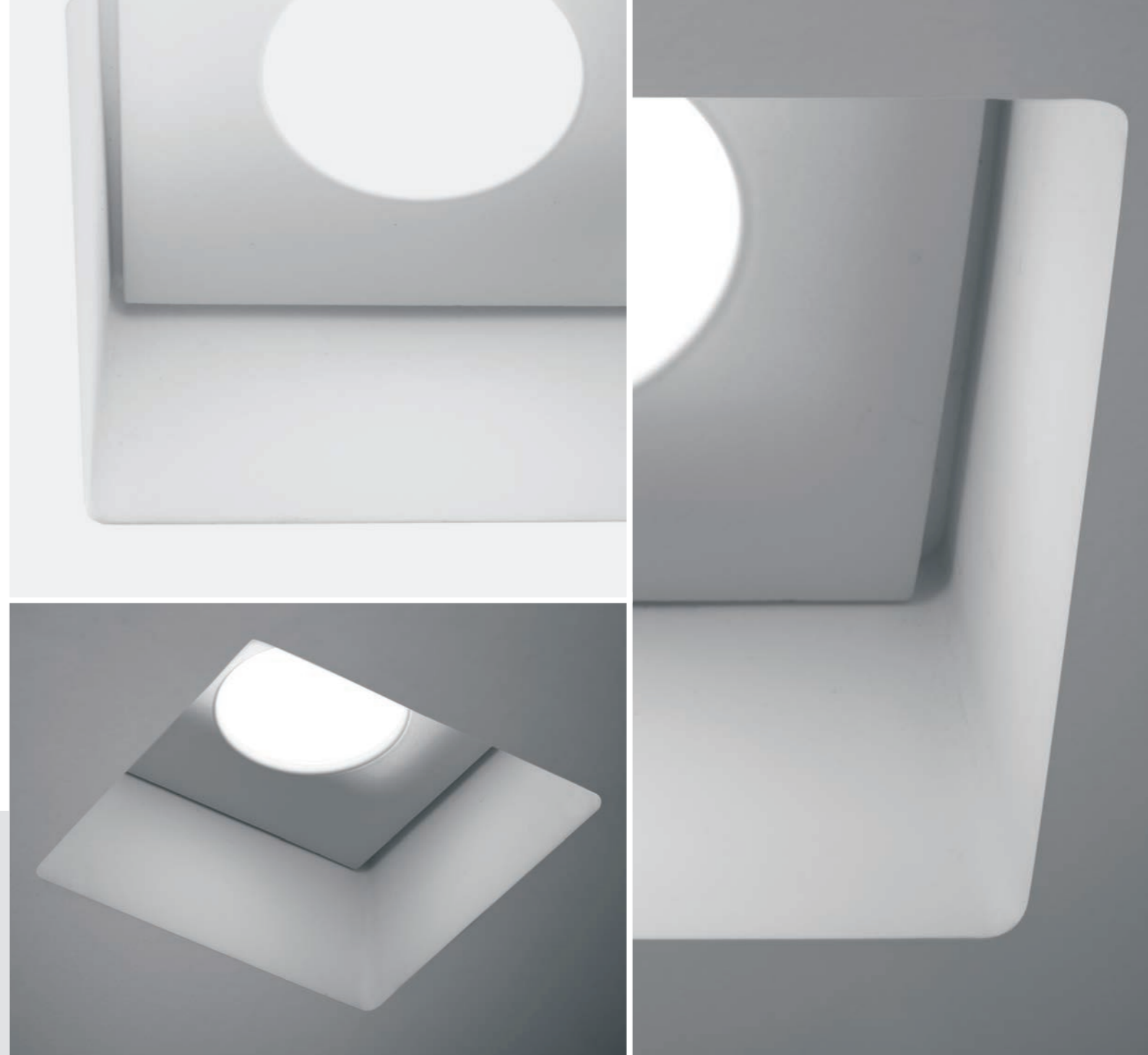





Incasso invisibile per controsoffitti a due luci in un blocco. Dopo aver rasato a gesso il controsoffitto, l'incasso risulta parte integrante del soffitto stesso e può essere tinteggiato.

- Apertura per installazione: 190x250 mm.
- Peso Kg. 2,1
- Foro per installazione suggerito: 252 x 192 mm

Concealed recessed fitting for false ceilings with two lights in a single block. Once the false ceiling has been plastered, the recessed fitting will become an integral part of the ceiling and can be painted.

- Opening required for installation: 190x250 mm.
- Weight Kg. 2,1
- Recommended installation hole: 252 x 192 mm

Nicht sichtbarer Einbau für abgehängte Decken mit zwei Leuchten in einem Block. Nachdem die abgehängte Decke glatt verputzt wurde, wird die Einbauleuchte zu einem integrierenden Bestandteil der Decke und kann gestrichen werden.

- Öffnung zur Installation: 190x250 mm.
- Gewicht Kg. 2,1
- Empfohlene Einbauöffnung: 252 x 192 mm

Empotrado invisible para falsos techos de dos luces en un bloque. Después de haber enrasado el falso techo, el empotrado forma parte integrante del techo y se puede pintar.

- Abertura para efectuar la instalación: 190x250 mm.
- Peso Kg. 2,1
- Orificio para instalación aconsejado: 252 x 192 mm

Встраиваемый невидимый светильник для подвесных потолков с двумя источниками света в одном корпусе. После нанесения гипсовой штукатурки на подвесной потолок, установленный светильник будет неотъемлемой частью потолка и можно будет его покрасить.

- Размер отверстия для установки: 190x250 mm.
- Вес кг 2,1
- Рекомендуемое монтажное отверстие: 252 x 192 mm

Omologazioni
CE V

Type-approvals
CE V

Zulassungen
CE V

Homologaciones
CE V

Омологации
CE V

T255



- GU10
- 2x40W

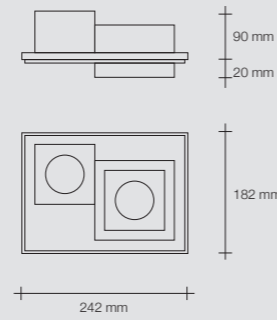

252 x 192 mm
Foro per installazione suggerito
Recommended installation hole
Empfohlene Einbauöffnung
Orificio para instalación aconsejado
Рекомендуемое монтажное отверстие

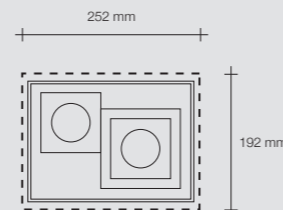





Incasso invisibile per controsoffitti a tre luci in un blocco.
Dopo aver rasato a gesso il controsoffitto, l'incasso risulta parte integrante del soffitto stesso e può essere tinteggiato.
- Apertura per installazione: 240x290 mm.
- Peso Kg. 2,8
- Foro per installazione suggerito: 292 x 244 mm

Concealed recessed fitting for false ceilings with three lights in a single block. Once the false ceiling has been plastered, the recessed fitting will become an integral part of the ceiling and can be painted.
- Opening required for installation: 240x290 mm.
- Weight Kg. 2,8
- Recommended installation hole: 292 x 244 mm

Nicht sichtbarer Einbau für abgehängte Decken mit drei Leuchten in einem Block. Nachdem die abgehängte Decke glatt verputzt wurde, wird die Einbauleuchte zu einem integrierenden Bestandteil der Decke und kann gestrichen werden.
- Öffnung zur Installation: 240x290 mm.
- Gewicht Kg. 2,8
- Empfohlene Einbauöffnung: 292 x 244 mm

Empotrado invisible para falsos techos de tres luces en un bloque. Después de haber enrasado el falso techo, el empotrado forma parte integrante del techo y se puede pintar.
- Abertura para efectuar la instalación: 240x290 mm.
- Peso Kg. 2,8
- Orificio para instalación aconsejado: 292 x 244 mm

Встраиваемый невидимый светильник для подвесных потолков с тремя источниками света в одном корпусе. После нанесения гипсовой штукатурки на подвесной потолок, установленный светильник будет неотъемлемой частью потолка и можно будет его покрасить.
- Размер отверстия для установки: 240x290 мм.
- Вес кг 2,8
- Рекомендуемое монтажное отверстие: 292 x 244 мм

Omologazioni
CE V ⊕

Type-approvals
CE V ⊕

Zulassungen
CE V ⊕

Homologaciones
CE V ⊕

Омологации
CE V ⊕

T256



- GU10
- 3x40W

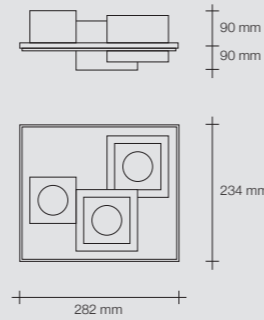

292 x 244 mm
Foro per installazione suggerito
Recommended installation hole
Empfohlene Einbauöffnung
Orificio para instalación aconsejado
Рекомендуемое монтажное отверстие

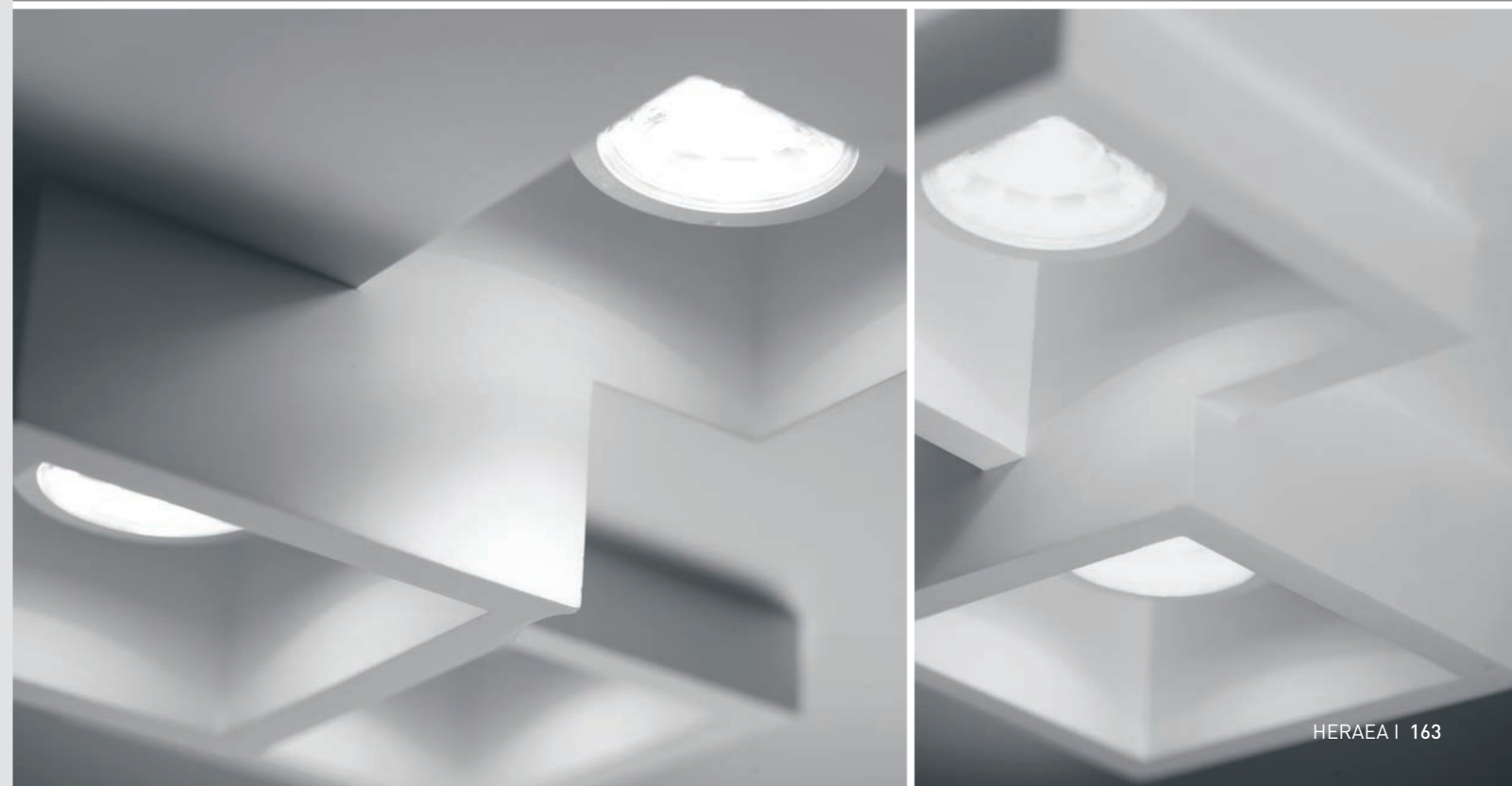
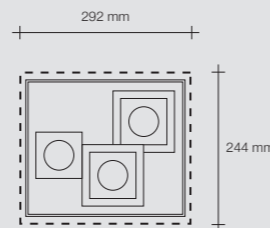



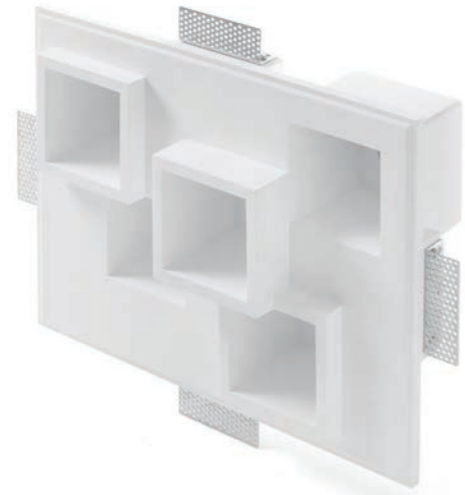

Incasso invisibile per controsoffitti a cinque luci in un blocco.
Dopo aver rasato a gesso il controsoffitto, l'incasso risulta parte integrante del soffitto stesso e può essere tinteggiato.
- Apertura per installazione: 250x380 mm.
- Peso Kg. 3,8
- Foro per installazione suggerito: 380 x 290 mm

Concealed recessed fitting for false ceilings with five lights in a single block. Once the false ceiling has been plastered, the recessed fitting will become an integral part of the ceiling and can be painted.
- Opening required for installation: 250x380 mm.
- Weight Kg. 3,8
- Recommended installation hole: 380 x 290 mm

Nicht sichtbarer Einbau für abgehängte Decken mit fünf Leuchten in einem Block. Nachdem die abgehängte Decke glatt verputzt wurde, wird die Einbauleuchte zu einem integrierenden Bestandteil der Decke und kann gestrichen werden.
- Öffnung zur Installation: 250x380 mm.
- Gewicht Kg. 3,8
- Empfohlene Einbauöffnung: 380 x 290 mm

Empotrado invisible para falsos techos de cinco luces en un bloque. Después de haber enrasado el falso techo, el empotrado forma parte integrante del techo y se puede pintar.
- Abertura para efectuar la instalación: 250x380 mm.
- Peso Kg. 3,8
- Orificio para instalación aconsejado: 380 x 290 mm

Встраиваемый невидимый светильник для подвесных потолков с пятью источниками света в одном корпусе. После нанесения гипсовой штукатурки на подвесной потолок, установленный светильник будет неотъемлемой частью потолка и можно будет его покрасить.
- Размер отверстия для установки: 250x380 мм.
- Вес кг 3,8
- Рекомендуемое монтажное отверстие: 380 x 290 мм

Omologazioni
CE V ⊕

Type-approvals
CE V ⊕

Zulassungen
CE V ⊕

Homologaciones
CE V ⊕

Омологации
CE V ⊕



T257



- GU10
- 5x40W

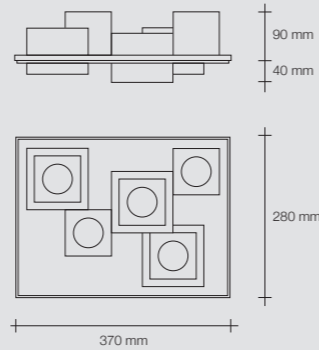

380 x 290 mm
Foro per installazione suggerito
Recommended installation hole
Empfohlene Einbauöffnung
Orificio para instalación aconsejado
Рекомендуемое монтажное отверстие

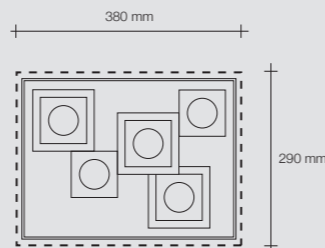





Lampada in gesso da incasso invisibile per cartongessi. Dopo aver rasato, l'incasso risulta parte integrante del muro stesso e può essere tinteggiato.
 - Apertura per installazione 22,5x10,5
 - Foro per installazione suggerito: 225 x 100 mm

Concealed recessed light in plaster for installation in plasterboard. Once the wall has been plastered, the recessed fitting will become an integral part of the wall and can be painted.
 - Opening required for installation 22,5x10,5
 - Recommended installation hole: 225 x 100 mm

Nicht sichtbare Gips-Einbauleuchte für Gipskarton. Nachdem alles glatt verputzt wurde, wird die Einbauleuchte zu einem integrierenden Bestandteil der Mauer und kann gestrichen werden.
 - Öffnung zur Installation 22,5x10,5
 - Empfohlene Einbauöffnung: 225 x 100 mm

Lámpara de yeso para empotrar, invisible, para cartón yeso. Después de haber enrasado, el empotrado forma parte integrante de la pared y se puede pintar.
 - Abertura para efectuar la instalación 22,5x10,5
 - Orificio para instalación aconsejado: 225 x 100 mm

Встраиваемый невидимый светильник из гипса для гипсокартона. После нанесения гипсовой штукатурки, установленный светильник будет неотъемлемой частью стены и можно будет его покрасить.
 - Размер отверстия для установки 22,5x10,5
 - Рекомендуемое монтажное отверстие: 225 x 100 mm

Omologazioni
 CE V

Type-approvals
 CE V

Zulassungen
 CE V

Homologaciones
 CE V

Омологации
 CE V

T232



- GU10
 - 3x40W

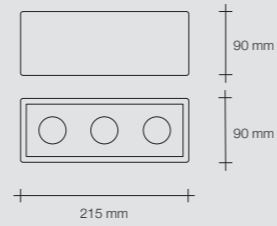

225 x 100 mm
 Foro per installazione suggerito
 Recommended installation hole
 Empfohlene Einbauöffnung
 Orificio para instalación aconsejado
 Рекомендуемое монтажное отверстие

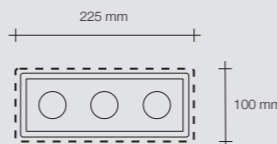



Lampada in gesso da incasso invisibile per cartongessi. Dopo aver rasato, l'incasso risulta parte integrante del muro stesso e può essere tinteggiato.

- Apertura per installazione 36x10,5
- Peso Kg. 2,1
- Foro per installazione suggerito: 356 x 105 mm

Concealed recessed light in plaster for installation in plasterboard. Once the wall has been plastered, the recessed fitting will become an integral part of the wall and can be painted.

- Opening required for installation 36x10,5
- Weight Kg. 2,1
- Recommended installation hole: 356 x 105 mm

Nicht sichtbare Gips-Einbauleuchte für Gipskarton. Nachdem alles glatt verputzt wurde, wird die Einbauleuchte zu einem integrierenden Bestandteil der Mauer und kann gestrichen werden.

- Öffnung zur Installation 36x10,5
- Gewicht Kg. 2,1
- Empfohlene Einbauöffnung: 356 x 105 mm

Lámpara de yeso para empotrar, invisible, para cartón yeso. Después de haber enrasado, el empotrado forma parte integrante de la pared y se puede pintar.

- Abertura para efectuar la instalación 36x10,5
- Peso Kg. 2,1
- Orificio para instalación aconsejado: 356 x 105 mm

Встраиваемый невидимый светильник из гипса для гипсокартона. После нанесения гипсовой штукатурки, установленный светильник будет неотъемлемой частью стены и можно будет его покрасить.

- Размер отверстия для установки 36x10,5
- Вес кг 2,1
- Рекомендуемое монтажное отверстие: 356 x 105 mm

Omologazioni

CE V □

Type-approvals

CE V □

Zulassungen

CE V □

Homologaciones

CE V □

Омологации

CE V □

T233



- GU10
- 5x40W

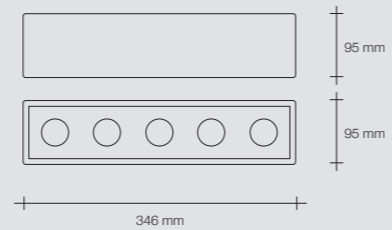

356 x 105 mm
Foro per installazione suggerito
Recommended installation hole
Empfohlene Einbauöffnung
Orificio para instalación aconsejado
Рекомендуемое монтажное отверстие

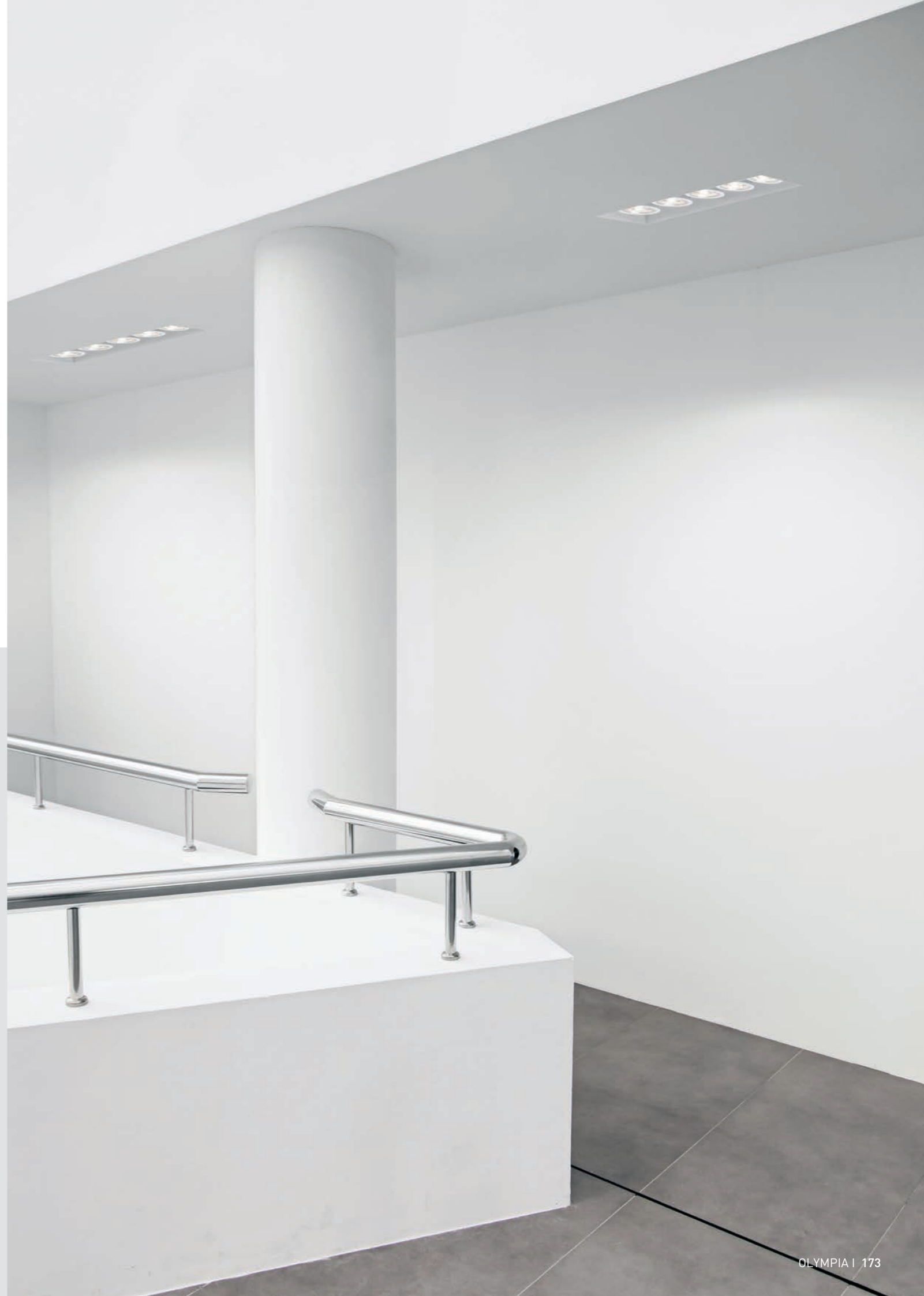
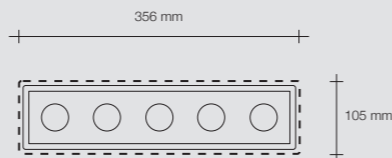



Lampada in gesso da incasso invisibile per cartongessi. Il bordo esterno ne risalta la cornice architettonica. Dopo aver rasato, l'incasso risulta parte integrante del muro stesso e può essere tinteggiato.
 - Apertura per installazione: 25x12,5
 - Foro per installazione suggerito: 250 x 130 mm

Concealed recessed light in plaster for installation in plasterboard. The external border enhances the architectural frame. Once the wall has been plastered, the recessed fitting will become an integral part of the wall and can be painted.
 - Opening required for installation: 25x12.5.
 - Recommended installation hole: 250 x 130 mm

Nicht sichtbare Gips-Einbauleuchte für Gipskarton. Der Außenrand betont und ziert das Umfeld. Nachdem alles glatt verputzt wurde, wird die Einbauleuchte zu einem integrierenden Bestandteil der Mauer und kann gestrichen werden.
 - Öffnung zur Installation 25x12,5
 - Empfohlene Einbauöffnung: 250 x 130 mm

Lámpara de yeso para empotrar, invisible, para cartón yeso. El borde exterior destaca el marco arquitectónico. Después de haber enrasado, el empotrado forma parte integrante de la pared y se puede pintar.
 - Abertura para efectuar la instalación 25x12,5
 - Orificio para instalación aconsejado: 250 x 130 mm

Встраиваемый невидимый светильник из гипса для гипсокартона. Наружный край подчеркивает архитектурную раму. После нанесения гипсовой штукатурки, установленный светильник будет неотъемлемой частью стены и можно будет его покрасить.
 - Размер отверстия для установки 25x12,5
 - Рекомендуемое монтажное отверстие: 250 x 130 mm

Omologazioni
 CE V □

Type-approvals
 CE V □

Zulassungen
 CE V □

Homologaciones
 CE V □

Омологации
 CE V □

T235



- GU10
 - 3x40W

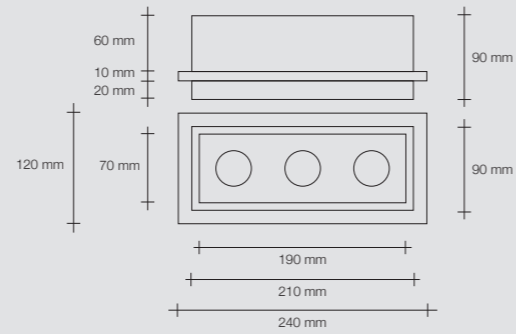

250 x 130 mm
 Foro per installazione suggerito
 Recommended installation hole
 Empfohlene Einbauöffnung
 Orificio para instalación aconsejado
 Рекомендуемое монтажное отверстие

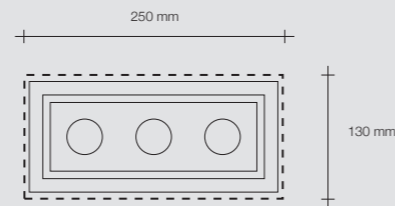



Lampada in gesso da incasso invisibile per cartongessi. Il bordo esterno ne risalta la cornice architettonale. Dopo aver rasato, l'incasso risulta parte integrante del muro stesso e può essere tinteggiato.
 - Apertura per installazione: 38x12,5
 - Peso Kg. 2,8
 - Foro per installazione suggerito: 385 x 130 mm

Concealed recessed light in plaster for installation in plasterboard. The external border enhances the architectural frame. Once the wall has been plastered, the recessed fitting will become an integral part of the wall and can be painted.
 - Opening required for installation: 38x12,5
 - Weight Kg. 2,8
 - Recommended installation hole: 385 x 130 mm

Nicht sichtbare Gips-Einbauleuchte für Gipskarton. Der Außenrand betont und ziert das Umfeld. Nachdem alles glatt verputzt wurde, wird die Einbauleuchte zu einem integrierenden Bestandteil der Mauer und kann gestrichen werden.
 - Öffnung zur Installation 38x12,5
 - Gewicht Kg. 2,8
 - Empfohlene Einbauöffnung: 385 x 130 mm

Lámpara de yeso para empotrar, invisible, para cartón yeso. El borde exterior destaca el marco arquitectónico. Después de haber enrasado, el empotrado forma parte integrante de la pared y se puede pintar.
 - Abertura para efectuar la instalación: 38x12,5
 - Peso Kg. 2,8
 - Orificio para instalación aconsejado: 385 x 130 mm

Встраиваемый невидимый светильник из гипса для гипсокартона. Наружный край подчёркивает архитектурную раму. После нанесения гипсовой штукатурки, установленный светильник будет неотъемлемой частью стены и можно будет его покрасить.
 - Размер отверстия для установки 38x12,5
 - Вес кг 2,8
 - Рекомендуемое монтажное отверстие: 385 x 130 mm

Omologazioni
 CE V □

Type-approvals
 CE V □

Zulassungen
 CE V □

Homologaciones
 CE V □

Омологации
 CE V □

T236



- GU10
 - 5x40W

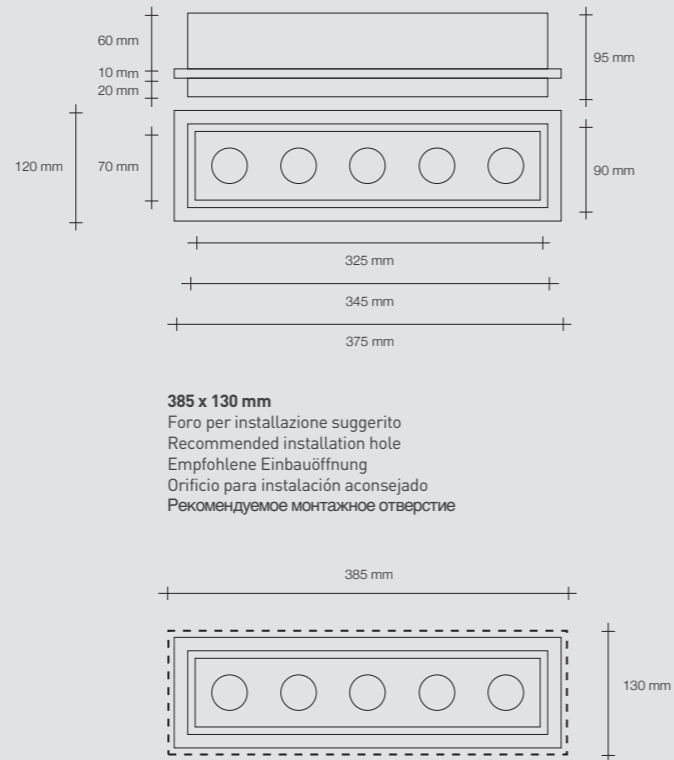





Lampada in gesso da incasso invisibile per cartongessi. Dopo aver rasato a gesso il muro, l'incasso risulta parte integrante del muro stesso e può essere tinteggiato.

- Apertura per installazione Ø 92x92 mm.
- Foro per installazione suggerito: 100 x 100 mm

Recessed light in plaster for plasterboard. Once the wall has been plastered the recessed fitting will become an integral part of the wall and can be painted.

- Opening required for installation: Ø 92x92 mm.
- Recommended installation hole: 100 x 100 mm

Unsichtbar werdende Lampe zum Einlassen aus Gips, für Gipskarton. Nachdem man die Wand gipsverputzt hat, wird der Einsatz zu einem integrierenden Bestandteil der Wand und kann angestrichen werden.

- Installationsöffnung Ø 92x92 mm.
- Empfohlene Einbauöffnung: 100 x 100 mm

Lámpara de yeso empotrada, invisible, para tabiques de cartón yeso. Después de haber enlucido el tabique, el empotrado forma parte integrante de la propia pared y se puede pintar.

- Apertura para la instalación Ø 92x92 mm.
- Orificio para instalación aconsejado: 100 x 100 mm

Гипсовая лампа встраиваемая, невидимая для гипсокартона. После шпаклевки стены, корпус светильника становится составной частью самой стены и можно его окрасить.

- Отверстие для установки Ø 92x92 мм.
- Рекомендуемое монтажное отверстие: 100 x 100 мм

Omologazioni
CE ▽ □ [T170 Ⓢ]

Type-approvals
CE ▽ □ [T170 Ⓢ]

Zulassungen
CE ▽ □ [T170 Ⓢ]

Homologaciones
CE ▽ □ [T170 Ⓢ]

Омологации
CE ▽ □ [T170 Ⓢ]

T165



- GU10
- 1x40W

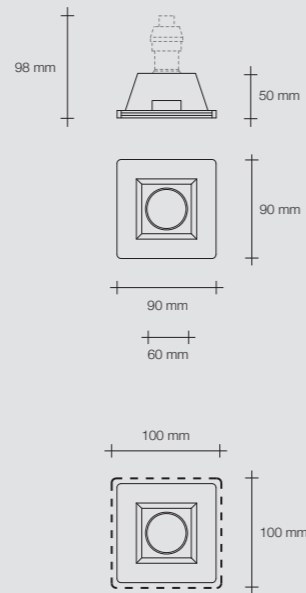

Ingombro comprensivo di lampada con altezza indicativa di 50 mm e portalampada fornito

Overall lamp (approx. 50 mm high) and lamp holder (supplied) size
Gesamtmaße einschließlich Lampe mit einer ungefähren Höhe von 50 mm und mitgelieferter Lampenfassung

Medidas con lámpara con altura indicativa de 50 mm y portalámparas incluido

Габариты включают лампу высотой примерно 50 мм и входящий в комплект поставки цоколь

100 x 100 mm

Foro per installazione suggerito
Recommended installation hole
Empfohlene Einbauöffnung
Orificio para instalación aconsejado
Рекомендуемое монтажное отверстие



SPARTA



- Incasso invisibile per controsoffitti
- Dopo aver rasato a gesso il controsoffitto, l'incasso risulta parte integrante del soffitto stesso e può essere tinteggiato.
- Apertura per installazione Ø 132
- Foro per installazione suggerito: 140 x 140 mm

- Invisible recessed fitting for false ceilings
- Once the false ceiling has been plastered the recessed fitting will become an integral part of the ceiling and can be painted.
- Opening required for installation: Ø 132
- Recommended installation hole: 140 x 140 mm

- Unsichtbarer Einsatz für abgehängte Decken
- Nachdem man die abgehängte Decke gipsverputzt hat, wird der Einsatz zu einem integrierenden Bestandteil der Decke und kann angestrichen werden.
- Installationsöffnung Ø 132
- Empfohlene Einbauöffnung: 140 x 140 mm

- Empotrado invisible para falsos techos
- Después de haber nivelado el falso techo con yeso, el empotrado resulta formar parte integrante del propio techo y se puede pintar.
- Apertura para la instalación Ø 132
- Orificio para instalación aconsejado: 140 x 140 mm

- Скрытый встраиваемый прибор для установки в подвесные потолки
- Оштукатурив потолок гипсовой штукатуркой, встроенный прибор станет неотъемлемой частью самого потолка и можно его покрасить.
- Отверстие для установки Ø 132
- Рекомендуемое монтажное отверстие: 140 x 140 mm

Omologazioni
CE ▽ □ (T102 ◊)

Type-approvals
CE ▽ □ (T102 ◊)

Zulassungen
CE ▽ □ (T102 ◊)

Homologaciones
CE ▽ □ (T102 ◊)

Омологации
CE ▽ □ (T102 ◊)

T93



- GU10
- 1x40W

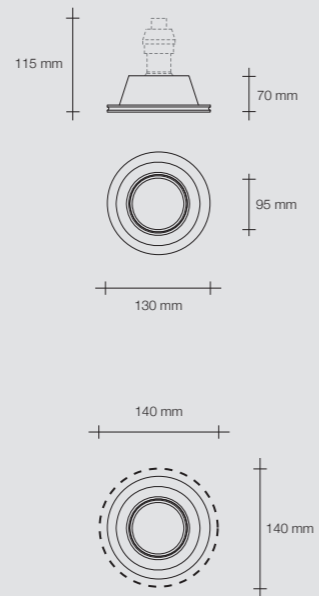

Ingombro comprensivo di lampada con altezza indicativa di 50 mm e portalampada fornito

Overall lamp (approx. 50 mm high) and lamp holder (supplied) size

Gesamtabmessungen einschließlich Lampe mit einer ungefähren Höhe von 50 mm und mitgelieferter Lampenfassung

Medidas con lámpara con altura indicativa de 50 mm y portalámparas incluido

Габариты включают лампу высотой примерно 50 мм и входящий в комплект поставки цоколь

140 x 140 mm

Foro per installazione suggerito

Recommended installation hole

Empfohlene Einbauöffnung

Orificio para instalación aconsejado

Рекомендуемое монтажное отверстие



POLIS

Esempio di prodotto installato e verniciato
Example of fitted and painted product
Beispiel für das installierte und gestrichene Produkt
Ejemplo de producto instalado y pintado
Пример установленного и покрашенного прибора



POLIS



- Incasso invisibile per controsoffitti
- Dopo aver rasato a gesso il controsoffitto, l'incasso risulta parte integrante del soffitto stesso e può essere tinteggiato.
- Apertura per installazione Ø 132 mm.
- Foro per installazione suggerito: 140 x 140 mm

- Invisible recessed fitting for false ceilings
- Once the false ceiling has been plastered the recessed fitting will become an integral part of the ceiling and can be painted.
- Opening required for installation: Ø 132 mm.
- Recommended installation hole: 140 x 140 mm

- Unsichtbarer Einsatz für abgehängte Decken
- Nachdem man die abgehängte Decke gipsverputzt hat, wird der Einsatz zu einem integrierenden Bestandteil der Decke und kann angestrichen werden.
- Installationsöffnung Ø 132 mm.
- Empfohlene Einbauöffnung: 140 x 140 mm

- Empotrado invisible para falsos techos
- Después de haber nivelado el falso techo con yeso, el empotrado resulta formar parte integrante del propio techo y se puede pintar.
- Apertura para la instalación Ø 132 mm.
- Orificio para instalación aconsejado: 140 x 140 mm

- Скрытый встраиваемый прибор для установки в подвесные потолки
- Оштукатурив потолок гипсовой штукатуркой, встроенный прибор станет неотъемлемой частью самого потолка и можно его покрасить.
- Отверстие для установки Ø 132 мм.
- Рекомендуемое монтажное отверстие: 140 x 140 мм

Omologazioni

CE ▽ □ [T12 ⬠]

Type-approvals

CE ▽ □ [T12 ⬠]

Zulassungen

CE ▽ □ [T12 ⬠]

Homologaciones

CE ▽ □ [T12 ⬠]

Омологации

CE ▽ □ [T12 ⬠]

T10



- GU10
- 1x40W

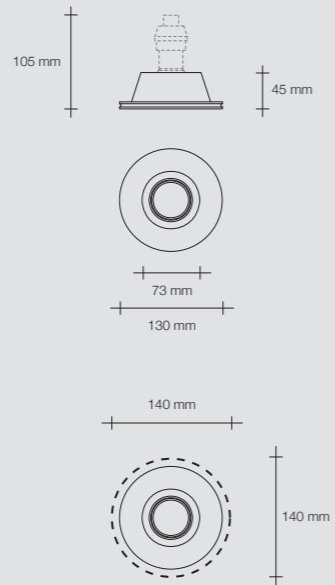

Ingombro comprensivo di lampada con altezza indicativa di 50 mm e portalampana fornito

Overall lamp (approx. 50 mm high) and lamp holder (supplied) size

Gesamtabmessungen einschließlich Lampe mit einer ungefähren Höhe von 50 mm und mitgelieferter Lampenfassung

Medidas con lámpara con altura indicativa de 50 mm y portálamparas incluido

Габариты включают лампу высотой примерно 50 мм и входящий в комплект поставки цоколь

140 x 140 mm

Foro per installazione suggerito

Recommended installation hole

Empfohlene Einbauöffnung

Orificio para instalación aconsejado

Рекомендуемое монтажное отверстие

Esempio di prodotto verniciato
Example of painted product
Beispiel für das gestrichene Produkt
Ejemplo de producto pintado
Пример покрашенного прибора





- Incasso invisibile per controsoffitti
- Dopo aver rasato a gesso il controsoffitto, l'incasso risulta parte integrante del soffitto stesso e può essere tinteggiato.
- Apertura per installazione Ø 102 mm.
- Foro per installazione suggerito: 110 x 110 mm

- Invisible recessed fitting for false ceilings
- Once the false ceiling has been plastered the recessed fitting will become an integral part of the ceiling and can be painted.
- Opening required for installation: Ø 102 mm.
- Recommended installation hole: 110 x 110 mm

- Unsichtbarer Einsatz für abgehängte Decken
- Nachdem man die abgehängte Decke gipsverputzt hat, wird der Einsatz zu einem integrierenden Bestandteil der Decke und kann angestrichen werden.
- Installationsöffnung Ø 102 mm.
- Empfohlene Einbauöffnung: 110 x 110 mm

- Empotrado invisible para falsos techos
- Después de haber nivelado el falso techo con yeso, el empotrado resulta formar parte integrante del propio techo y se puede pintar.
- Apertura para la instalación Ø 102 mm.
- Orificio para instalación aconsejado: 110 x 110 mm

- Скрытый встраиваемый прибор для установки в подвесные потолки
- Оштукатурив потолок гипсовой штукатуркой, встроенный прибор станет неотъемлемой частью самого потолка и можно его покрасить.
- Отверстие для установки Ø 102 мм.
- Рекомендуемое монтажное отверстие: 110 x 110 мм

Omologazioni
CE ▽ □ [T24 ⬠]

Type-approvals
CE ▽ □ [T24 ⬠]

Zulassungen
CE ▽ □ [T24 ⬠]

Homologaciones
CE ▽ □ [T24 ⬠]

Омологации
CE ▽ □ [T24 ⬠]

T22



- GU10
- 1x40W

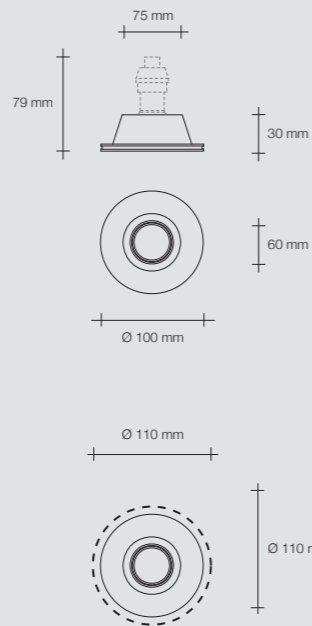

Ingombro comprensivo di lampada con altezza indicativa di 50 mm e portalampada fornito

Overall lamp (approx. 50 mm high) and lamp holder (supplied) size

Gesamtabmessungen einschließlich Lampe mit einer ungefähren Höhe von 50 mm und mitgelieferter Lampenfassung

Medidas con lámpara con altura indicativa de 50 mm y portalámparas incluido

Габариты включают лампу высотой примерно 50 мм и входящий в комплект поставки цоколь

110 x 110 mm

Foro per installazione suggerito

Recommended installation hole

Empfohlene Einbauöffnung

Orificio para instalación aconsejado

Рекомендуемое монтажное отверстие



ATTICA

Esempio di prodotto installato e verniciato
Example of fitted and painted product
Beispiel für das installierte und gestrichene Produkt
Ejemplo de producto instalado y pintado
Пример установленного и покрашенного прибора



ATTICA



- Incasso invisibile per controsoffitti
- Dopo aver rasato a gesso il controsoffitto, l'incasso risulta parte integrante del soffitto stesso e può essere tinteggiato.
- Apertura per installazione 122x122 mm.
- Foro per installazione suggerito: 130 x 130 mm

- Invisible recessed fitting for false ceilings
- Once the false ceiling has been plastered the recessed fitting will become an integral part of the ceiling and can be painted.
- Opening required for installation: 122x122 mm.
- Recommended installation hole: 130 x 130 mm

- Unsichtbarer Einsatz für abgehängte Decken
- Nachdem man die abgehängte Decke gipsverputzt hat, wird der Einsatz zu einem integrierenden Bestandteil der Decke und kann angestrichen werden.
- Installationsöffnung 122x122 mm.
- Empfohlene Einbauöffnung: 130 x 130 mm

- Empotrado invisible para falsos techos
- Después de haber nivelado el falso techo con yeso, el empotrado resulta formar parte integrante del propio techo y se puede pintar.
- Apertura para la instalación 122x122 mm.
- Orificio para instalación aconsejado: 130 x 130 mm

- Скрытый встраиваемый прибор для установки в подвесные потолки
- Оштукатурив потолок гипсовой штукатуркой, встроенный прибор станет неотъемлемой частью самого потолка и можно его покрасить.
- Отверстие для установки 122x122 мм.
- Рекомендуемое монтажное отверстие: 130 x 130 мм

Omologazioni
CE ▽ □ [T06 ⬢]

Type-approvals
CE ▽ □ [T06 ⬢]

Zulassungen
CE ▽ □ [T06 ⬢]

Homologaciones
CE ▽ □ [T06 ⬢]

Омологации
CE ▽ □ [T06 ⬢]

T04



- GU10
- 1x40W

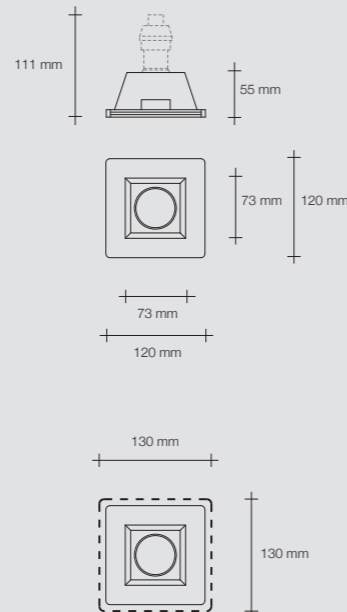

Ingombro comprensivo di lampada con altezza indicativa di 50 mm e portalamпада fornito

Overall lamp (approx. 50 mm high) and lamp holder (supplied) size

Gesamtabmessungen einschließlich Lampe mit einer ungefähren Höhe von 50 mm und mitgelieferter Lampenfassung

Medidas con lámpara con altura indicativa de 50 mm y portálámparas incluido

Габариты включают лампы высотой примерно 50 мм и входящий в комплект поставки цоколь

130 x 130 mm

Foro per installazione suggerito
Recommended installation hole
Empfohlene Einbauöffnung
Orificio para instalación aconsejado
Рекомендуемое монтажное отверстие

Esempio di prodotto verniciato
Example of painted product
Beispiel für das gestrichene Produkt
Ejemplo de producto pintado
Пример покрашенного прибора

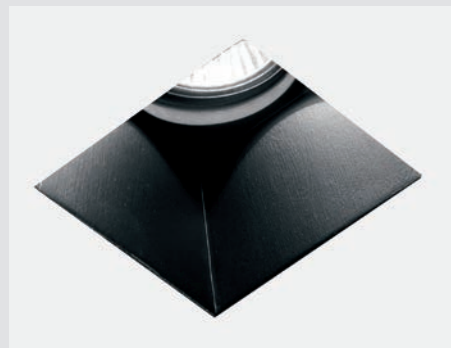

ATTICA GLASS



- Incasso invisibile per controsoffitti
- Dopo aver rasato a gesso il controsoffitto, l'incasso risulta parte integrante del soffitto stesso e può essere tinteggiato.
- Apertura per installazione 122x122 mm.
- Foro per installazione suggerito: 130 x 130 mm

- Invisible recessed fitting for false ceilings
- Once the false ceiling has been plastered the recessed fitting will become an integral part of the ceiling and can be painted.
- Opening required for installation: 122x122 mm.
- Recommended installation hole: 130 x 130 mm

- Unsichtbarer Einsatz für abgehängte Decken
- Nachdem man die abgehängte Decke gipsverputzt hat, wird der Einsatz zu einem integrierenden Bestandteil der Decke und kann angestrichen werden.
- Installationsöffnung 122x122 mm.
- Empfohlene Einbauöffnung: 130 x 130 mm

- Empotrado invisible para falsos techos
- Después de haber nivelado el falso techo con yeso, el empotrado resulta formar parte integrante del propio techo y se puede pintar.
- Apertura para la instalación 122x122 mm.
- Orificio para instalación aconsejado: 130 x 130 mm

- Скрытый встраиваемый прибор для установки в подвесные потолки
- Оштукатурив потолок гипсовой штукатуркой, встроенный прибор станет неотъемлемой частью самого потолка и можно его покрасить.
- Отверстие для установки 122x122 мм.
- Рекомендуемое монтажное отверстие: 130 x 130 мм

Omologazioni
CE [T30]

Type-approvals
CE [T30]

Zulassungen
CE [T30]

Homologaciones
CE [T30]

Омологации
CE [T30]

T28



- GU10
- 1x40W

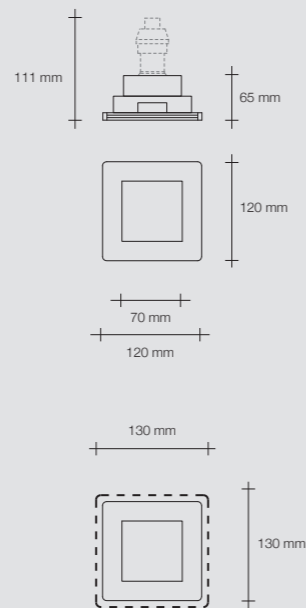

Ingombro comprensivo di lampada con altezza indicativa di 50 mm e portalampada fornito

Overall lamp (approx. 50 mm high) and lamp holder (supplied) size

Gesamtabmessungen einschließlich Lampe mit einer ungefähren Höhe von 50 mm und mitgelieferter Lampenfassung

Medidas con lámpara con altura indicativa de 50 mm y portalámparas incluido

Габариты включают лампу высотой примерно 50 мм и входящий в комплект поставки цоколь

130 x 130 mm

Foro per installazione suggerito
Recommended installation hole
Empfohlene Einbauöffnung
Orificio para instalación aconsejado
Рекомендуемое монтажное отверстие



ATTICA ORIENTABILE



- Luce orientabile
- Incasso invisibile per controsoffitti
- Dopo aver rasato a gesso il controsoffitto, l'incasso risulta parte integrante del soffitto stesso e può essere tinteggiato.
- Apertura per installazione 122x122 mm.
- Foro per installazione suggerito: 130 x 130 mm

- Adjustable light
- Invisible recessed fitting for false ceilings
- Once the false ceiling has been plastered the recessed fitting will become an integral part of the ceiling and can be painted.
- Opening required for installation: 122x122 mm.
- Recommended installation hole: 130 x 130 mm

- orientierbares Licht
- Unsichtbarer Einsatz für abgehängte Decken
- Nachdem man die abgehängte Decke gipsverputzt hat, wird der Einsatz zu einem integrierenden Bestandteil der Decke und kann angestrichen werden.
- Installationsöffnung 122x122 mm.
- Empfohlene Einbauöffnung: 130 x 130 mm

- Luz orientable
- Empotrado invisible para falsos techos
- Después de haber nivelado el falso techo con yeso, el empotrado resulta formar parte integrante del propio techo y se puede pintar.
- Apertura para la instalación 122x122 mm.
- Orificio para instalación aconsejado: 130 x 130 mm

- Свет с изменением направления
- Скрытый встраиваемый прибор для установки в подвесные потолки
- Оштукатурив потолок гипсовой штукатуркой, встроенный прибор станет неотъемлемой частью самого потолка и можно его покрасить.
- Отверстие для установки 122x122 мм.
- Рекомендуемое монтажное отверстие: 130 x 130 мм

Omologazioni

CE ▽ □ [T178 ⬢]

Type-approvals

CE ▽ □ [T178 ⬢]

Zulassungen

CE ▽ □ [T178 ⬢]

Homologaciones

CE ▽ □ [T178 ⬢]

Омологации

CE ▽ □ [T178 ⬢]

T177



- GU10
- 1x40W

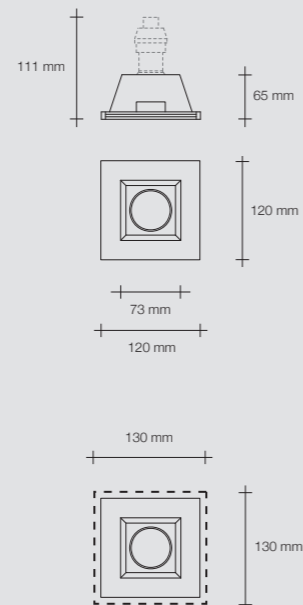

Ingombro comprensivo di lampada con altezza indicativa di 50 mm e portalampada fornito

Overall lamp (approx. 50 mm high) and lamp holder (supplied) size

Gesamtabmessungen einschließlich Lampe mit einer ungefähren Höhe von 50 mm und mitgelieferter Lampenfassung

Medidas con lámpara con altura indicativa de 50 mm y portalámparas incluido

Габариты включают лампу высотой примерно 50 мм и входящий в комплект поставки цоколь

130 x 130 mm

Foro per installazione suggerito
Recommended installation hole
Empfohlene Einbauöffnung
Orificio para instalación aconsejado
Рекомендуемое монтажное отверстие





- Incasso invisibile per controsoffitti e muro tramite cassaforma
- Dopo aver rasato a gesso il controsoffitto, l'incasso risulta parte integrante del soffitto stesso e può essere tinteggiato.
- Foro per installazione suggerito: 130 x 130 mm

- Invisible recessed fitting for false ceilings or walls, using a housing box.
- Once the false ceiling has been plastered the recessed fitting will become an integral part of the ceiling and can be painted.
- Recommended installation hole: 130 x 130 mm

- Unsichtbar werdender Einsatz für abgehängte Decken und mit Verschalung für Mauern
- Nachdem man die abgehängte Decke gipsverputzt hat, wird der Einsatz zu einem integrierenden Bestandteil der Decke und kann angestrichen werden.
- Empfohlene Einbauöffnung: 130 x 130 mm

- Empotrada invisible para falsos techos y pared utilizando encofrado
- Después de haber nivelado el falso techo con yeso, el empotrado resulta formar parte integrante del propio techo y se puede pintar.
- Orificio para instalación aconsejado: 130 x 130 mm

- Скрытый встраиваемый прибор для установки в подвесные потолки с помощью опалубки.
- Оштукатурив потолок гипсовой штукатуркой, встроенный прибор станет неотъемлемой частью самого потолка и можно его покрасить.
- Рекомендуемое монтажное отверстие: 130 x 130 mm

Omologazioni

CE (T03 LED)

Type-approvals

CE (T03 LED)

Zulassungen

CE (T03 LED)

Homologaciones

CE (T03 LED)

Омологации

CE (T03 LED)

T01



- GU10
- 1x40W

T01 C

Cassaforma
Formwork
Verschalung
Encofrado
Опалубка

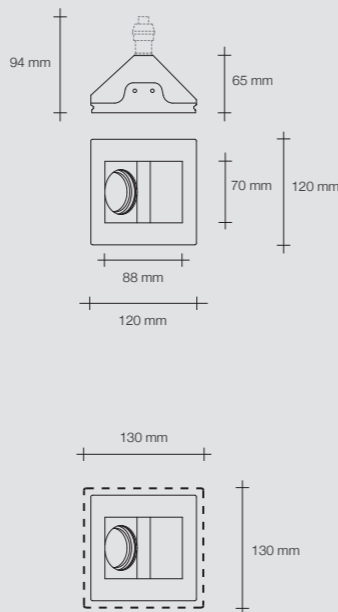
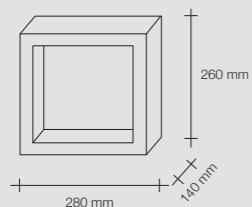

Ingombro comprensivo di lampada con altezza indicativa di 50 mm e portalampada fornito

Overall lamp (approx. 50 mm high) and lamp holder (supplied) size

Gesamtmaße einschließlich Lampe mit einer ungefähren Höhe von 50 mm und mitgelieferter Lampenfassung

Medidas con lámpara con altura indicativa de 50 mm y portalámparas incluido

Габариты включают лампу высотой примерно 50 мм и входящий в комплект поставки цоколь

130 x 130 mm

Foro per installazione suggerito
Recommended installation hole
Empfohlene Einbauöffnung
Orificio para instalación aconsejado
Рекомендуемое монтажное отверстие



Supporto regolabile. Adjustable bracket.
Регулируемый Winkel. Escudera regulable.
Регулируемый крепежный уголок





- Incasso invisibile per controsoffitti e tramite cassaforma per laterizio
 - Dopo aver rasato a gesso il controsoffitto, l'incasso risulta parte integrante del soffitto stesso e può essere tinteggiato.
 - T51 con emergenza ha 3 ore di autonomia al 23% di flusso luminoso.
 - Foro per installazione suggerito: 275 x 275 mm

- Invisible recessed fitting for false ceilings and, using a housing box, for brickwork.
 - Once the false ceiling has been plastered the recessed fitting will become an integral part of the ceiling and can be painted.
 - T51 with emergency device has 3 hours of autonomy at 23% of light flux.
 - Recommended installation hole: 275 x 275 mm

- Unsichtbar werdender Einsatz für abgehängte Decken und mit Verschalung für Mauerwerk
 - Nachdem man die abgehängte Decke gipsverputzt hat, wird der Einsatz zu einem integrierenden Bestandteil der Decke und kann angestrichen werden.
 - T51 mit Notfunktion hat 3 Stunden Autonomie bei 23% des Lichtflusses.
 - Empfohlene Einbauöffnung: 275 x 275 mm

- Empotrada invisible para falsos techos y con encofrado para pared.
 - Después de haber enlucido el falso techo con yeso, el empotrado resulta parte integrante del propio techo y se puede pintar.
 - T51 con emergencia, tiene 3 horas de autonomía con un 23% de flujo luminoso.
 - Orificio para instalación aconsejado: 275 x 275 mm

- Скрытый встраиваемый прибор для установки в подвесные потолки и с помощью опалубки в кирпичную кладку.
 - Оштукатурив потолок гипсовой штукатуркой, встроенный прибор станет неотъемлемой частью самого потолка и его можно покрасить.
 - T51 в аварийной ситуации имеет 3 часа резерва и 23% светового потока.
 - Рекомендуемое монтажное отверстие: 275 x 275 mm

Omologazioni
 CE V

Type-approvals
 CE V

Zulassungen
 CE V

Homologaciones
 CE V

Омологации
 CE V

T32 2xE27



Optional:
 - T32 Lampadina
 Lampadine fluorescente 25W

Optional:
 - T32 light bulb
 25W fluorescent bulbs

Optional:
 - T32 Lampe
 Leuchtstofflampe 25W

Opcional:
 - T32 Bombilla
 Bombilla fluorescente 25W

По специальному заказу:
 - T32 лампочка
 Флуоресцентная лампочка 25 Вт

T31 C

Cassaforma
 Formwork
 Verschalung
 Encofrado
 Опалубка

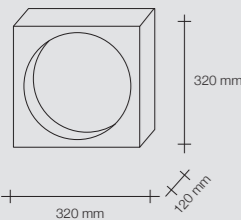

T51 G24 q3 - 2x26W



con emergenza
 Optional:
 - T51 Lampadina
 Lampadine fluorescente 26W

with emergency device
 Optional:
 - T51 light bulb
 26W fluorescent bulbs

mit Notfunktion
 Optional:
 - T51 Lampe
 Leuchtstofflampe 26W

con emergencia
 Opcional:
 - T51 Bombilla
 Bombilla fluorescente 26W

С аварийным освещением
 По специальному заказу:
 - T51 лампочка
 Флуоресцентная лампочка 26 Вт

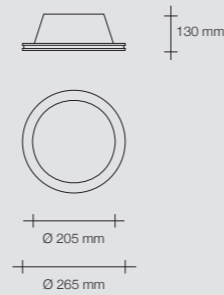

275 x 275 mm
 Foro per installazione suggerito
 Recommended installation hole
 Empfohlene Einbauöffnung
 Orificio para instalación aconsejado
 Рекомендуемое монтажное отверстие

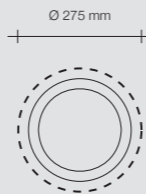



INCASSI IN GESSO A PARETE RECESSED PLASTER WALL LIGHTS

Serie di apparecchi da incasso in gesso a scomparsa totale per pareti in cartongesso e con controcassa per laterizi. Nati per soddisfare le esigenze di applicazioni moderne, suggestive e discrete.

Range of plaster products for fully recessed installation for walls in plasterboard and with recessed fixing kit for brick-built structures. Created to meet the needs of modern, elegant and discreet applications.

Geräteserie zum Einlassen aus Gips, vollständig verschwindend, für Gipskartonwände und mit Außengehäuse für Mauerwerk. Wurden für moderne, suggestive und diskrete Anwendungsmöglichkeiten entworfen.

Serie de aparatos para empotrar en yeso completamente escamoteables para paredes de cartón yeso y con contracaja para ladrillos. Creados para satisfacer las exigencias de aplicaciones modernas, sugestivas y discretas.

Серия встраиваемых и полностью скрываемых приборов из гипса для подвесных потолков или перегородок из гипсокартона, а также с специальным корпусом для установки в кирпичные стены или потолки. Эта серия была разработана для удовлетворения требований, связанных с ее современными, привлекательными и ненавязчивыми применениями.



- Lampada in gesso da incasso invisibile per muri tramite cassaforma e cartongessi senza cassaforma.
- Dopo aver rasato a gesso il muro, l'incasso risulta parte integrante del muro stesso e può essere tinteggiato.
- Adatto per lampade alogene, fluorescenza e led.
- Con attacco E14.
- Foro per installazione suggerito: 260 x 360 mm

- Invisible, recessed plaster lamp fitted using a housing box for walls and without a housing box for plasterboard.
- Once the wall has been plastered the recessed fitting will become an integral part of the wall and can be painted.
- Suitable for halogen or fluorescent bulbs and LEDs.
- With E14 connection.
- Recommended installation hole: 260 x 360 mm

- Unsichtbar werdende Lampe zum Einlassen aus Gips, für Mauerwerk mit Verschalung und für Gipskarton ohne Verschalung.
- Nachdem man die Wand gipsverputzt hat, wird der Einsatz zu einem integrierenden Bestandteil der Wand und kann angestrichen werden.
- Geeignet für Halogenlampen, Leuchtstofflampen und Led.
- Mit Anschluss E14.
- Empfohlene Einbauöffnung: 260 x 360 mm

- Lámpara de yeso para empotrar, invisible, para paredes mediante encofrado y para cartón yeso sin encofrado
- Después de haber enlucido el tabique, el empotrado forma parte integrante de la propia pared y se puede pintar.
- Apto para lámparas halógenas, fluorescentes y de LED.
- Con casquillo E14.
- Orificio para instalación aconsejado: 260 x 360 mm

- Гипсовая лампа встраиваемая, невидимая для стен с помощью опалубки и гипсокартона - без опалубки.
- После шпаклевки стены, корпус светильника становится составной частью самой стены и его можно покрасить.
- Подходит для галогенных, флуоресцентных, светодиодных лампочек.
- С цоколем E14.
- Рекомендуемое монтажное отверстие: 260 x 360 mm

Omologazioni

CE V ⊕

Type-approvals

CE V ⊕

Zulassungen

CE V ⊕

Homologaciones

CE V ⊕

Омологации

CE V ⊕

T76



- 60W
- E14

T76 C

Cassaforma
Formwork
Verschalung
Encofrado
Опалубка

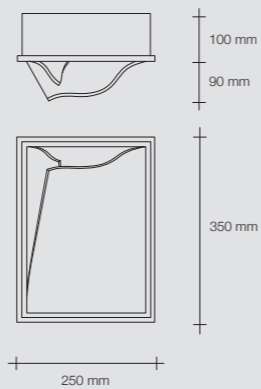
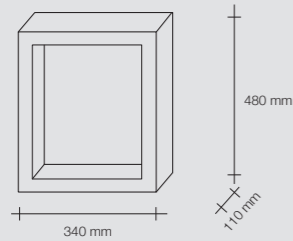

260 x 360 mm
Foro per installazione suggerito
Recommended installation hole
Empfohlene Einbauöffnung
Orificio para instalación aconsejado
Рекомендуемое монтажное

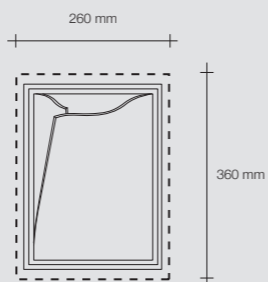



GESSE DA PARETE E SOFFITTO
PLASTER WALL AND CEILING LIGHTS

Serie di apparecchi da parete e soffitto in gesso nati per soddisfare le esigenze di applicazioni moderne, suggestive e discrete.

Range of wall and ceiling mounted products in plaster, designed to meet the needs of modern, evocative and discreet applications.

Geräteserie aus Gips für Wand und Decke für moderne, suggestive und diskrete Anwendungen.

Serie de aparatos para pared y techo de yeso, creados para satisfacer las exigencias de aplicaciones modernas, sugestivas y discretas.

Серия настенных и потолочных приборов из гипса для удовлетворения требований, связанных с их современными, привлекательными и ненавязчивыми применениями.







- Lampada da parete
in gesso a una luce
- Per lampadine GX53
- Lampadine installabili:
fluorescenti o led

- Plaster wall
one-light lamp
- Designed for GX53 bulbs
- Bulbs: fluorescent
or LED

- Wandleuchte aus Gips mit
einem Leuchtmittel
- Für GX53 Leuchtmittel
- Installierbare Leuchtmittel:
Leuchtstoff oder LED

- Luminaria para pared
de yeso con una luz
- Para lámparas GX53
- Lámparas que se pueden
instalar: fluorescentes o de LED

- Настенный гипсовый светильник
с одной лампочкой
- Лампы с цоколем GX53
- Применяемые лампочки:
флуоресцентные или светодиодные

Modello depositato

Registered design

Eingetragenes Modell

Modelo depositado

Зарегистрированная модель

Omologazioni

CE V A

Type-approvals

CE V A

Zulassungen

CE V A

Homologaciones

CE V A

Омологации

CE V A

T394



- GX53
- 1x10W

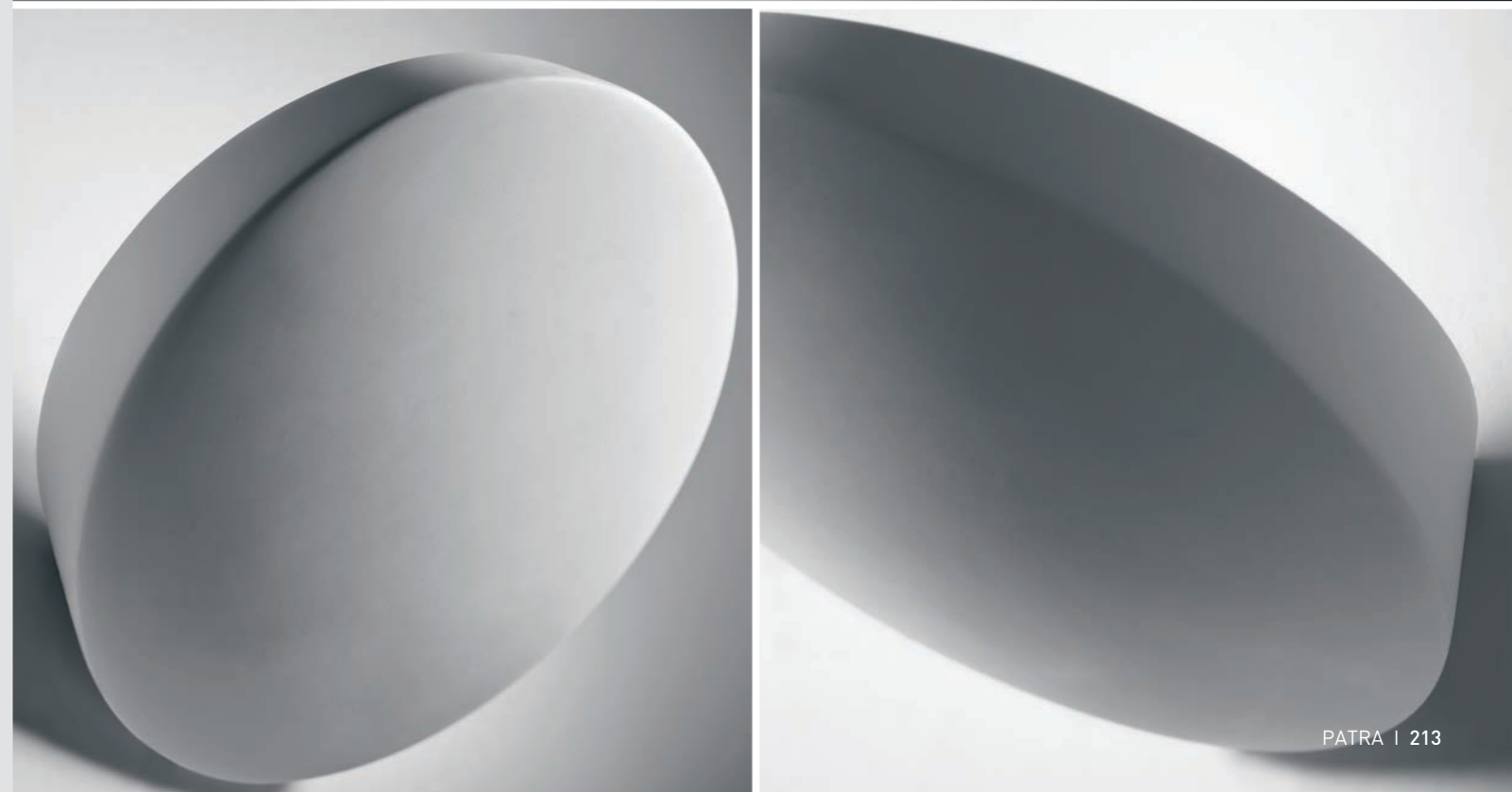
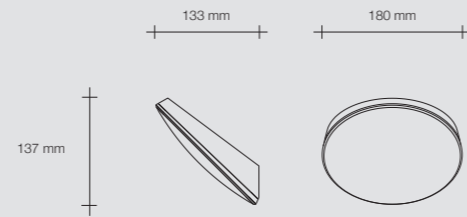





- Lampada da parete
in gesso a due luci
- Per lampadine GX53
- Lampadine installabili:
fluorescenti o led

- Plaster wall
two-lights lamp
- For GX53 bulbs
- Bulbs: fluorescent or LED

- Wandleuchte aus Gips
mit zwei Leuchtmitteln
- Für GX53 Leuchtmittel
- Installierbare Leuchtmittel:
Leuchtstoff oder LED

- Luminaria para pared
de yeso con dos luces
- Para lámparas GX53
- Lámparas que se pueden
instalar: fluorescentes o de LED

- Настенный гипсовый
светильник с двумя лампочками
- Лампы с цоколем GX53
- Применяемые лампочки:
флуоресцентные или светодиодные

Modello depositato

Registered design

Eingetragenes Modell

Modelo depositado

Зарегистрированная модель

Omologazioni

CE V A

Type-approvals

CE V A

Zulassungen

CE V A

Homologaciones

CE V A

Омологации

CE V A

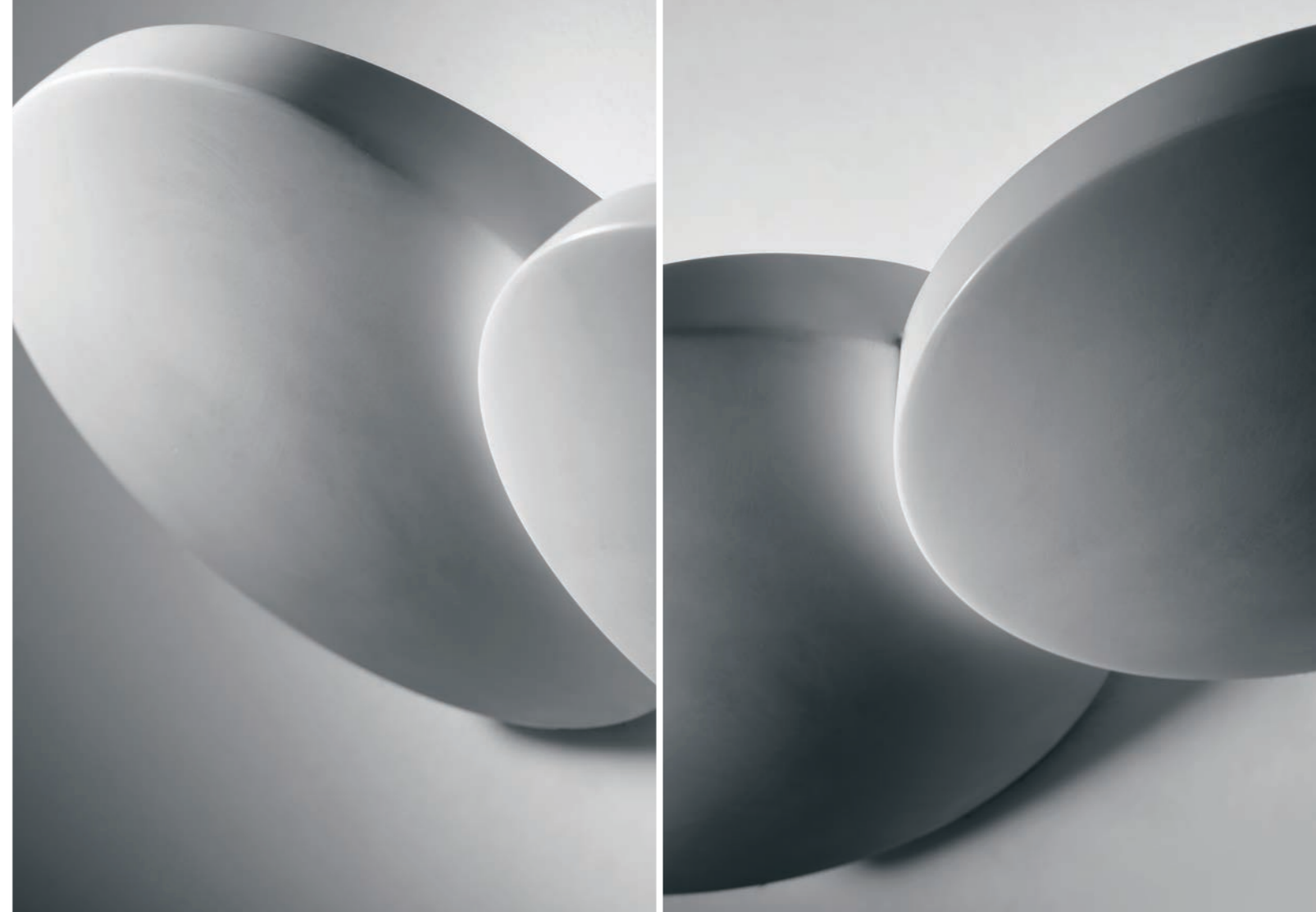

T395



- GX53
- 2x10W

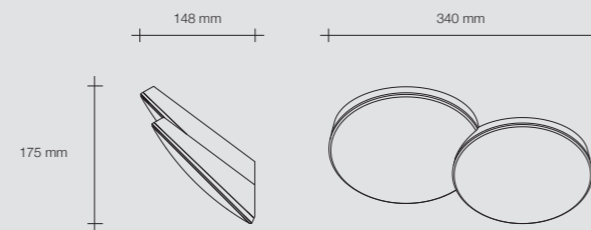









- Lampada a soffitto in gesso ad una luce con diffusore in vetro opalino
- Per lampadine GX53
- Lampadine installabili: fluorescenti o led

- One-light gypsum ceiling lamp with opal glass diffuser
- Designed for GX53 bulbs
- Bulbs: fluorescent or LED

- Deckenleuchte für Gipskarton für eine Lichtquelle mit opalem Glasschirm
- Für GX53 Leuchtmittel
- Installierbare Leuchtmittel: Leuchtstoff oder LED

- Lámpara de techo de escayola con una luz con difusor de cristal opalino
- Para lámparas GX53
- Lámparas que se pueden instalar: fluorescentes o de LED

- Потолочный точечный светильник из гипса с одним источником света и диффузором из матового стекла
- Лампы с цоколем GX53
- Применяемые лампочки: флуоресцентные или светодиодные

Modello depositato

Registered design

Eingetragenes Modell

Modelo depositado

Зарегистрированная модель

Omologazioni

CE V

Type-approvals

CE V

Zulassungen

CE V

Homologaciones

CE V

Омолгации

CE V

T387



- GX53
- 1x10W

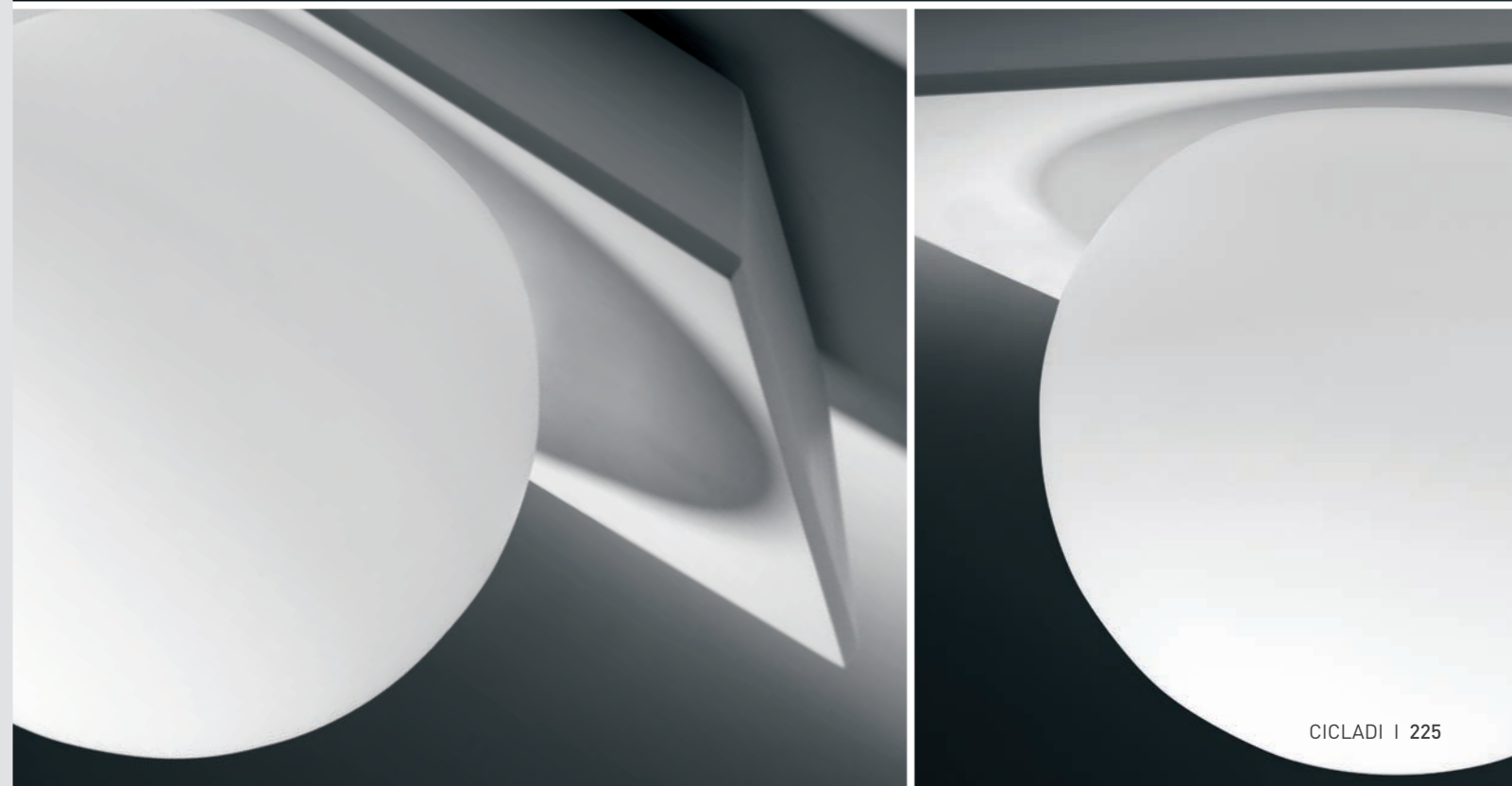
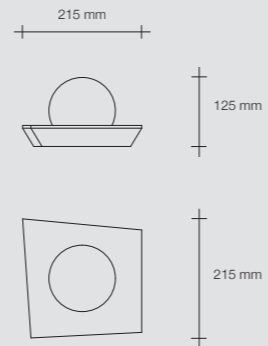





- Lampada a soffitto in gesso a due luci con diffusori in vetro opalino
- Per lampadine GX53
- Lampadine installabili: fluorescenti o led

- Two-light gypsum ceiling lamp with opal glass diffuser
- Designed for GX53 bulbs
- Bulbs: fluorescent or LED

- Deckenleuchte für Gipskarton für zwei Lichtquellen mit opalem Glasschirm
- Für GX53 Leuchtmittel
- Installierbare Leuchtmittel: Leuchtstoff oder LED

- Lámpara de techo de escayola con dos luces con difusores de cristal opalino
- Para lámparas GX53
- Lámparas que se pueden instalar: fluorescentes o de LED

- Потолочный точечный светильник из гипса с двумя источниками света и диффузорами из матового стекла
- Лампы с цоколем GX53
- Применяемые лампочки: флуоресцентные или светодиодные

Modello depositato

Registered design

Eingetragenes Modell

Modelo depositado

Зарегистрированная модель

Omologazioni



Type-approvals



Zulassungen



Homologaciones



Омологации



T388



- GX53
- 2x10W

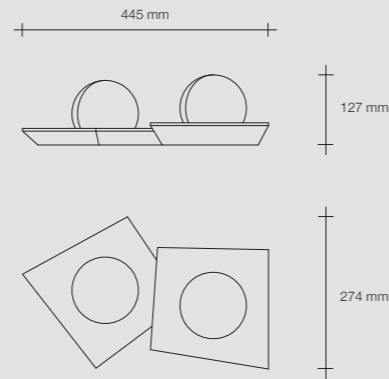





- Lampada a soffitto in gesso a tre luci con diffusori in vetro opalino
- Per lampadine GX53
- Lampadine installabili: fluorescenti o led

- Three-light gypsum ceiling lamp with opal glass diffuser
- Designed for GX53 bulbs
- Bulbs: fluorescent or LED

- Deckenleuchte für Gipskarton für drei Lichtquellen mit opalem Glasschirm
- Für GX53 Leuchtmittel
- Installierbare Leuchtmittel: Leuchtstoff oder LED

- Lámpara de techo de escayola con tres luces con difusores de cristal opalino
- Para lámparas GX53
- Lámparas que se pueden instalar: fluorescentes o de LED

- Потолочный точечный светильник из гипса с тремя источниками света и диффузорами из матового стекла
- Лампы с цоколем GX53
- Применяемые лампочки: флуоресцентные или светодиодные

Modello depositato

Registered design

Eingetragenes Modell

Modelo depositado

Зарегистрированная модель

Omologazioni

Type-approvals

Zulassungen

Homologaciones

Омологации

CE V

CE V

CE V

CE V

CE V

T389



- GX53
- 3x10W

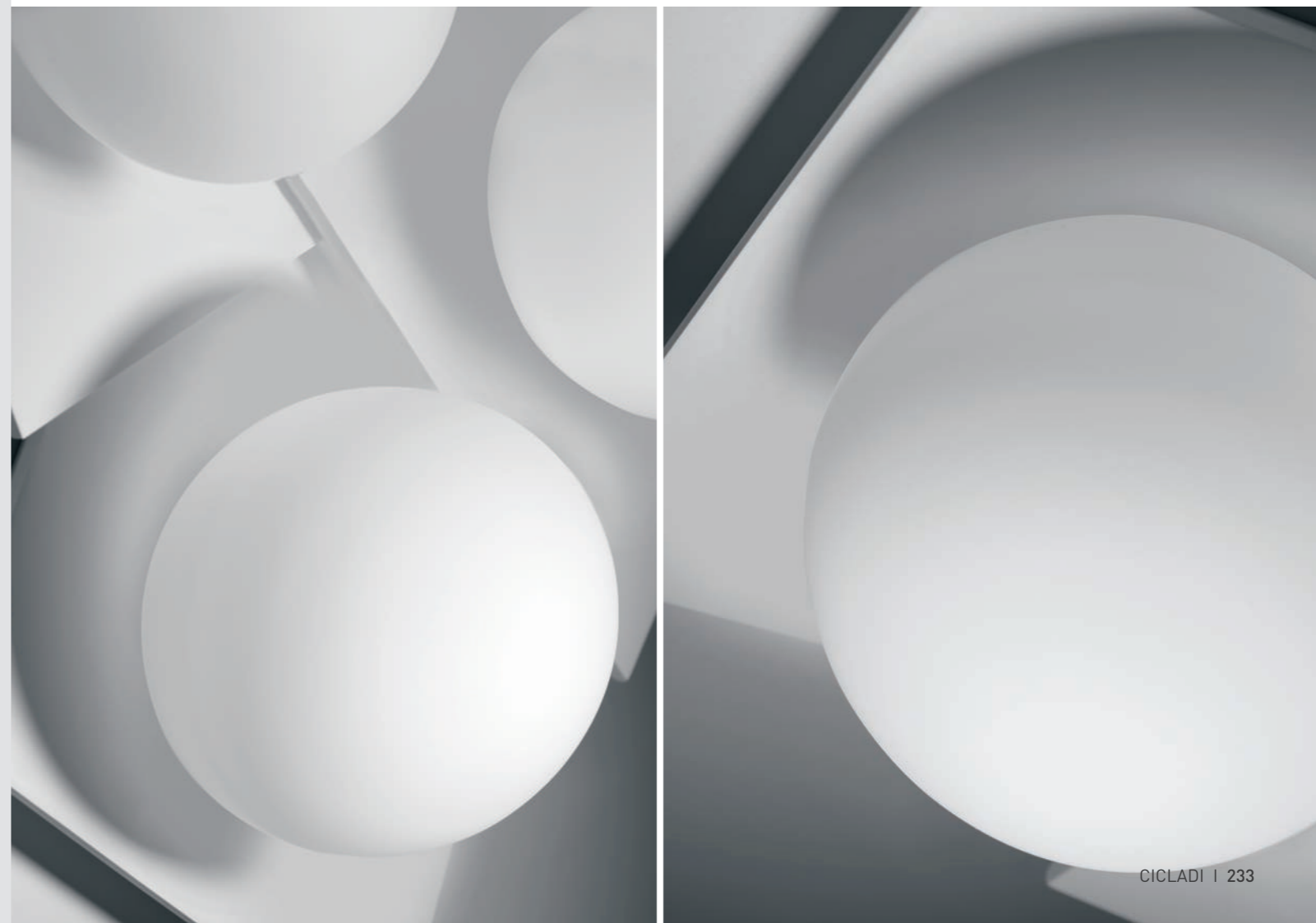
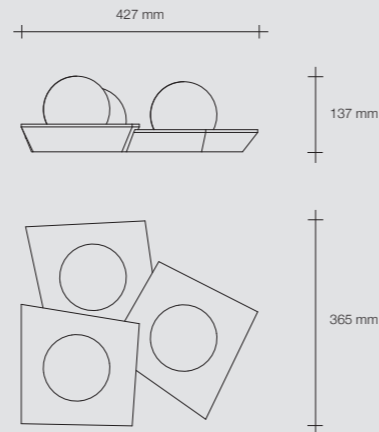









- Lampada da parete in gesso a una luce con diffusore in vetro opalino
- Per lampadine GX53
- Lampadine installabili: fluorescenti o led

Modello depositato

Omologazioni

CE V ⊕

- One-light gypsum wall lamp with opal glass diffuser
- Designed for GX53 bulbs
- Bulbs: fluorescent or LED

Registered design

Type-approvals

CE V ⊕

- Wandleuchte für Gipskarton für eine Lichtquelle mit opalem Glasschirm
- Für GX53 Leuchtmittel
- Installierbare Leuchtmittel: Leuchtstoff oder LED

Eingetragenes Modell

Zulassungen

CE V ⊕



- Lámpara de pared de escayola con una luz con difusor de cristal opalino
- Para lámparas GX53
- Lámparas que se pueden instalar: fluorescentes o de LED

Modelo depositado

Homologaciones

CE V ⊕

- Настенный точечный светильник из гипса с одним источником света и диффузором из матового стекла
- Лампы с цоколем GX53
- Применяемые лампочки: флуоресцентные или светодиодные

Зарегистрированная модель

Омологации

CE V ⊕



T385



- GX53
- 1x10W

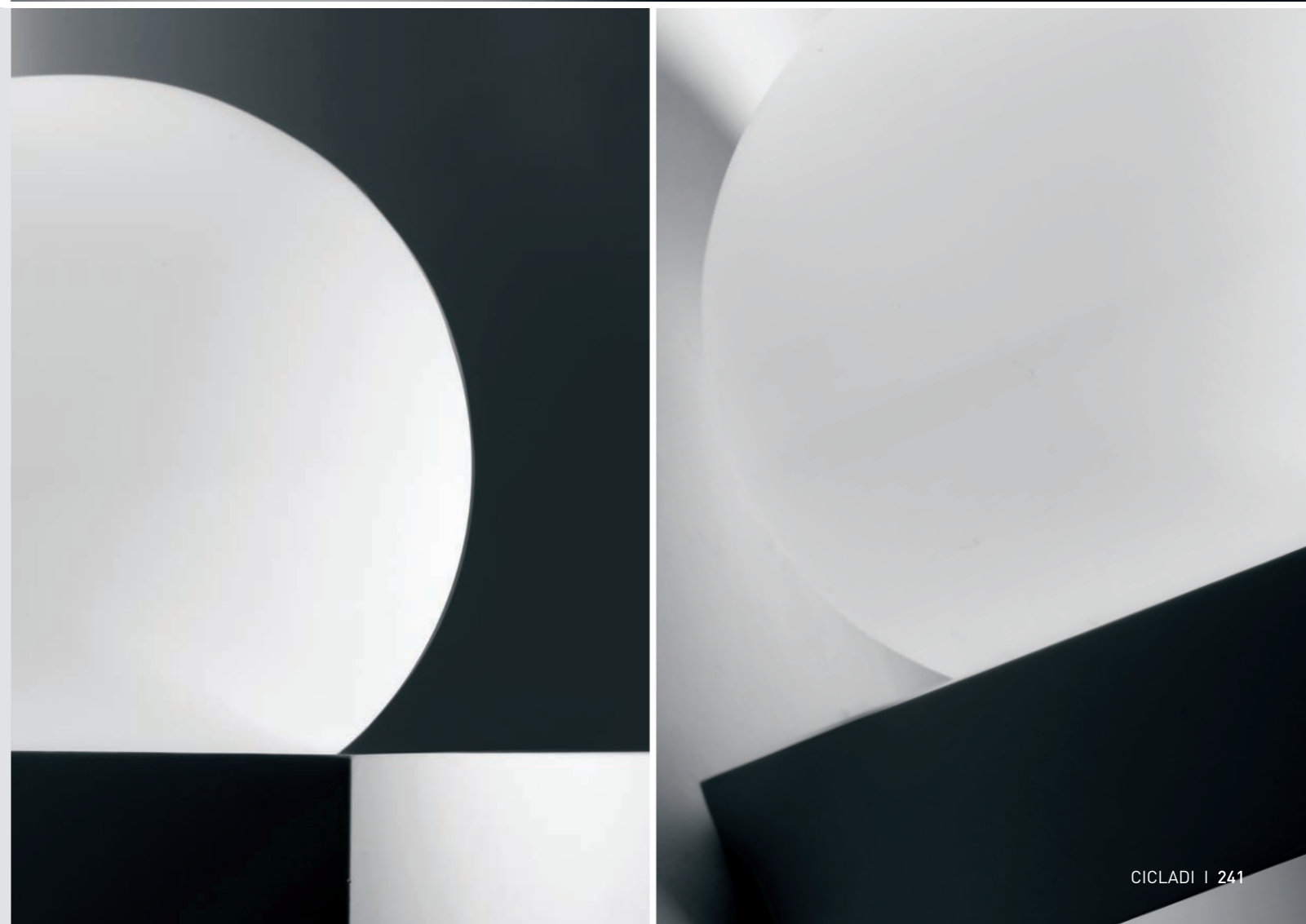
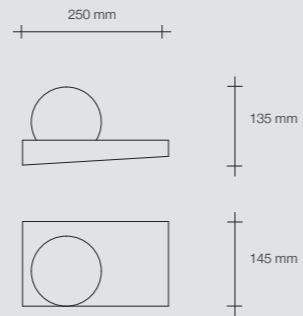



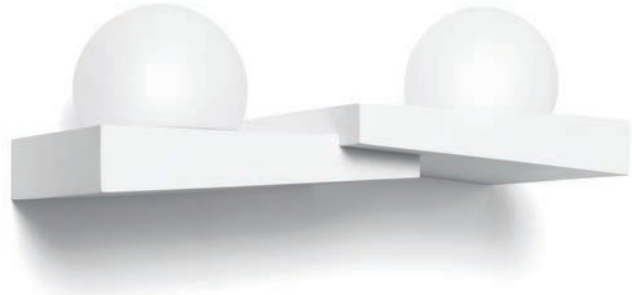

- Lampada da parete in gesso a due luci biemissiva con diffusori in vetro opalino
- Per lampadine GX53
- Lampadine installabili: fluorescenti o led

- Two-light bi-emission gypsum wall lamp with opal glass diffuser
- For GX53 bulbs
- Bulbs: fluorescent or LED

- Wandleuchte für Gipskarton für zwei Doppellichtquellen mit opalem Glasschirm
- Für GX53 Leuchtmittel
- Installierbare Leuchtmittel: Leuchtstoff oder LED

- Lámpara de pared de escayola con dos luces con doble emisión con difusores de cristal opalino
- Para lámparas GX53
- Lámparas que se pueden instalar: fluorescentes o de LED

- Настенный точечный светильник из гипса с двумя источниками света с двойным излучением и диффузорами из матового стекла
- Лампы с цоколем GX53
- Применяемые лампочки: флуоресцентные или светодиодные

Modello depositato

Registered design

Eingetragenes Modell

Modelo depositado

Зарегистрированная модель

Omologazioni

CE V ⊕

Type-approvals

CE V ⊕

Zulassungen

CE V ⊕

Homologaciones

CE V ⊕

Омолгации

CE V ⊕



T386



- GX53
- 2x10W

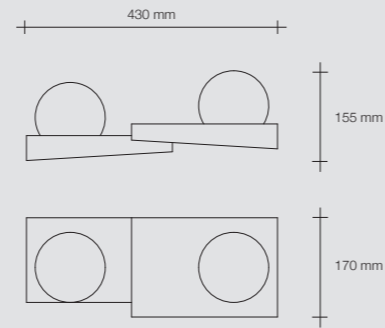



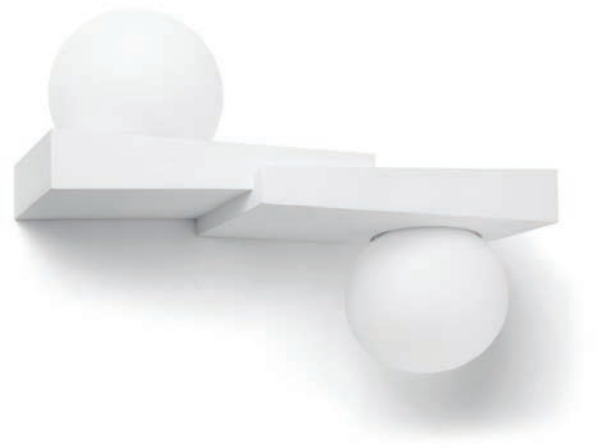

- Lampada da parete in gesso a due luci biemissiva con diffusori in vetro opalino
- Per lampadine GX53
- Lampadine installabili: fluorescenti o led

Modello depositato

Omologazioni

CE  

- Two-light bi-emission gypsum wall lamp with opal glass diffuser
- For GX53 bulbs
- Bulbs: fluorescent or LED

Registered design

Type-approvals

CE  

- Wandleuchte für Gipskarton für zwei Doppellichtquellen mit opalem Glasschirm
- Für GX53 Leuchtmittel
- Installierbare Leuchtmittel: Leuchtstoff oder LED

Eingetragenes Modell

Zulassungen

CE  



- Lámpara de pared de escayola con dos luces con doble emisión con difusores de cristal opalino
- Para lámparas GX53
- Lámparas que se pueden instalar: fluorescentes o de LED

Modelo depositado

Homologaciones

CE  

- Настенный точечный светильник из гипса с двумя источниками света с двойным излучением и диффузорами из матового стекла
- Лампы с цоколем GX53
- Применяемые лампочки: флуоресцентные или светодиодные

Зарегистрированная модель

Омологации

CE  

T396



- GX53
- 2x10W

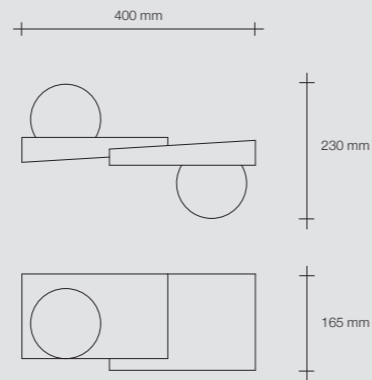



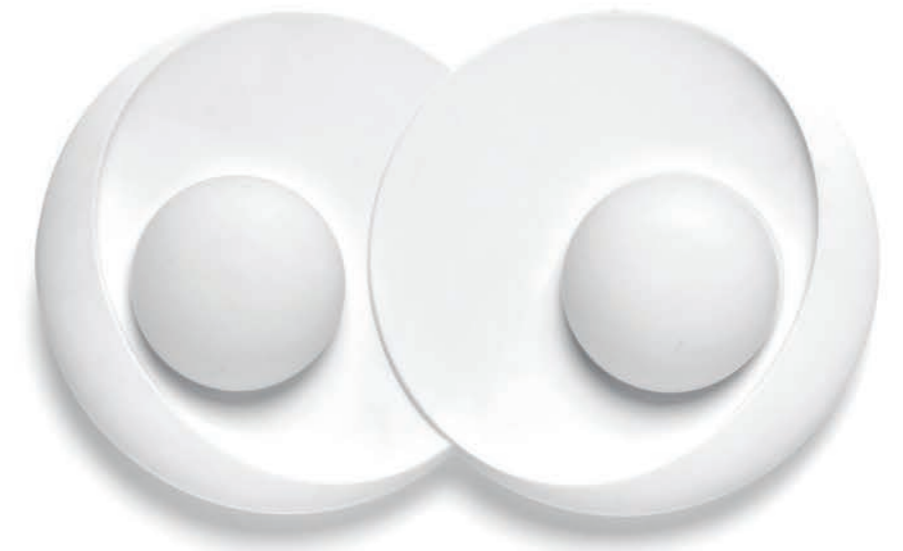





- Lampada a soffitto
in gesso a due luci
- Per lampadine GX53
- Lampadine installabili:
fluorescenti o led

- 2-light plaster
ceiling light
- Designed for GX53 bulbs
- Bulbs: fluorescent or LED

- Deckenleuchte aus Gips
mit zwei Lampen
- Für GX53 Leuchtmittel
- Installierbare Leuchtmittel:
Leuchtstoff oder LED

- Lámpara de techo de yeso
con dos luces
- Para lámparas GX53
- Lámparas que se pueden
instalar: fluorescentes o
de LED

- Потолочный гипсовый светильник
с двумя лампочками
- Лампы с цоколем GX53
- Применяемые лампочки:
флуоресцентные или светодиодные

Modello depositato

Registered design

Eingetragenes Modell

Modelo depositado

Зарегистрированная модель

Omologazioni

CE V A

Type-approvals

CE V A

Zulassungen

CE V A

Homologaciones

CE V A

Омологации

CE V A

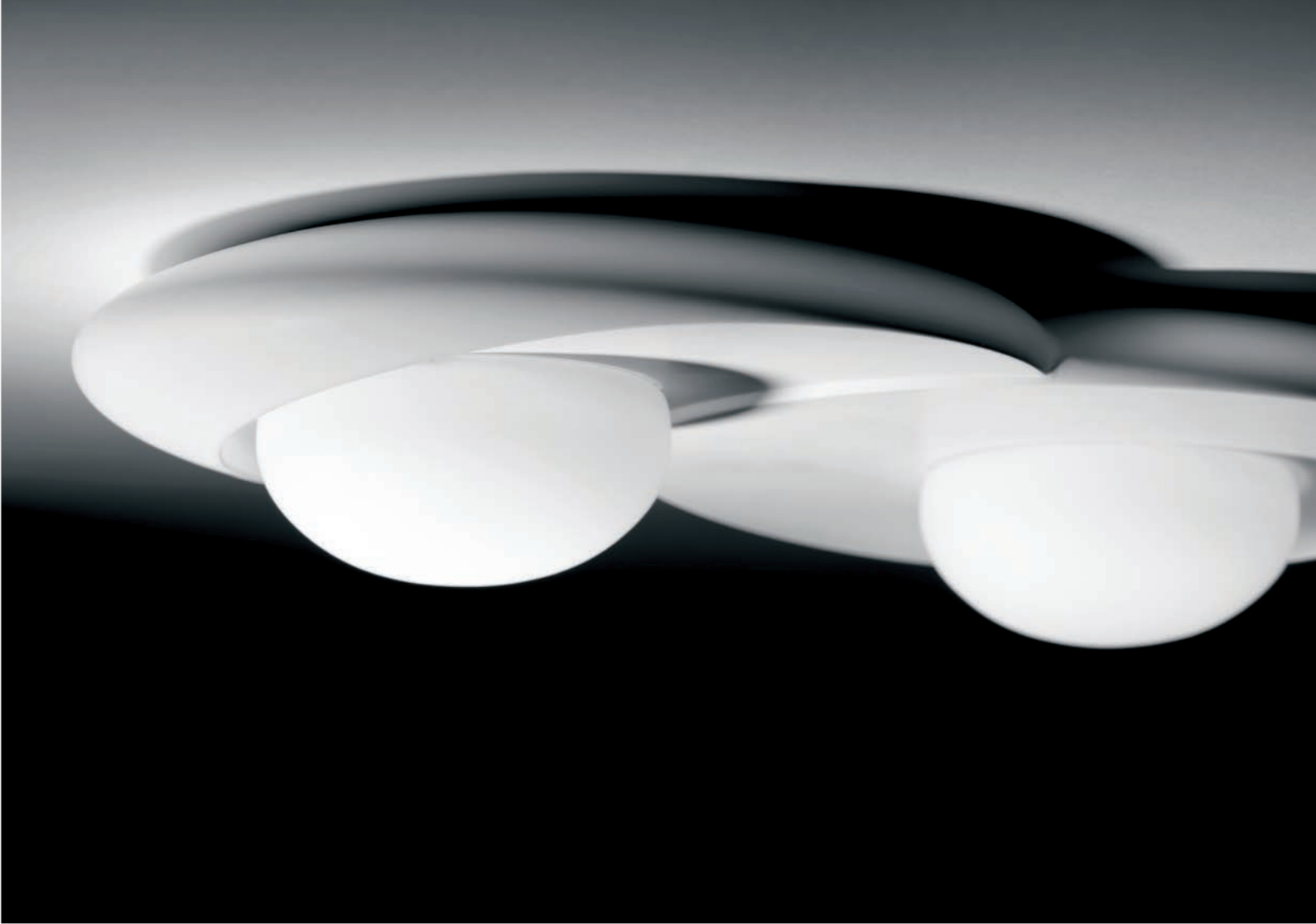

T401



- GX53
- 2x10W

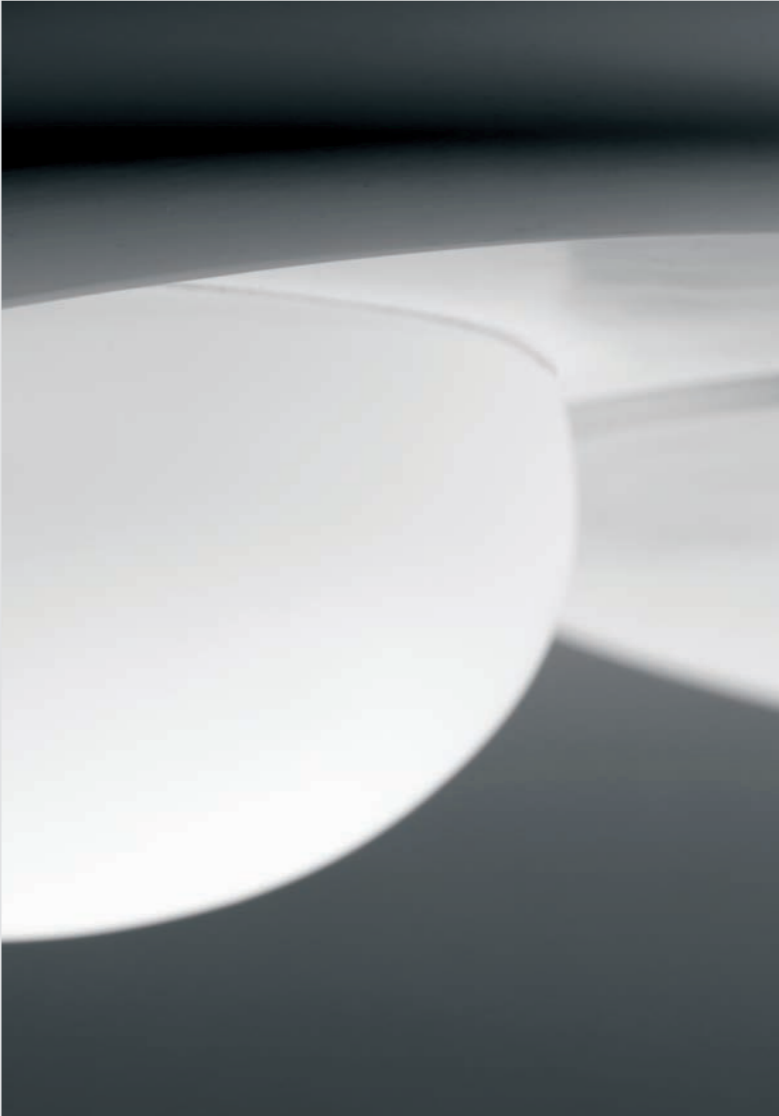
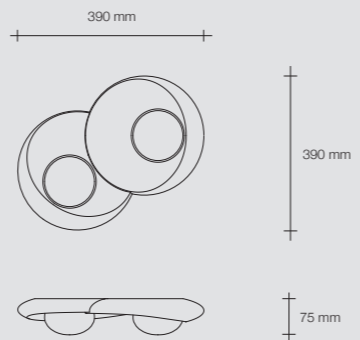





- Lampada a soffitto in gesso a tre luci
- Per lampadine GX53
- Lampadine installabili: fluorescenti o led

- 3-light plaster ceiling light
- Designed for GX53 bulbs
- Bulbs: fluorescent or LED

- Deckenleuchte aus Gips mit drei Lampen
- Für GX53 Leuchtmittel
- Installierbare Leuchtmittel: Leuchtstoff oder LED

- Lámpara de techo de yeso con tres luces
- Para lámparas GX53
- Lámparas que se pueden instalar: fluorescentes o de LED

- Потолочный гипсовый светильник с тремя лампочками
- Лампы с цоколем GX53
- Применяемые лампочки: флуоресцентные или светодиодные

Modello depositato

Registered design

Eingetragenes Modell

Modelo depositado

Зарегистрированная модель

Omologazioni



Type-approvals



Zulassungen



Homologaciones



Омологации



T402



- GX53
- 3x10W

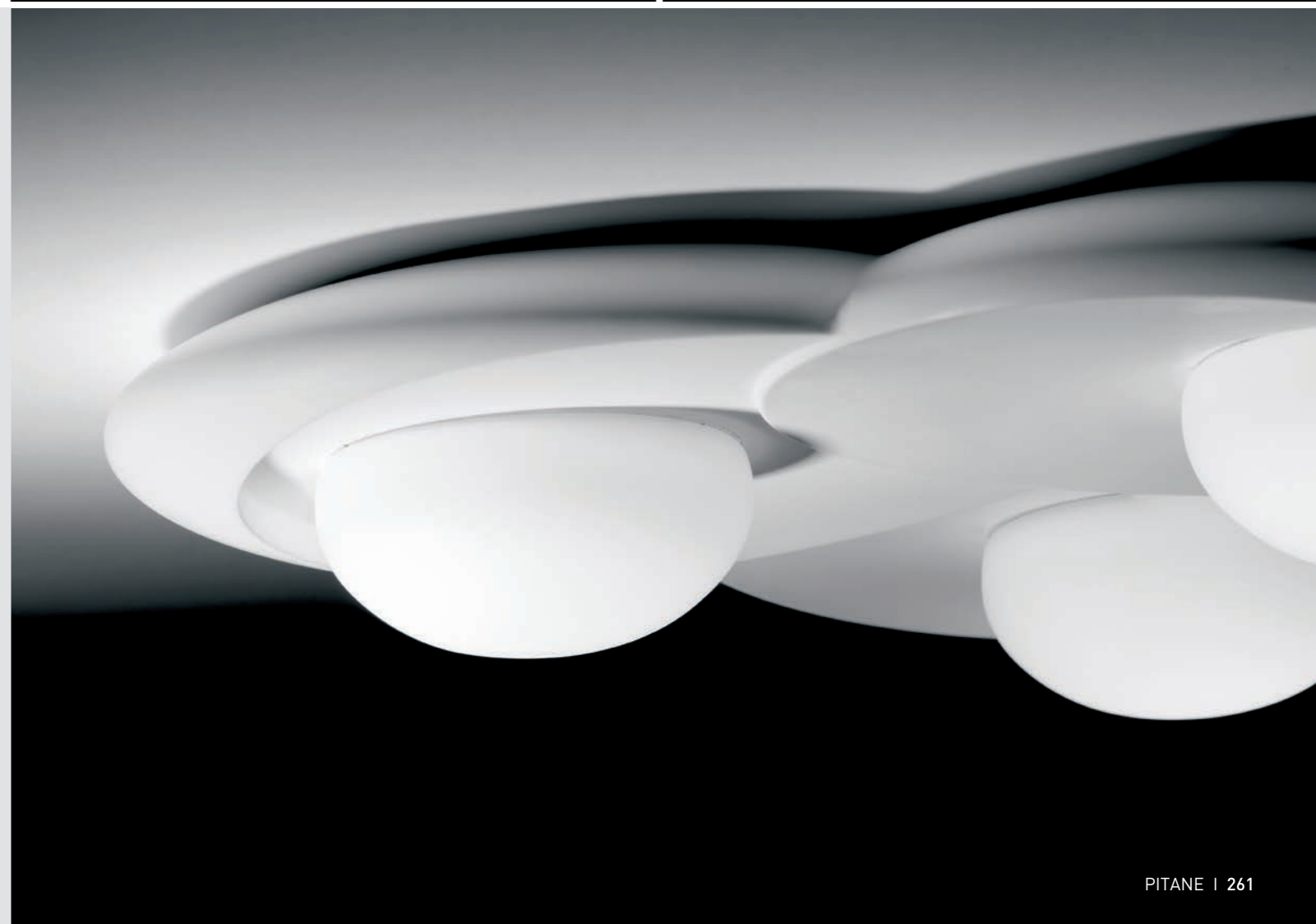
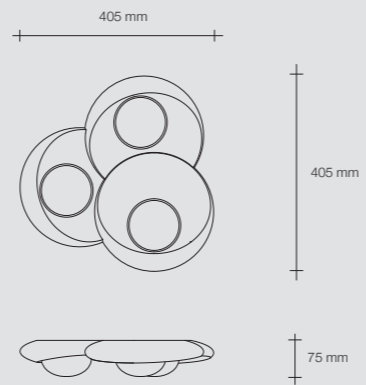









- Lampada a parete
in gesso a una luce
- Per lampadine GX53
- Lampadine installabili:
fluorescenti o led

- Plaster wall
one-light lamp
- Designed for GX53 bulbs
- Bulbs: fluorescent or LED

- Wandleuchte aus Gips
mit einem Leuchtmittel
- Für GX53 Leuchtmittel
- Installierbare Leuchtmittel:
Leuchtstoff oder LED

- Luminaria para pared
de yeso con una luz
- Para lámparas GX53
- Lámparas que se pueden
instalar: fluorescentes o
de LED

- Настенный гипсовый светильник
с одной лампочкой
- Лампы с цоколем GX53
- Применяемые лампочки:
флуоресцентные или светодиодные

Modello depositato

Registered design

Eingetragenes Modell

Modelo depositado

Зарегистрированная модель

Omologazioni

CE V A

Type-approvals

CE V A

Zulassungen

CE V A

Homologaciones

CE V A

Омологации

CE V A



T399



- GX53
- 1x10W

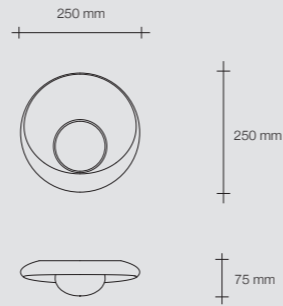





- Lampada da parete
in gesso a due luci
- Per lampadine GX53
- Lampadine installabili:
fluorescenti o led

- Plaster wall two-lights lamp
- For GX53 bulbs
- Bulbs: fluorescent or LED

- Wandleuchte aus Gips mit zwei
Leuchtmitteln
- Für GX53 Leuchtmittel
- Installierbare Leuchtmittel:
Leuchtstoff oder LED

- Luminaria para pared de yeso
con dos luces
- Para lámparas GX53
- Lámparas que se pueden
instalar: fluorescentes o
de LED

- Настенный гипсовый
светильник с двумя лампочками
- Лампы с цоколем GX53
- Применяемые лампочки:
флуоресцентные или светодиодные

Modello depositato

Registered design

Eingetragenes Modell

Modelo depositado

Зарегистрированная модель

Omologazioni

CE V A

Type-approvals

CE V A

Zulassungen

CE V A

Homologaciones

CE V A

Омологации

CE V A



T400



- GX53
- 2x10W

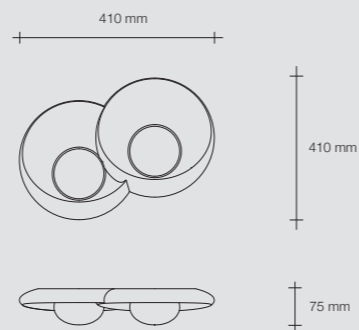









- Lampada a soffitto in gesso ad una luce
- Per lampadine GX53
- Lampadine installabili: fluorescenti o led

- Single-light plaster ceiling light
- Designed for GX53 bulbs
- Bulbs: fluorescent or LED

- Deckenleuchte aus Gips mit einer Lampe
- Für GX53 Leuchtmittel
- Installierbare Leuchtmittel: Leuchtstoff oder LED

- Lámpara de techo de yeso con una luz
- Para lámparas GX53
- Lámparas que se pueden instalar: fluorescentes o de LED

- Потолочный гипсовый светильник с одной лампочкой
- Лампы с цоколем GX53
- Применяемые лампочки: флуоресцентные или светодиодные

Modello depositato

Registered design

Eingetragenes Modell

Modelo depositado

Зарегистрированная модель

Omologazioni

CE

Type-approvals

CE

Zulassungen

CE

Homologaciones

CE

Омологации

CE

T339



- GX53
- 1x10W

Ø 160 mm

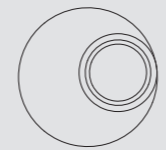

60 mm

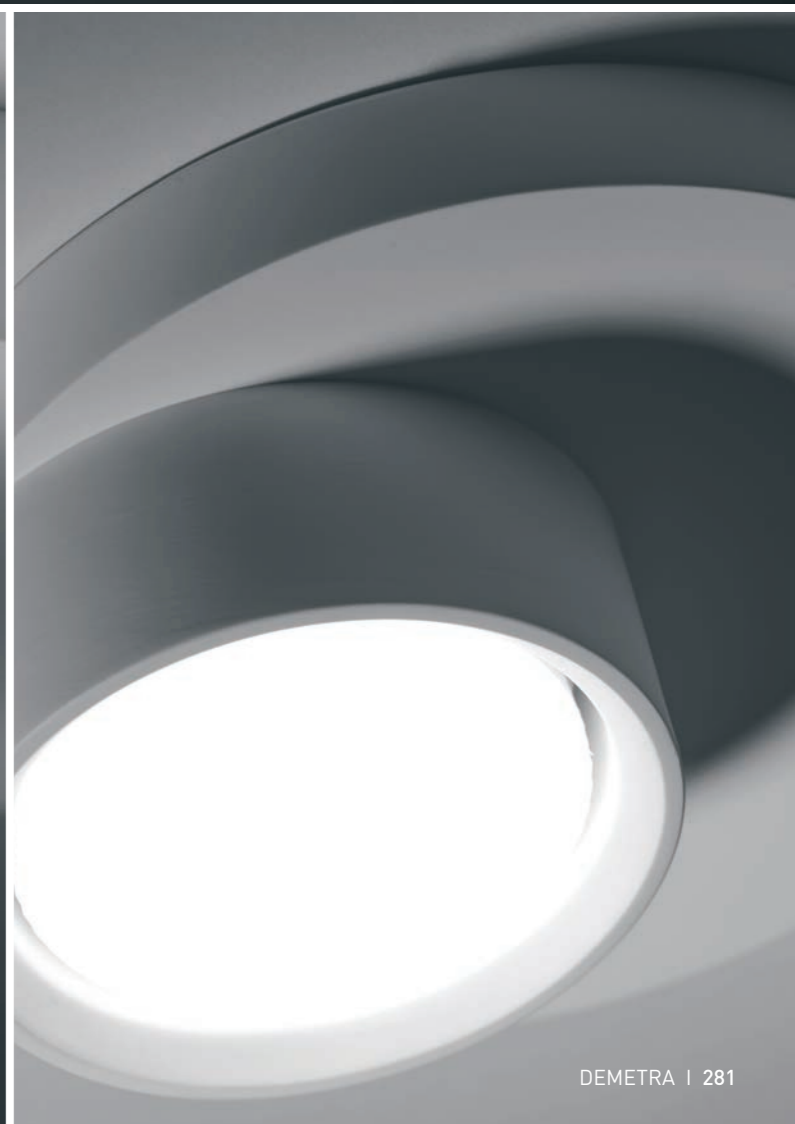





- Lampada a soffitto in gesso a due luci
- Per lampadine GX53
- Lampadine installabili: fluorescenti o led

- 2-light plaster ceiling light
- Designed for GX53 bulbs
- Bulbs: fluorescent or LED

- Deckenleuchte aus Gips mit zwei Lampen
- Für GX53 Leuchtmittel
- Installierbare Leuchtmittel: Leuchtstoff oder LED

- Lámpara de techo de yeso con dos luces
- Para lámparas GX53
- Lámparas que se pueden instalar: fluorescentes o de LED

- Потолочный гипсовый светильник с двумя лампочками
- Лампы с цоколем GX53
- Применяемые лампочки: флуоресцентные или светодиодные

Modello depositato

Registered design

Eingetragenes Modell

Modelo depositado

Зарегистрированная модель

Omologazioni



Type-approvals



Zulassungen



Homologaciones



Омологации



T358



- GX53
- 2x10W

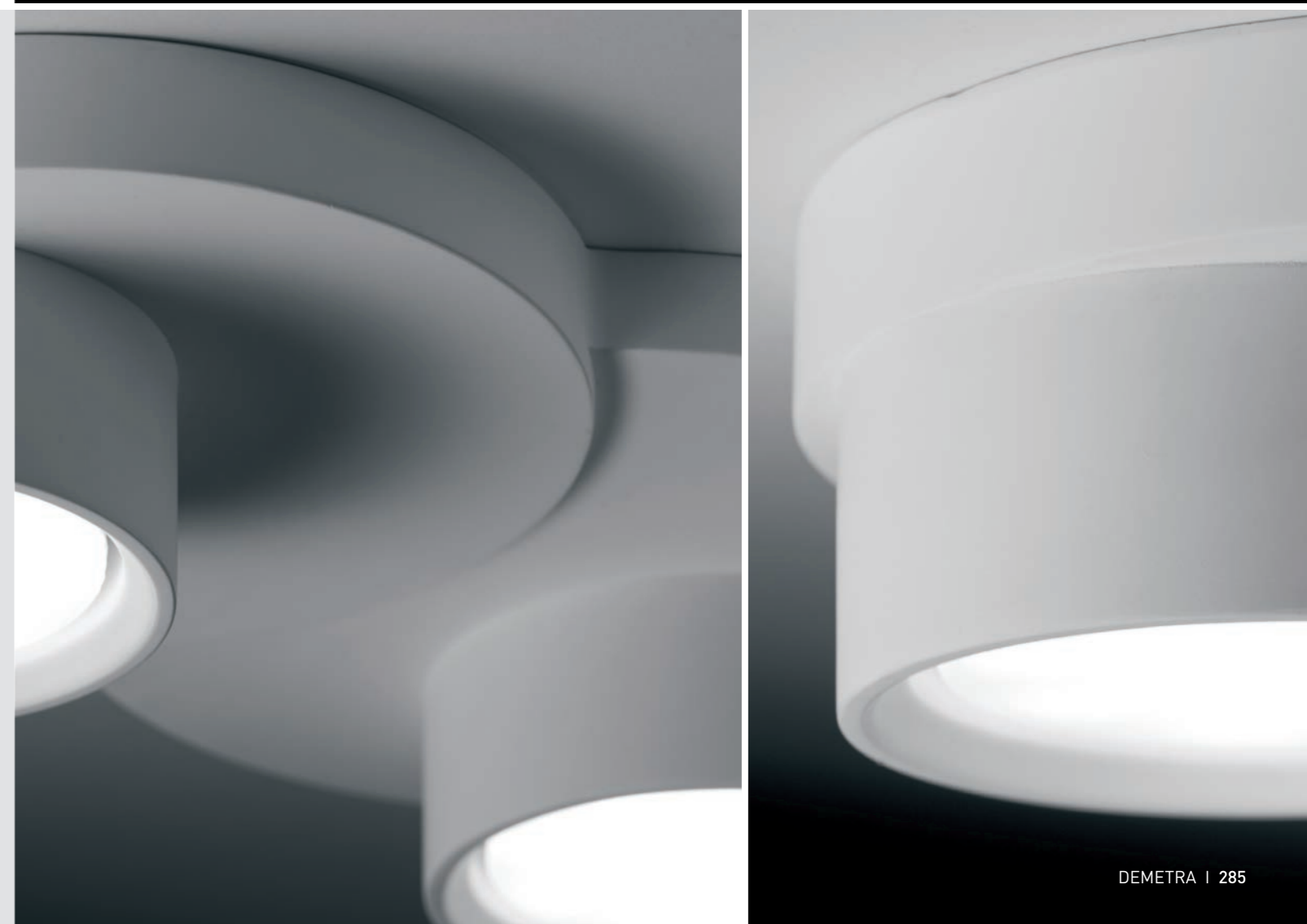
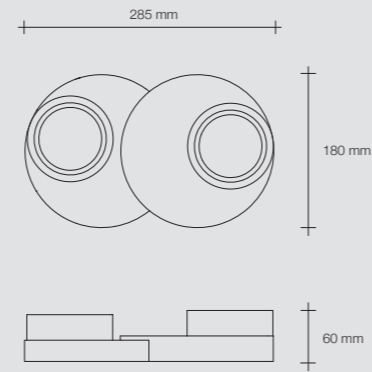





- Lampada a soffitto in gesso a tre luci
- Per lampadine GX53
- Lampadine installabili: fluorescenti o led

- 3-light plaster ceiling light
- Designed for GX53 bulbs
- Bulbs: fluorescent or LED

- Deckenleuchte aus Gips mit drei Lampen
- Für GX53 Leuchtmittel
- Installierbare Leuchtmittel: Leuchtstoff oder LED

- Lámpara de techo de yeso con tres luces
- Para lámparas GX53
- Lámparas que se pueden instalar: fluorescentes o de LED

- Потолочный гипсовый светильник с тремя лампочками
- Лампы с цоколем GX53
- Применяемые лампочки: флуоресцентные или светодиодные

Modello depositato

Registered design

Eingetragenes Modell

Modelo depositado

Зарегистрированная модель

Omologazioni



Type-approvals



Zulassungen



Homologaciones



Омологации



T359



- GX53
- 3x10W

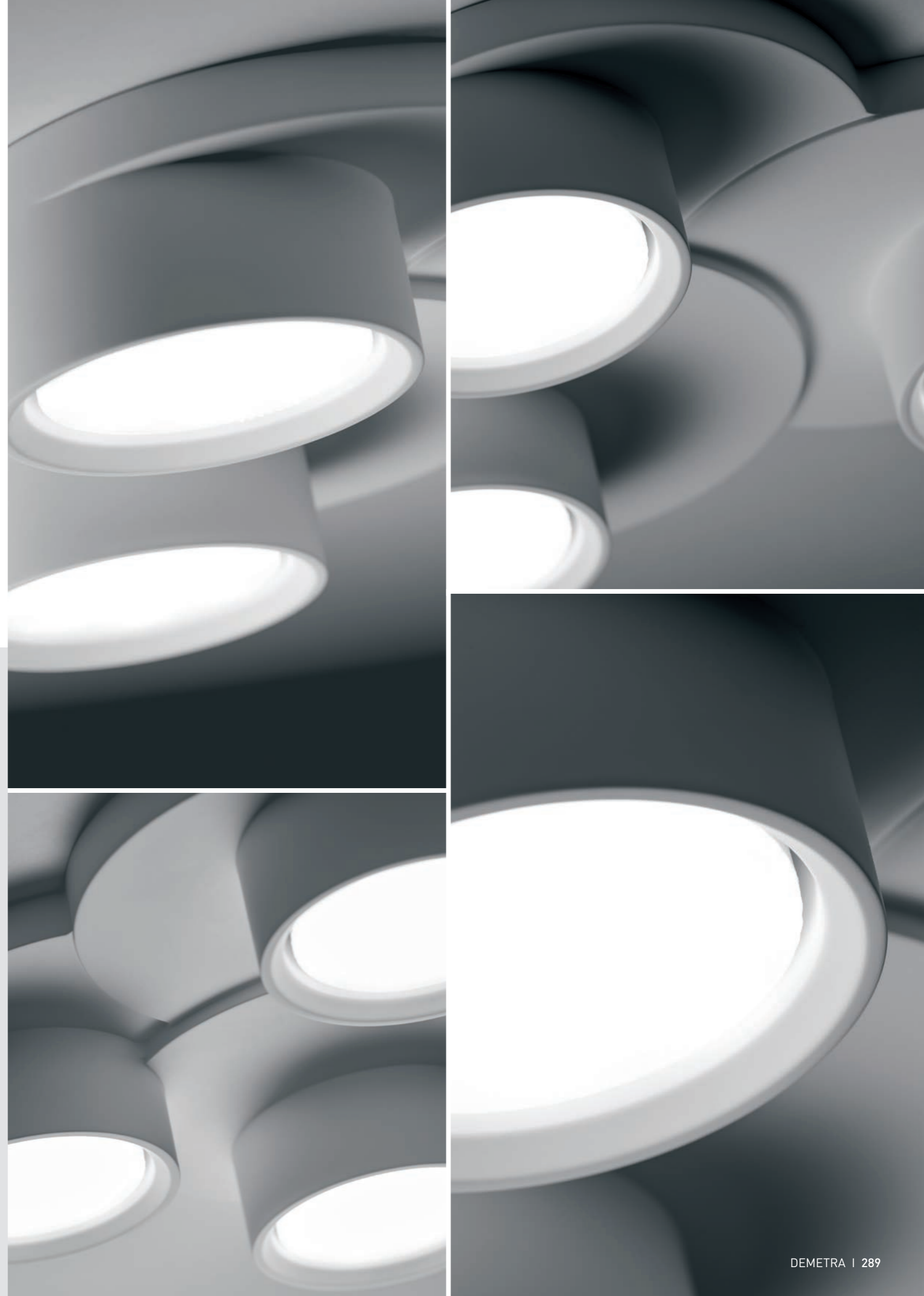
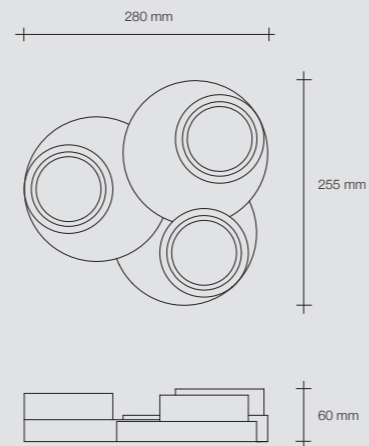



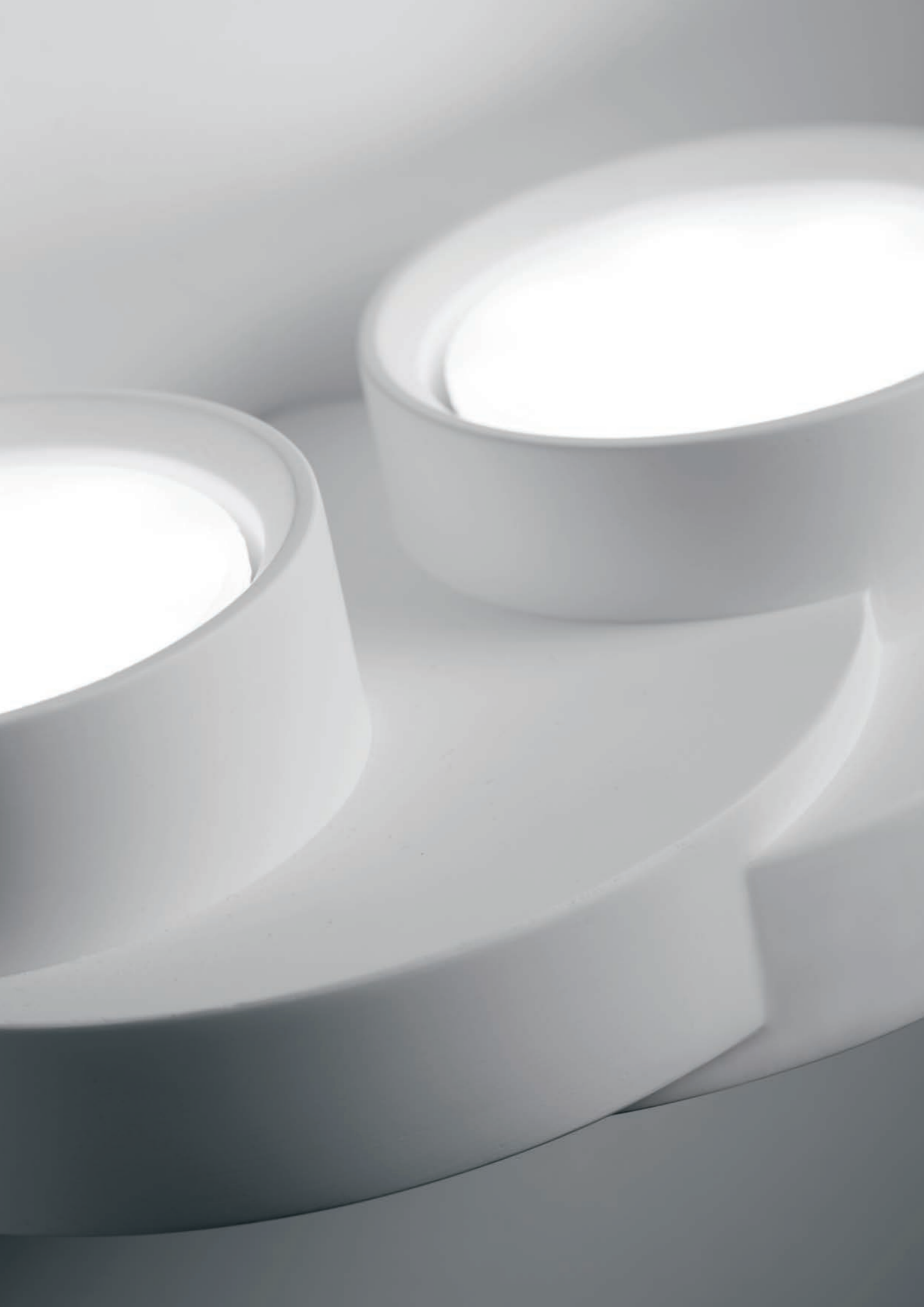





- Lampada da parete in gesso a una luce
- Per lampadine GX53
- Lampadine installabili: fluorescenti o led

- Plaster wall one-light lamp
- Designed for GX53 bulbs
- Bulbs: fluorescent or LED

- Wandleuchte aus Gips mit einem Leuchtmittel
- Für GX53 Leuchtmittel
- Installierbare Leuchtmittel: Leuchtstoff oder LED

- Luminaria para pared de yeso con una luz
- Para lámparas GX53
- Lámparas que se pueden instalar: fluorescentes o de LED

- Настенный гипсовый светильник с одной лампочкой
- Лампы с цоколем GX53
- Применяемые лампочки: флуоресцентные или светодиодные

Modello depositato

Registered design

Eingetragenes Modell

Modelo depositado

Зарегистрированная модель

Omologazioni

CE

Type-approvals

CE

Zulassungen

CE

Homologaciones

CE

Омологации

CE



T360



- GX53
- 1x10W

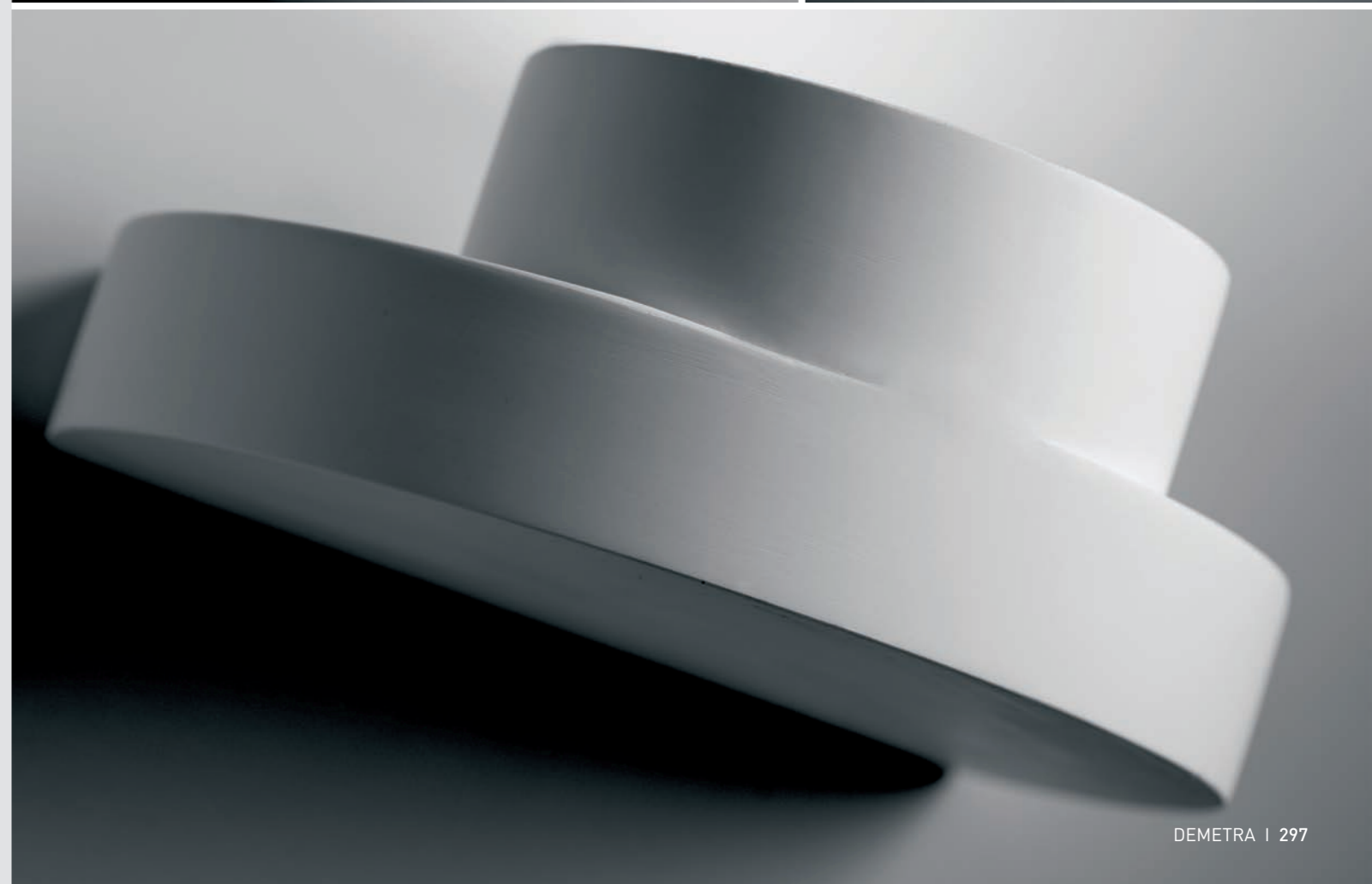
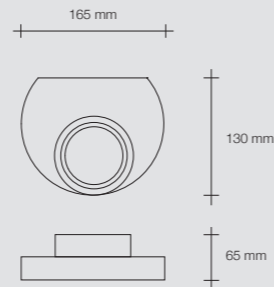



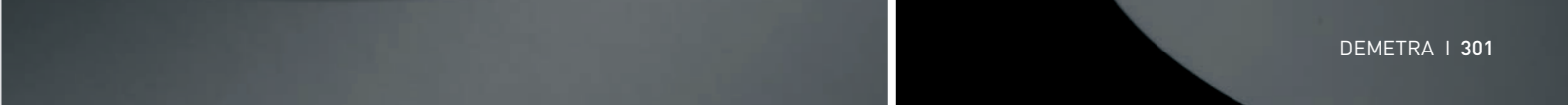

- Lampada da parete in gesso a due luci
- Per lampadine GX53
- Lampadine installabili: fluorescenti o led

- Plaster wall two-lights lamp
- For GX53 bulbs
- Bulbs: fluorescent or LED

- Wandleuchte aus Gips mit zwei Leuchtmitteln
- Für GX53 Leuchtmittel
- Installierbare Leuchtmittel: Leuchtstoff oder LED

- Luminaria para pared de yeso con dos luces
- Para lámparas GX53
- Lámparas que se pueden instalar: fluorescentes o de LED

- Настенный гипсовый светильник с двумя лампочками
- Лампы с цоколем GX53
- Применяемые лампочки: флуоресцентные или светодиодные

Modello depositato

Registered design

Eingetragenes Modell

Modelo depositado

Зарегистрированная модель

Omologazioni

CE

Type-approvals

CE

Zulassungen

CE

Homologaciones

CE

Омологации

CE

T361



- GX53
- 2x10W

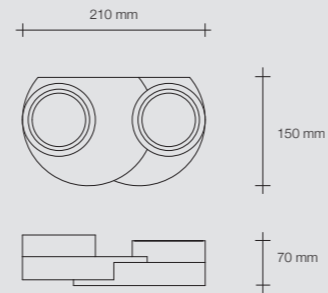





- Lampada da parete in gesso a due luci biemissiva
- Per lampadine GX53
- Lampadine installabili: fluorescenti o led

- Plaster wall two-lights lamp, double emission
- Designed for GX53 bulbs
- Bulbs: fluorescent or LED

- Wandleuchte aus Gips mit zwei Leuchtmitteln
- Für GX53 Leuchtmittel
- Installierbare Leuchtmittel: Leuchtstoff oder LED

- Luminaria para pared de yeso con dos luces, emisión doble
- Para lámparas GX53
- Lámparas que se pueden instalar: fluorescentes o de LED

- Двухнаправленный настенный гипсовый светильник с двумя лампочками
- Лампы с цоколем GX53
- Применяемые лампочки: флуоресцентные или светодиодные

Modello depositato

Registered design

Eingetragenes Modell

Modelo depositado

Зарегистрированная модель

Omologazioni

CE V A

Type-approvals

CE V A

Zulassungen

CE V A

Homologaciones

CE V A

Омологации

CE V A

T362



- GX53
- 2x10W

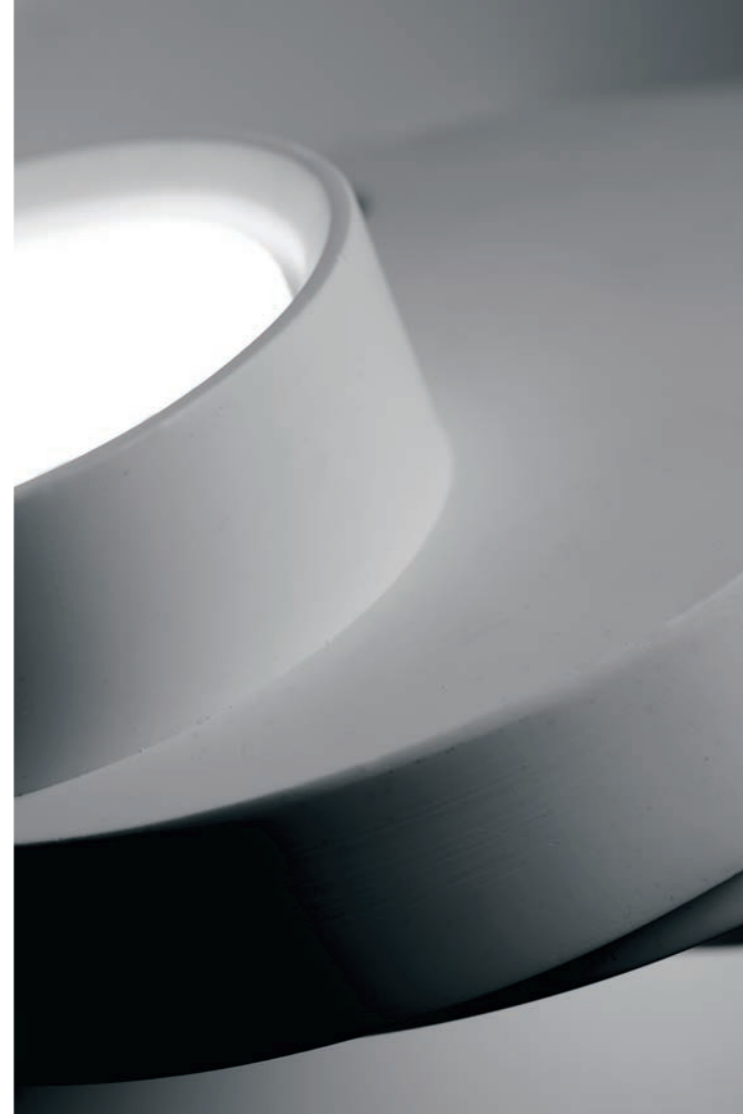
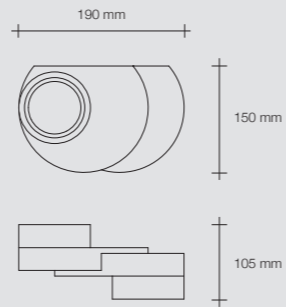





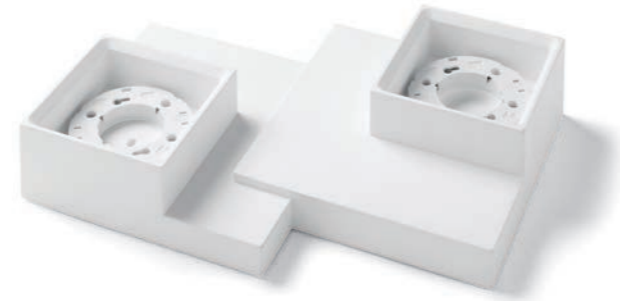
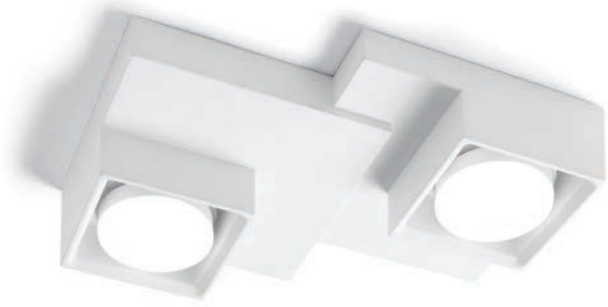

- Lampada a soffitto in gesso a due luci
- Per lampadine GX53
- Lampadine installabili: fluorescenti o led

- 2-light plaster ceiling light
- Designed for GX53 bulbs
- Bulbs: fluorescent or LED

- Deckenleuchte aus Gips mit zwei Lampen
- Für GX53 Leuchtmittel
- Installierbare Leuchtmittel: Leuchtstoff oder LED

- Lámpara de techo de yeso con dos luces
- Para lámparas GX53
- Lámparas que se pueden instalar: fluorescentes o de LED

- Потолочный гипсовый светильник с двумя лампочками
- Лампы с цоколем GX53
- Применяемые лампочки: флуоресцентные или светодиодные

Modello depositato

Registered design

Eingetragenes Modell

Modelo depositado

Зарегистрированная модель

Omologazioni

CE 

Type-approvals

CE 

Zulassungen

CE 

Homologaciones

CE 

Омологации

CE 



T377



- GX53
- 2x10W

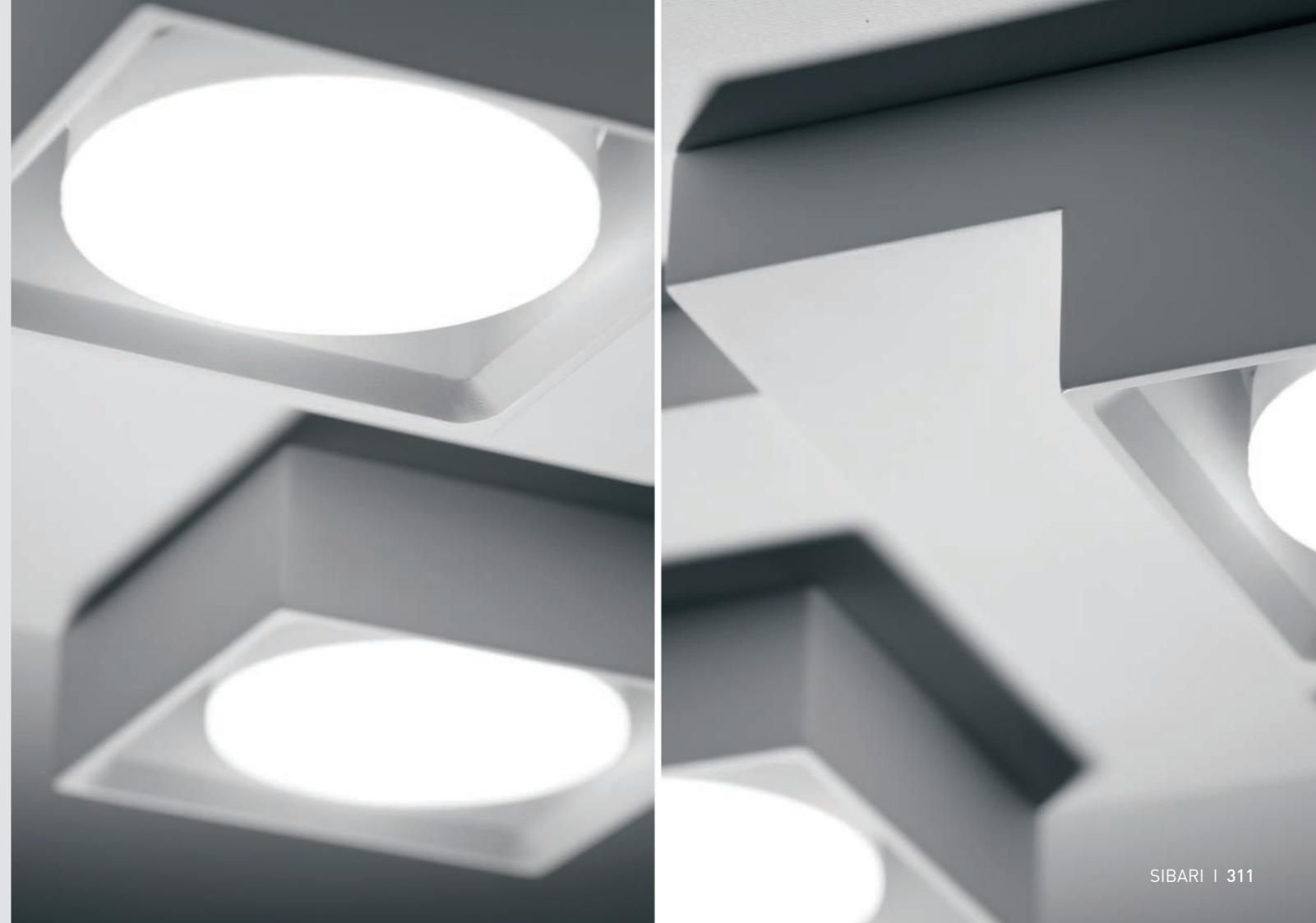
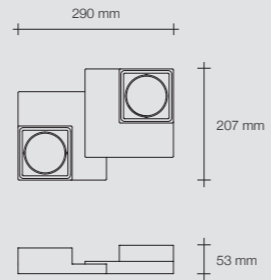





- Lampada a soffitto in gesso a tre luci
- Per lampadine GX53
- Lampadine installabili: fluorescenti o led

- 3-light plaster ceiling light
- Designed for GX53 bulbs
- Bulbs: fluorescent or LED

- Deckenleuchte aus Gips mit drei Lampen
- Für GX53 Leuchtmittel
- Installierbare Leuchtmittel: Leuchtstoff oder LED

- Lámpara de techo de yeso con tres luces
- Para lámparas GX53
- Lámparas que se pueden instalar: fluorescentes o de LED

- Потолочный гипсовый светильник с тремя лампочками
- Лампы с цоколем GX53
- Применяемые лампочки: флуоресцентные или светодиодные

Modello depositato

Registered design

Eingetragenes Modell

Modelo depositado

Зарегистрированная модель

Omologazioni



Type-approvals



Zulassungen



Homologaciones



Омолгации

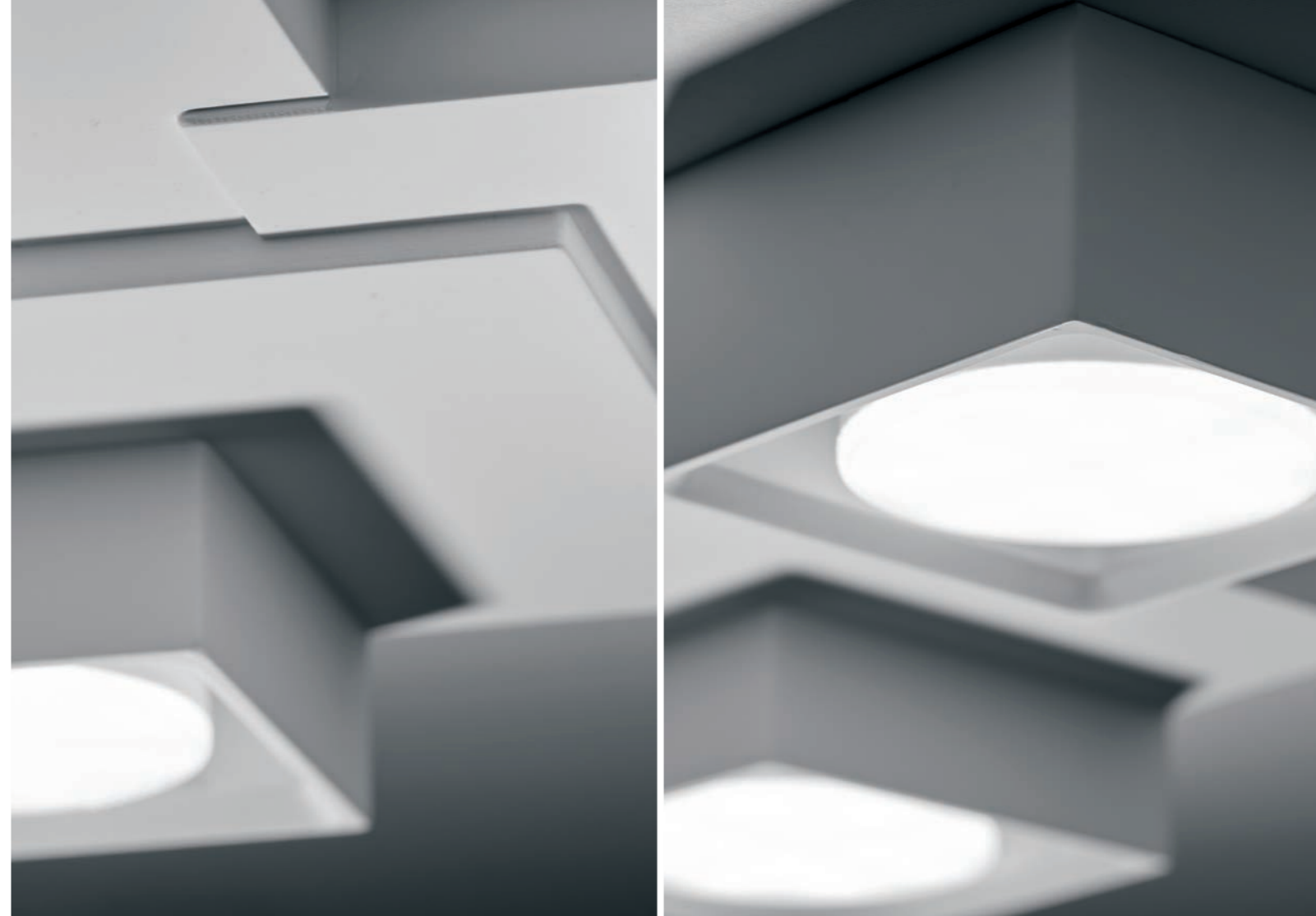

T378



- GX53
- 3x10W

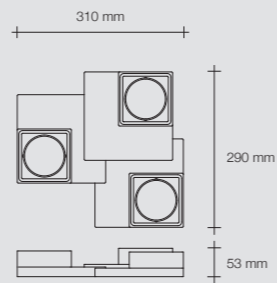





- Lampada da parete in gesso a una luce
- Per lampadine GX53
- Lampadine installabili: fluorescenti o led

- Plaster wall one-light lamp
- Designed for GX53 bulbs
- Bulbs: fluorescent or LED

- Wandleuchte aus Gips mit einem Leuchtmittel
- Für GX53 Leuchtmittel
- Installierbare Leuchtmittel: Leuchtstoff oder LED

- Luminaria para pared de yeso con una luz
- Para lámparas GX53
- Lámparas que se pueden instalar: fluorescentes o de LED

- Настенный гипсовый светильник с одной лампочкой
- Лампы с цоколем GX53
- Применяемые лампочки: флуоресцентные или светодиодные

Modello depositato

Registered design

Eingetragenes Modell

Modelo depositado

Зарегистрированная модель

Omologazioni

CE

Type-approvals

CE

Zulassungen

CE

Homologaciones

CE

Омологации

CE

T379



- GX53
- 1x10W

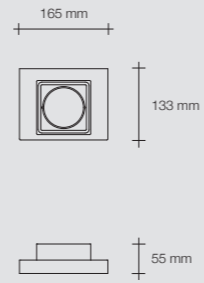



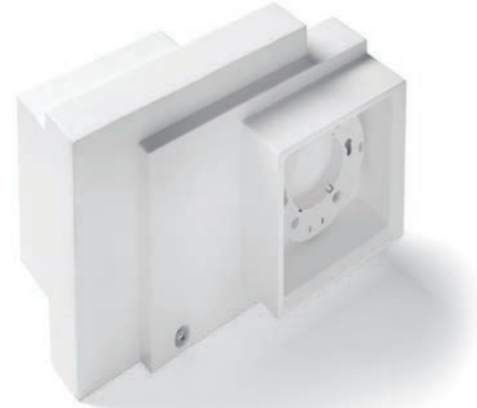

- Lampada da parete in gesso a due luci biemissiva
- Per lampadine GX53
- Lampadine installabili: fluorescenti o led

- Plaster wall two-lights lamp, double emission
- Designed for GX53 bulbs
- Bulbs: fluorescent or LED

- Wandleuchte aus Gips mit zwei Leuchtmitteln
- Für GX53 Leuchtmittel
- Installierbare Leuchtmittel: Leuchtstoff oder LED

- Luminaria para pared de yeso con dos luces, emisión doble
- Para lámparas GX53
- Lámparas que se pueden instalar: fluorescentes o de LED

- Двухнаправленный настенный гипсовый светильник с двумя лампочками
- Лампы с цоколем GX53
- Применяемые лампочки: флуоресцентные или светодиодные

Modello depositato

Registered design

Eingetragenes Modell

Modelo depositado

Зарегистрированная модель

Omologazioni



Type-approvals



Zulassungen



Homologaciones



Омологации



T380



- GX53
- 2x10W

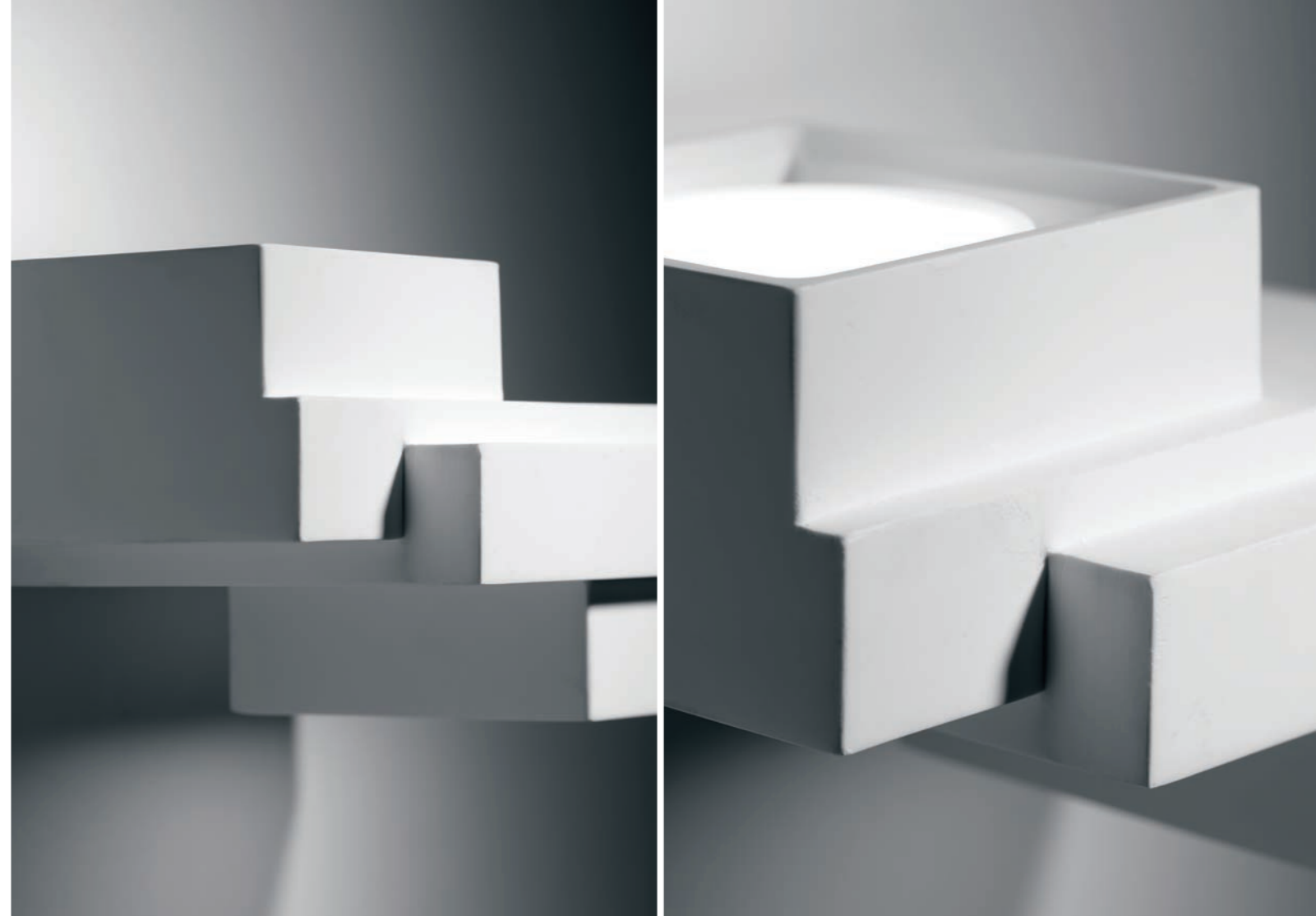
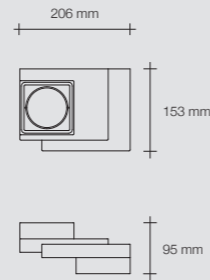









- Lampada a soffitto
in gesso ad una luce
- Per lampadine GX53
- Lampadine installabili:
fluorescenti o led

- Single-light plaster
ceiling light
- Designed for GX53 bulbs
- Bulbs: fluorescent or LED

- Deckenleuchte aus Gips
mit einer Lampe
- Für GX53 Leuchtmittel
- Installierbare Leuchtmittel:
Leuchtstoff oder LED

- Lámpara de techo de yeso
con una luz
- Para lámparas GX53
- Lámparas que se pueden
instalar: fluorescentes o
de LED

- Потолочный гипсовый светильник
с одной лампочкой
- Лампы с цоколем GX53
- Применяемые лампочки:
флуоресцентные или светодиодные

Modello depositato

Registered design

Eingetragenes Modell

Modelo depositado

Зарегистрированная модель

Omologazioni

CE V A

Type-approvals

CE V A

Zulassungen

CE V A

Homologaciones

CE V A

Омолгации

CE V A

T371



- GX53
- 1x10W

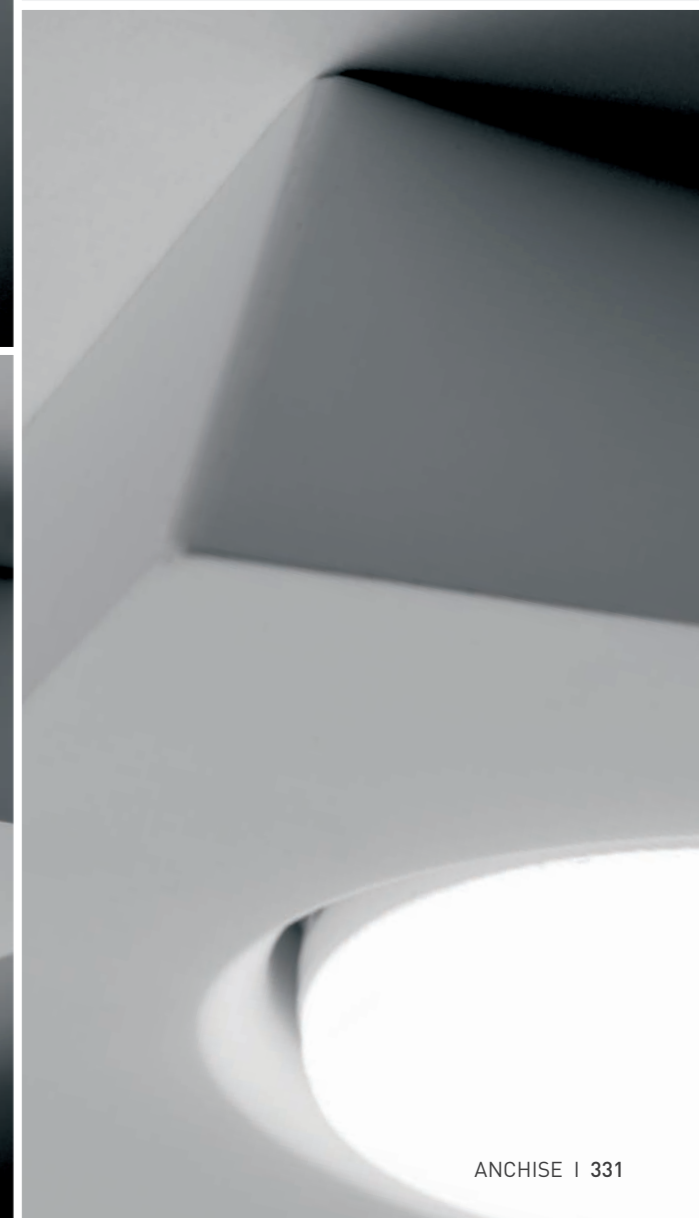
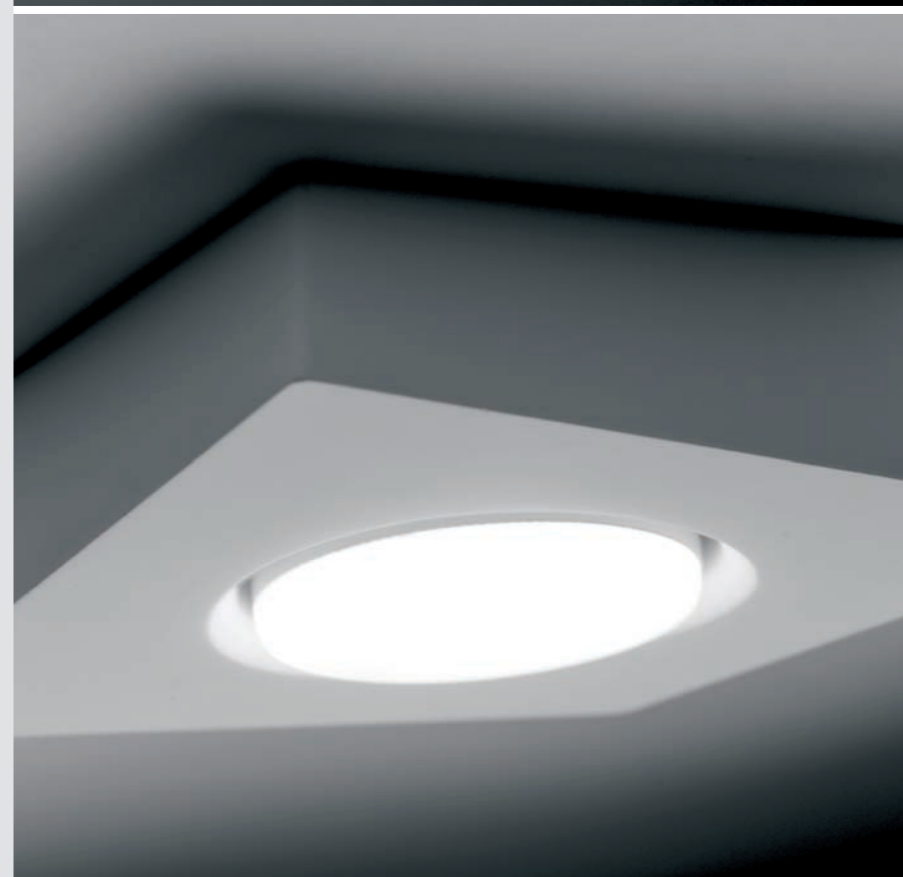
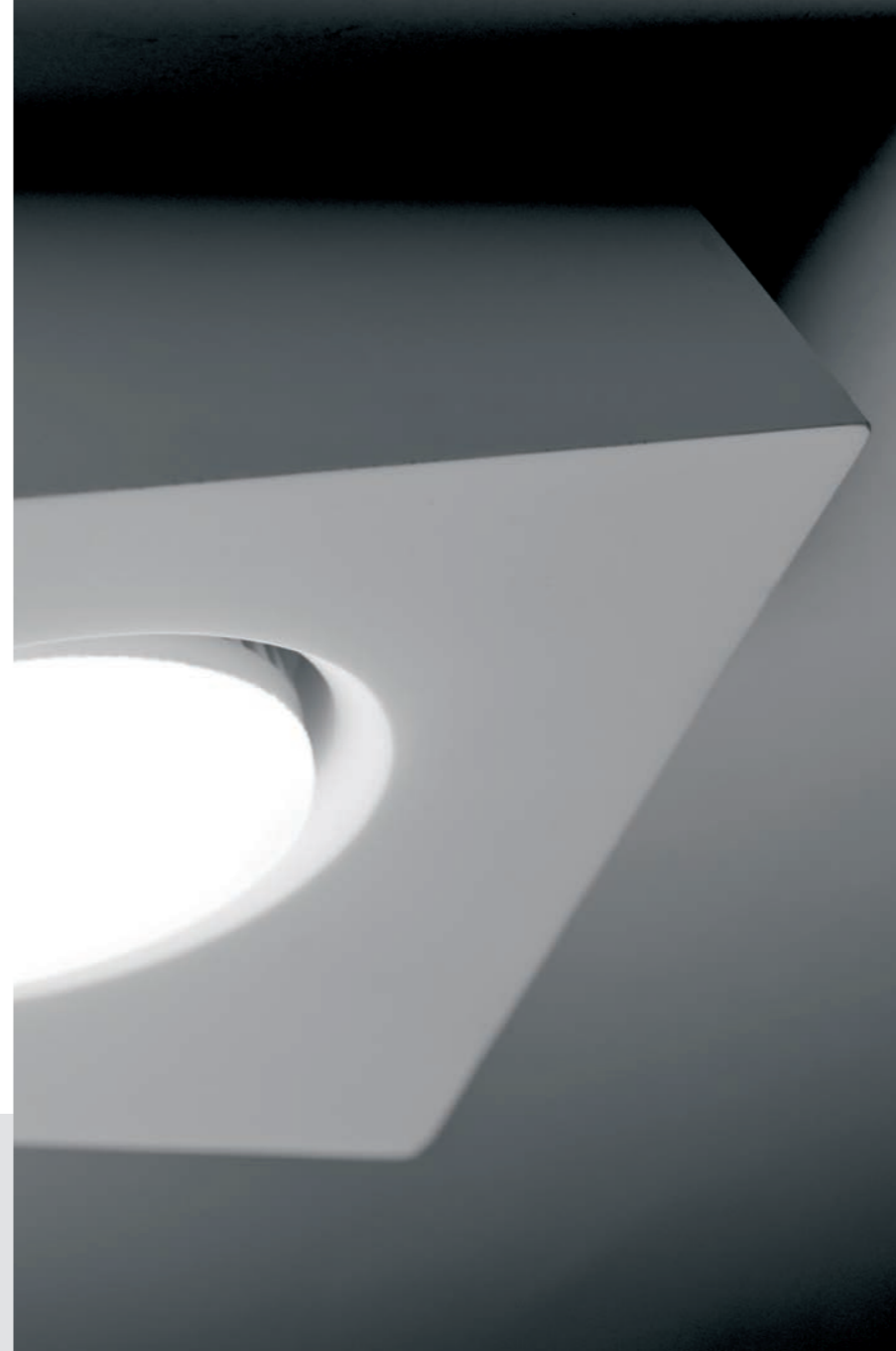
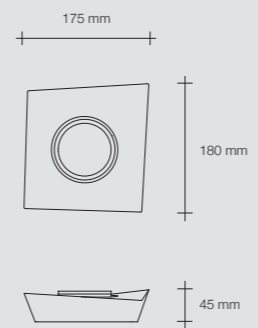





- Lampada a soffitto in gesso a due luci
- Per lampadine GX53
- Lampadine installabili: fluorescenti o led

- 2-light plaster ceiling light
- Designed for GX53 bulbs
- Bulbs: fluorescent or LED

- Deckenleuchte aus Gips mit zwei Lampen
- Für GX53 Leuchtmittel
- Installierbare Leuchtmittel: Leuchtstoff oder LED

- Lámpara de techo de yeso con dos luces
- Para lámparas GX53
- Lámparas que se pueden instalar: fluorescentes o de LED

- Потолочный гипсовый светильник с двумя лампочками
- Лампы с цоколем GX53
- Применяемые лампочки: флуоресцентные или светодиодные

Modello depositato

Registered design

Eingetragenes Modell

Modelo depositado

Зарегистрированная модель

Omologazioni

CE

Type-approvals

CE

Zulassungen

CE

Homologaciones

CE

Омологации

CE

T372



- GX53
- 2x10W

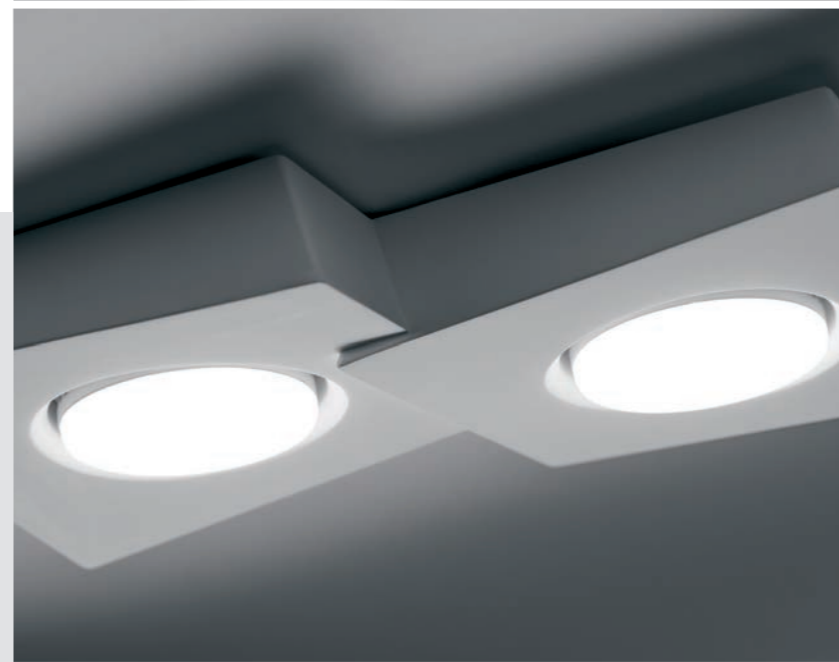
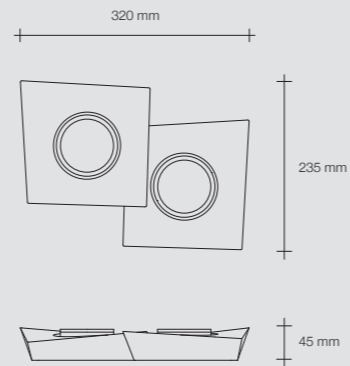





- Lampada a soffitto in gesso a tre luci
- Per lampadine GX53
- Lampadine installabili: fluorescenti o led

- 3-light plaster ceiling light
- Designed for GX53 bulbs
- Bulbs: fluorescent or LED

- Deckenleuchte aus Gips mit drei Lampen
- Für GX53 Leuchtmittel
- Installierbare Leuchtmittel: Leuchtstoff oder LED

- Lámpara de techo de yeso con tres luces
- Para lámparas GX53
- Lámparas que se pueden instalar: fluorescentes o de LED

- Потолочный гипсовый светильник с тремя лампочками
- Лампы с цоколем GX53
- Применяемые лампочки: флуоресцентные или светодиодные

Modello depositato

Registered design

Eingetragenes Modell

Modelo depositado

Зарегистрированная модель

Omologazioni



Type-approvals



Zulassungen



Homologaciones



Омолгации



T373



- GX53
- 3x10W

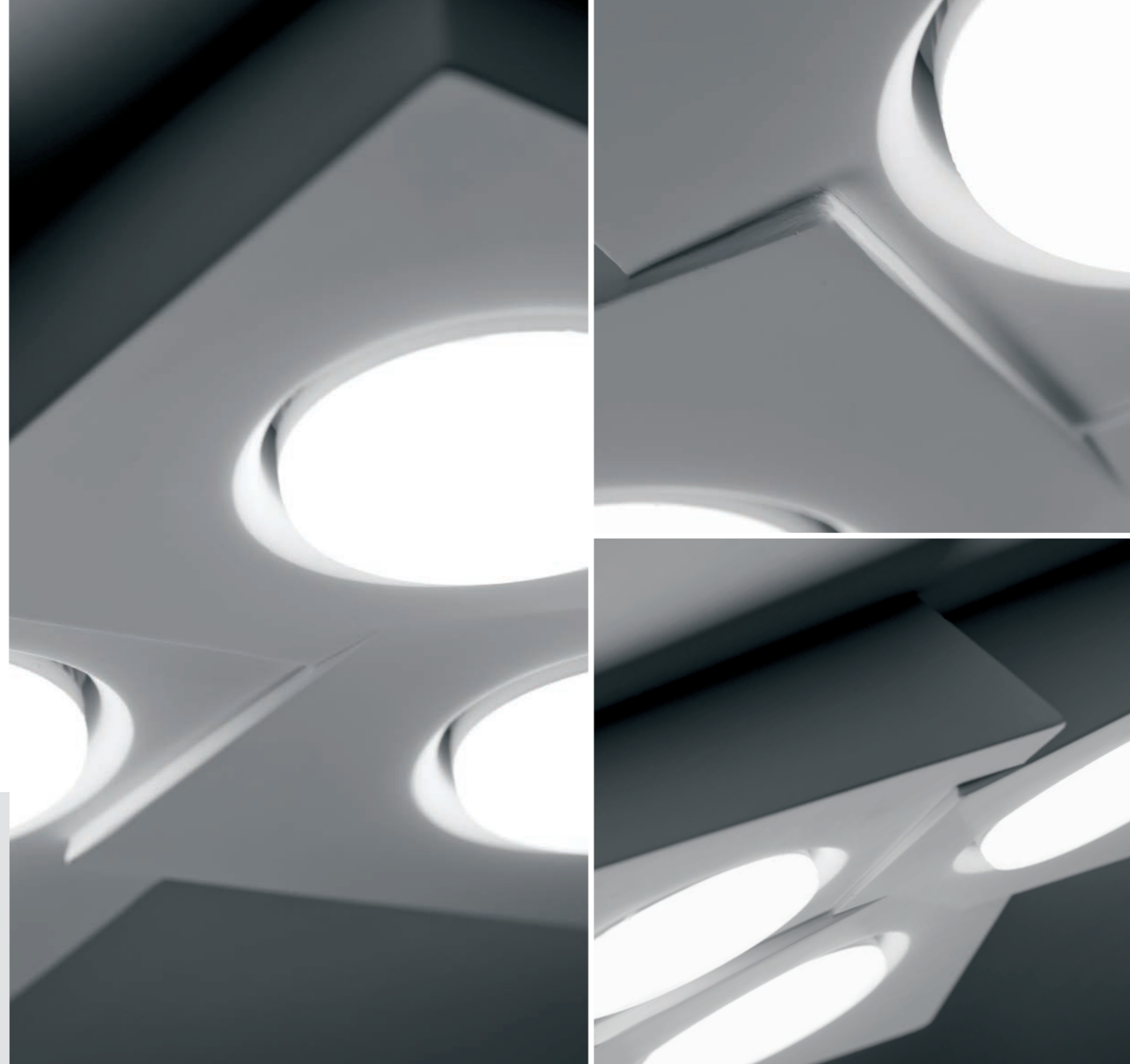
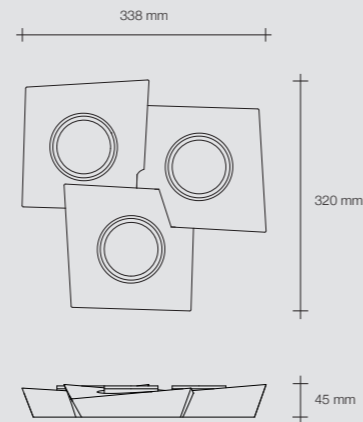





- Lampada a parete in gesso a una luce
- Per lampadine GX53
- Lampadine installabili: fluorescenti o led

- Plaster wall one-light lamp
- Designed for GX53 bulbs
- Bulbs: fluorescent or LED

- Wandleuchte aus Gips mit einem Leuchtmittel
- Für GX53 Leuchtmittel
- Installierbare Leuchtmittel: Leuchtstoff oder LED

- Luminaria para pared de yeso con una luz
- Para lámparas GX53
- Lámparas que se pueden instalar: fluorescentes o de LED

- Настенный гипсовый светильник с одной лампочкой
- Лампы с цоколем GX53
- Применяемые лампочки: флуоресцентные или светодиодные

Modello depositato

Registered design

Eingetragenes Modell

Modelo depositado

Зарегистрированная модель

Omologazioni

CE V ⊕

Type-approvals

CE V ⊕

Zulassungen

CE V ⊕

Homologaciones

CE V ⊕

Омологации

CE V ⊕

T374



- GX53
- 1x10W

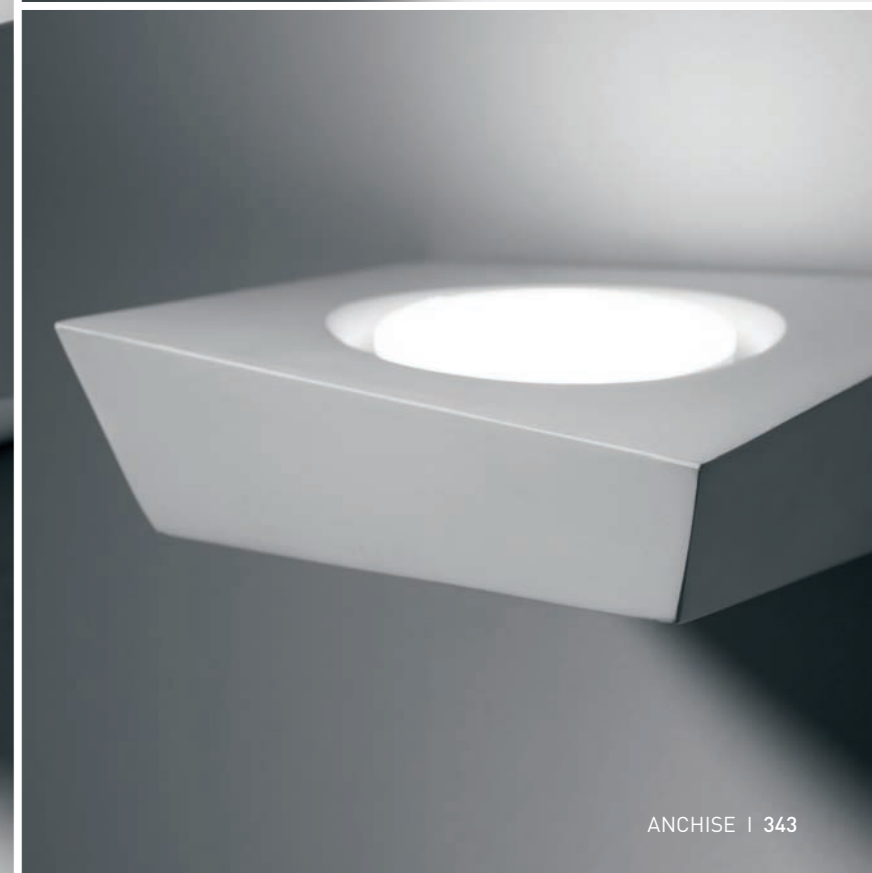
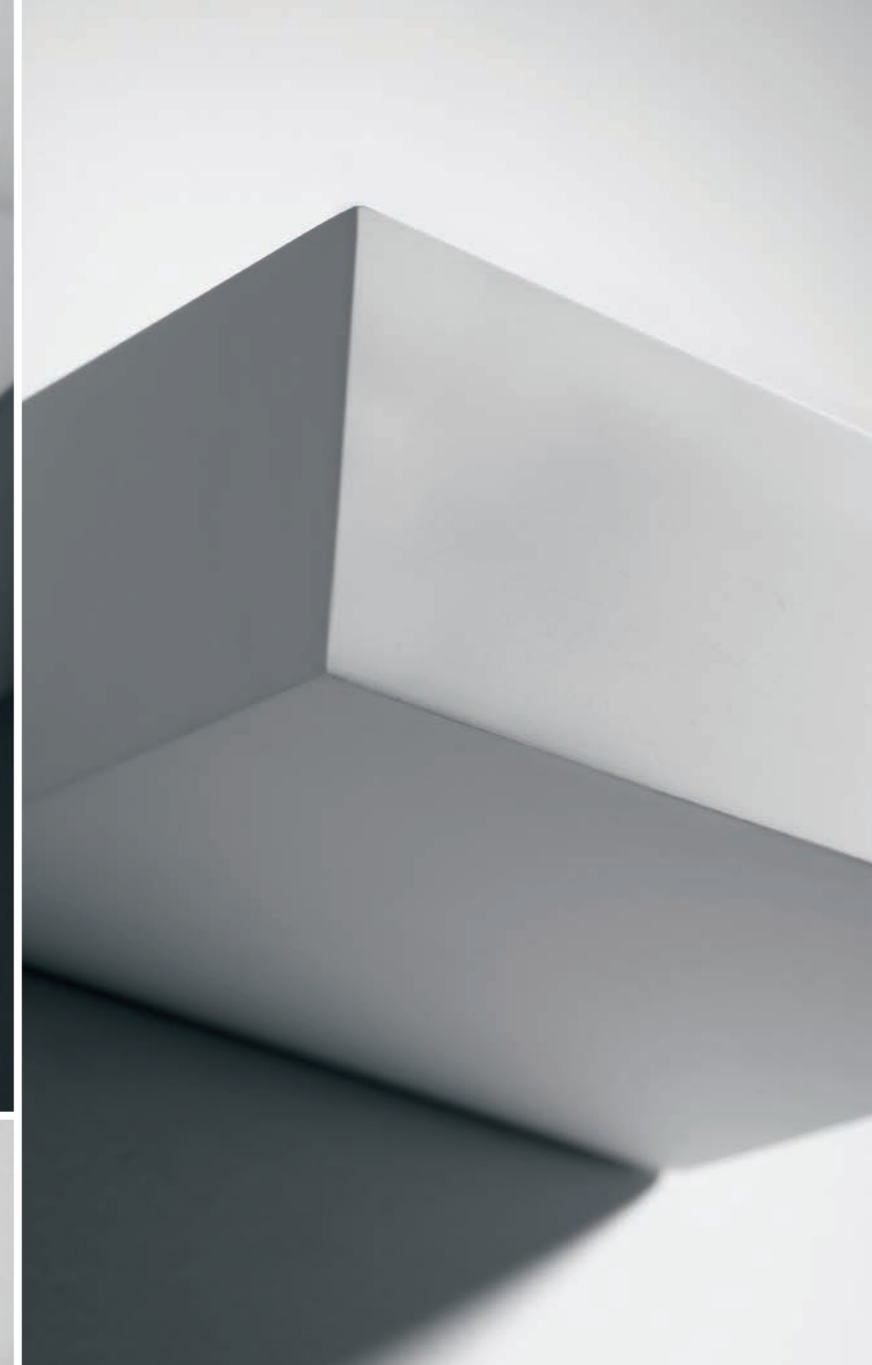
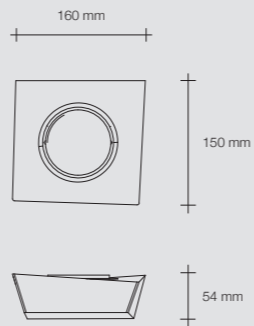





- Lampada a parete in gesso a due luci biemissiva
- Per lampadine GX53
- Lampadine installabili: fluorescenti o led

- Two-light bi-emission gypsum wall lamp
- For GX53 bulbs
- Bulbs: fluorescent or LED

- Wandleuchte für Gipskarton für zwei Doppellichtquellen
- Für GX53 Leuchtmittel
- Installierbare Leuchtmittel: Leuchtstoff oder LED

- Lámpara de pared de escayola con dos luces con doble emisión
- Para lámparas GX53
- Lámparas que se pueden instalar: fluorescentes o de LED

- Настенный точечный светильник из гипса с двумя источниками света с двойным излучением
- Лампы с цоколем GX53
- Применяемые лампочки: флуоресцентные или светодиодные

Modello depositato

Registered design

Eingetragenes Modell

Modelo depositado

Зарегистрированная модель

Omologazioni



Type-approvals



Zulassungen



Homologaciones



Омологации



T375



- GX53
- 2x10W

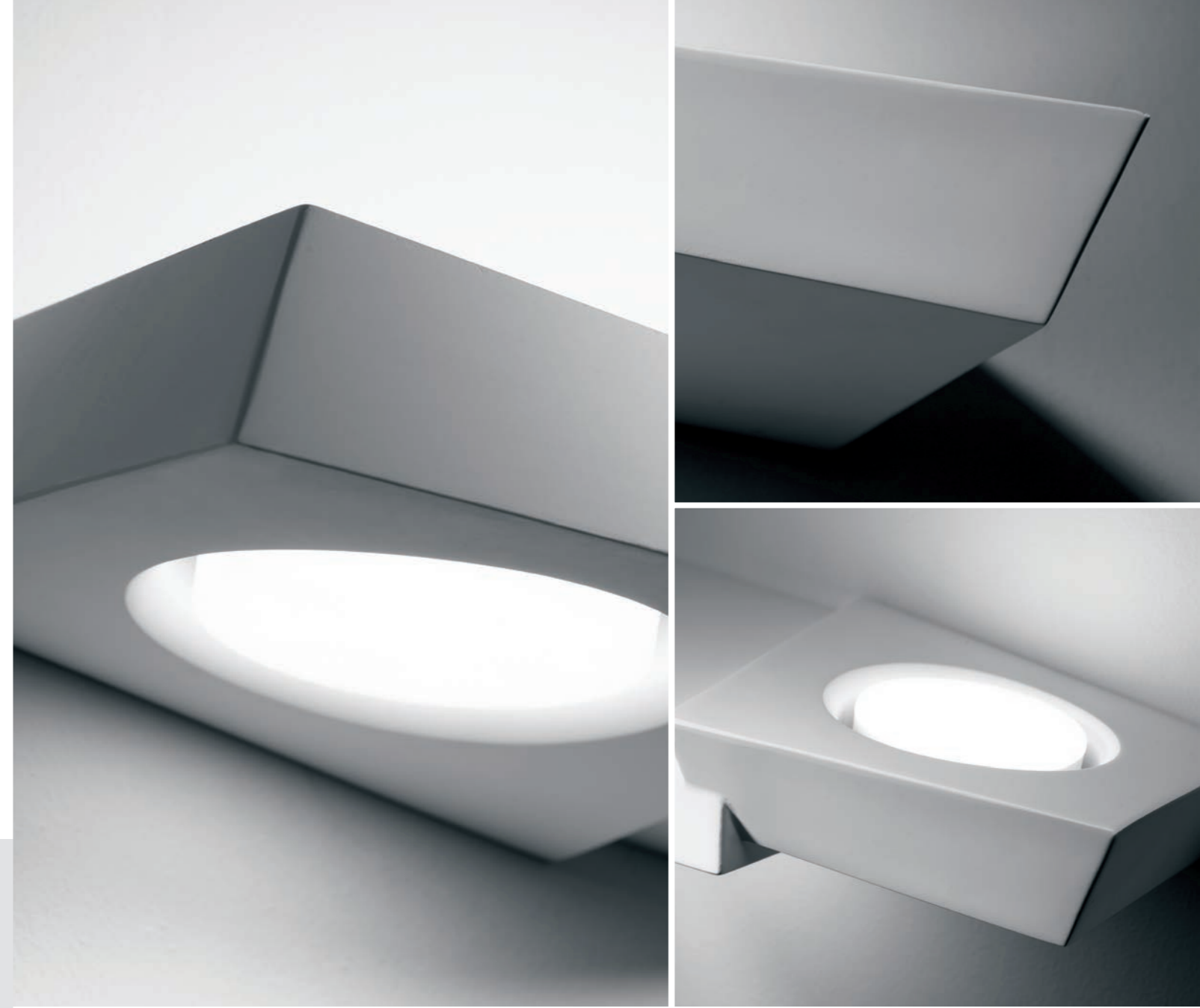
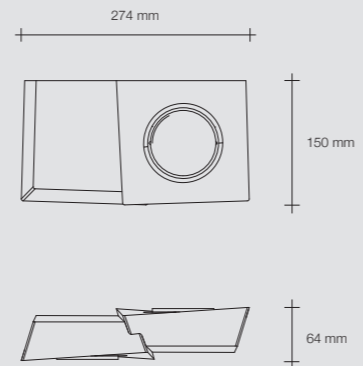





- Lampada a soffitto/parete in gesso ad una luce
- Lampadine installabili: fluorescenti o led

- Plaster ceiling/wall lamp with one light
- Bulb type: fluorescent or LED

- Decken-/Wandleuchte aus Gips und mit einer Lampe
- Installierbare Lampen: Leuchtstoff oder LED

- Lámpara de techo/pared de yeso con una luz
- Bombillas instalables: fluorescentes o led

- Гипсовый потолочный/настенный светильник с одной лампой
- Применяемые лампочки: флуоресцентные или светодиодные

Modello depositato

Registered design

Eingetragenes Modell

Modelo depositado

Зарегистрированная модель

Omologazioni

Type-approvals

Zulassungen

Homologaciones

Омологации

CE V A

CE V A

CE V A

CE V A

CE V A

T274



- GX53
- 1x10W

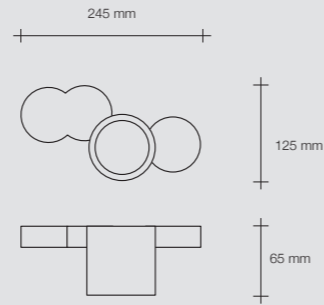



- Lampada a soffitto/parete in gesso a due luci
- Lampadine installabili: fluorescenti o led

- Plaster ceiling/wall lamp with two lights
- Bulb type: fluorescent or LED

- Decken-/Wandleuchte aus Gips und mit zwei Lampen
- Installierbare Lampen: Leuchtstoff oder LED

- Lámpara de techo/pared de yeso con dos luces
- Bombillas instalables: fluorescentes o led

- Гипсовый потолочный/настенный светильник с двумя лампами
- Применяемые лампочки: флуоресцентные или светодиодные

Modello depositato

Registered design

Eingetragenes Modell

Modelo depositado

Зарегистрированная модель

Omologazioni

Type-approvals

Zulassungen

Homologaciones

Омологации

CE V A

CE V A

CE V A

CE V A

CE V A

T278



- GX53
- 2x10W

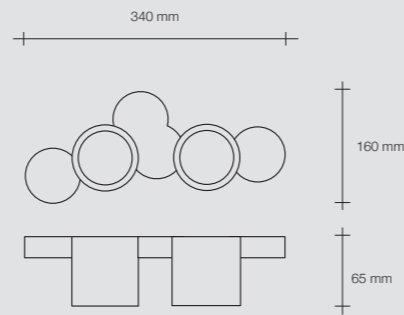



- Lampada a soffitto in gesso a tre luci
- Lampadine installabili: fluorescenti o led

- Plaster ceiling lamp with three lights
- Bulb type: fluorescent or LED

- Deckenleuchte aus Gips mit drei Lampen
- Installierbare Lampen: Leuchtstoff oder LED

- Lámpara de techo de yeso con tres luces
- Bombillas instalables: fluorescentes o led

- Гипсовый потолочный светильник с тремя лампами
- Применяемые лампочки: флуоресцентные или светодиодные

Modello depositato

Registered design

Eingetragenes Modell

Modelo depositado

Зарегистрированная модель

Omologazioni

Type-approvals

Zulassungen

Homologaciones

Омологации

CE V ⊕

CE V ⊕

CE V ⊕

CE V ⊕

CE V ⊕

T262



- GX53
- 3x10W

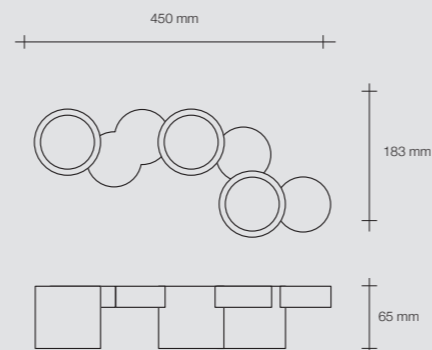



- Lampada a soffitto in gesso a tre luci
- Lampadine installabili: fluorescenti o led

- Plaster ceiling lamp with three lights
- Bulb type: fluorescent or LED

- Deckenleuchte aus Gips mit drei Lampen
- Installierbare Lampen: Leuchtstoff oder LED

- Lámpara de techo de yeso con tres luces
- Bombillas instalables: fluorescentes o led

- Гипсовый потолочный светильник с тремя лампами
- Применяемые лампочки: флуоресцентные или светодиодные

Modello depositato

Registered design

Eingetragenes Modell

Modelo depositado

Зарегистрированная модель

Omologazioni

Type-approvals

Zulassungen

Homologaciones

Омологации

CE V ⊕

CE V ⊕

CE V ⊕

CE V ⊕

CE V ⊕

T263



- GX53
- 3x10W

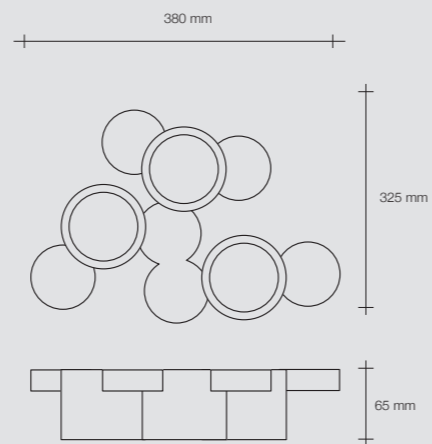



- L tallabili:
fluorescenti o led

- Plaster ceiling lamp
with five lights
- Bulb type:
fluorescent or LED

- Deckenleuchte aus Gips
mit fünf Lampen
- Installierbare Lampen:
Leuchtstoff oder LED

- Lámpara de techo de yeso
con cinco luces
- Bombillas instalables:
fluorescentes o led

- Гипсовый потолочный светильник с
пятью лампами
- Применяемые лампочки:
флуоресцентные или светодиодные

Modello depositato

Registered design

Eingetragenes Modell

Modelo depositado

Зарегистрированная модель

Omologazioni

Type-approvals

Zulassungen

Homologaciones

Омологации

CEV

CEV

CEV

CEV

CEV

T264



- GX53
- 5x10W

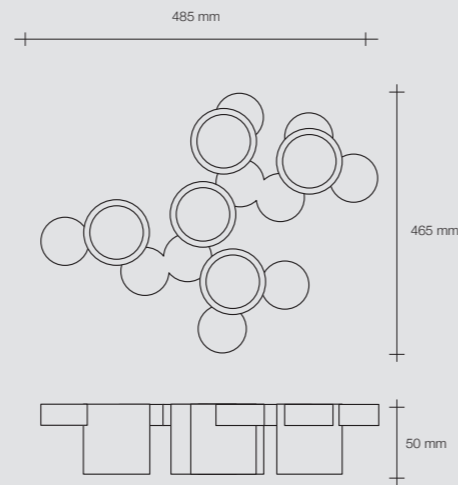

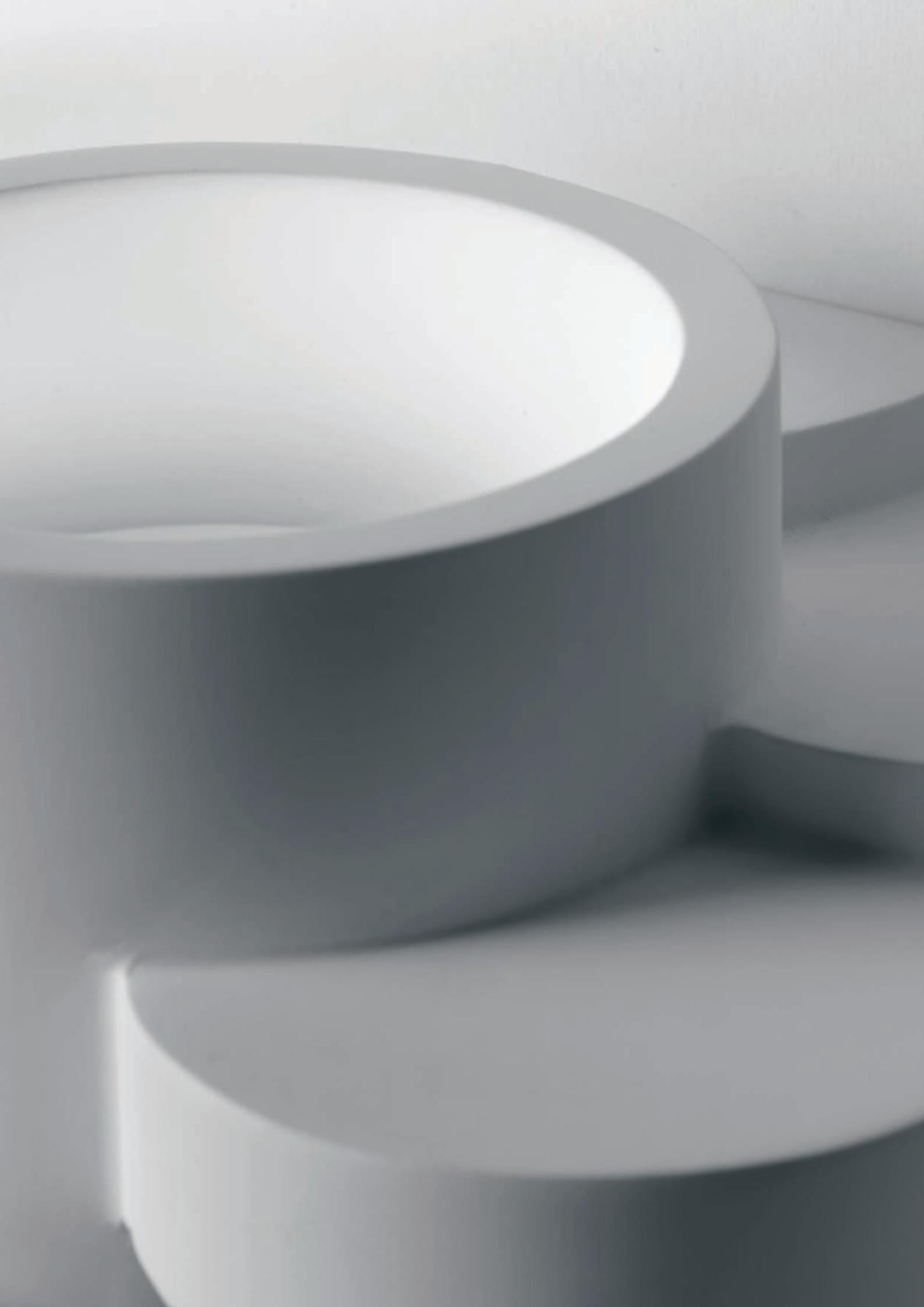





- Lampada a parete in gesso ad una luce
- Per lampadine GX53
- Lampadine installabili: fluorescenti o led

- Plaster wall one-light lamp
- Designed for GX53 bulbs
- Bulbs: fluorescent or LED

- Wandleuchte aus Gips mit einem Leuchtmittel
- Für GX53 Leuchtmittel
- Installierbare Leuchtmittel: Leuchtstoff oder LED

- Luminaria para pared de yeso con una luz
- Para lámparas GX53
- Lámparas que se pueden instalar: fluorescentes o de LED

- Настенный гипсовый светильник с одной лампочкой
- Лампы с цоколем GX53
- Применяемые лампочки: флуоресцентные или светодиодные

Modello depositato

Registered design

Eingetragenes Modell

Modelo depositado

Зарегистрированная модель

Omologazioni

CE V A

Type-approvals

CE V A

Zulassungen

CE V A

Homologaciones

CE V A

Омолгации

CE V A

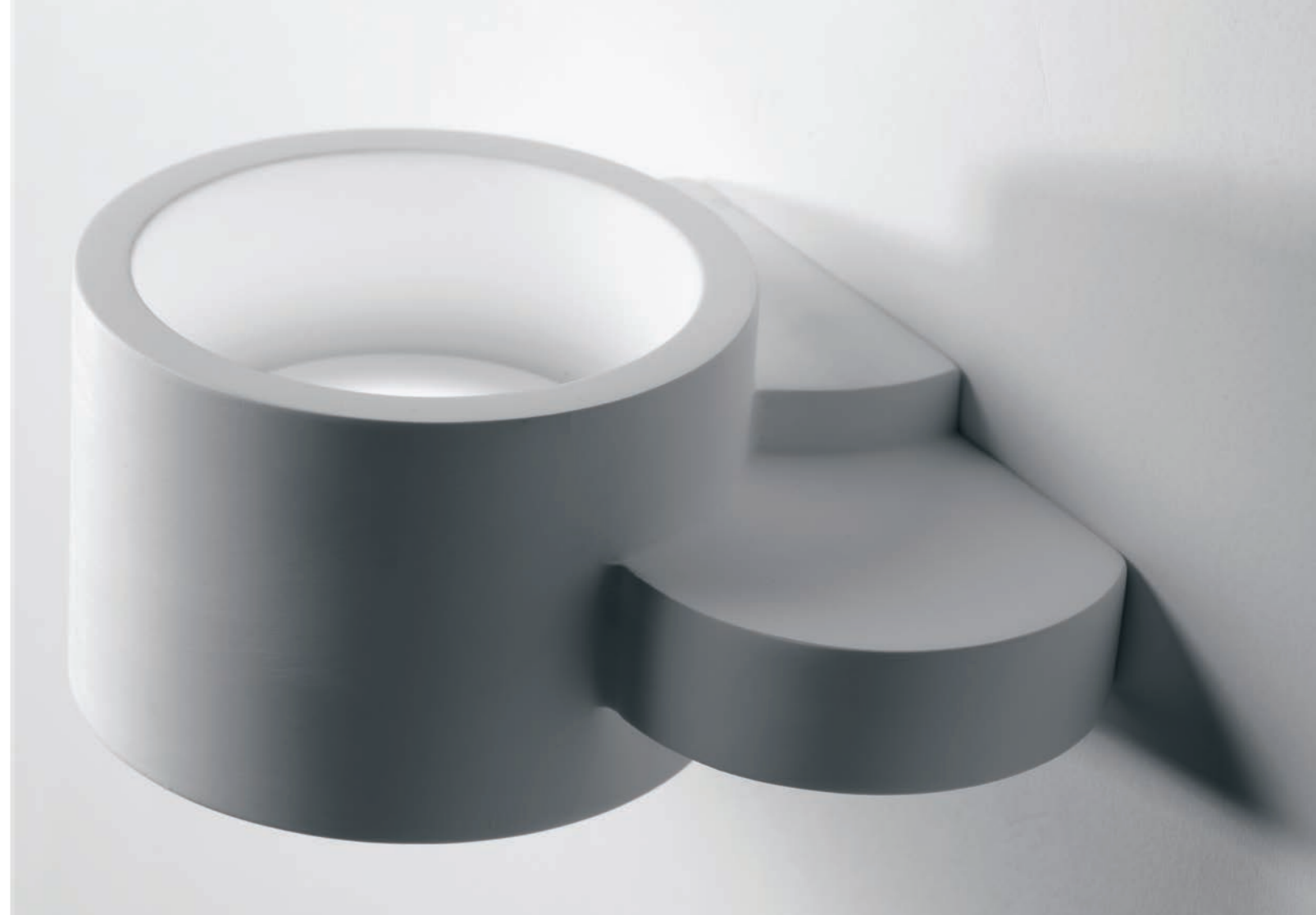

T319



- GX53
- 1x10W

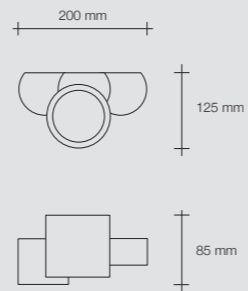





- Lampada a parete in gesso a due luci
- Per lampadine GX53
- Lampadine installabili: fluorescenti o led

- Plaster wall two-lights lamp
- For GX53 bulbs
- Bulbs: fluorescent or LED

- Wandleuchte aus Gips mit zwei Leuchtmitteln
- Für GX53 Leuchtmittel
- Installierbare Leuchtmittel: Leuchtstoff oder LED

- Luminaria para pared de yeso con dos luces
- Para lámparas GX53
- Lámparas que se pueden instalar: fluorescentes o de LED

- Настенный гипсовый светильник с двумя лампочками
- Лампы с цоколем GX53
- Применяемые лампочки: флуоресцентные или светодиодные

Modello depositato

Registered design

Eingetragenes Modell

Modelo depositado

Зарегистрированная модель

Omologazioni

CE V A

Type-approvals

CE V A

Zulassungen

CE V A

Homologaciones

CE V A

Омологации

CE V A

T320



- GX53
- 2x10W

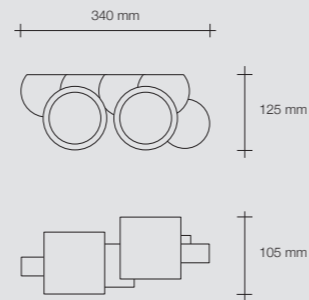





- Lampada a parete in gesso a due luci, biemissiva
- Per lampadine GX53
- Lampadine installabili: fluorescenti o led

- Plaster wall two-lights lamp, double emission
- Designed for GX53 bulbs
- Bulbs: fluorescent or LED

- Wandleuchte aus Gips mit zwei Leuchtmitteln
- Für GX53 Leuchtmittel
- Installierbare Leuchtmittel: Leuchtstoff oder LED

- Luminaria para pared de yeso con dos luces, emisión doble
- Para lámparas GX53
- Lámparas que se pueden instalar: fluorescentes o de LED

- Двухнаправленный настенный гипсовый светильник с двумя лампочками
- Лампы с цоколем GX53
- Применяемые лампочки: флуоресцентные или светодиодные

Modello depositato

Registered design

Eingetragenes Modell

Modelo depositado

Зарегистрированная модель

Omologazioni

CE V A

Type-approvals

CE V A

Zulassungen

CE V A

Homologaciones

CE V A

Омологации

CE V A



T321



- GX53
- 2x10W

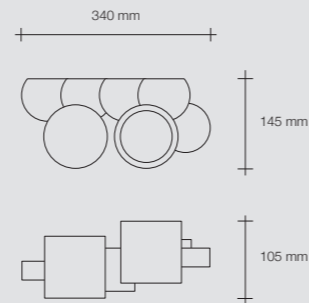





- Lampada da parete in gesso a tre luci biemissiva
- Per lampadine GX53
- Lampadine installabili: fluorescenti o led

- Plaster three-lights double-emission lamp
- Designed for GX53 bulbs
- Bulbs: fluorescent or LED

- Wandleuchte aus Gips mit zwei Leuchtmitteln, Bi-Emissions-Licht
- Für GX53 Leuchtmittel
- Installierbare Leuchtmittel: Leuchtstoff oder LED

- Luminaria para pared de yeso con tres luces, emisión doble
- Para lámparas GX53
- Lámparas que se pueden instalar: fluorescentes o de LED

- Двухнаправленный настенный гипсовый светильник с тремя лампочками
- Лампы с цоколем GX53
- Применяемые лампочки: флуоресцентные или светодиодные

Modello depositato

Registered design

Eingetragenes Modell

Modelo depositado

Зарегистрированная модель

Omologazioni

CE V A

Type-approvals

CE V A

Zulassungen

CE V A

Homologaciones

CE V A

Омологации

CE V A



T322



- GX53
- 3x10W

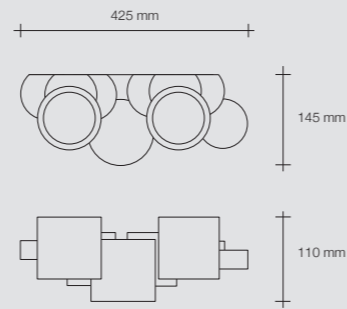

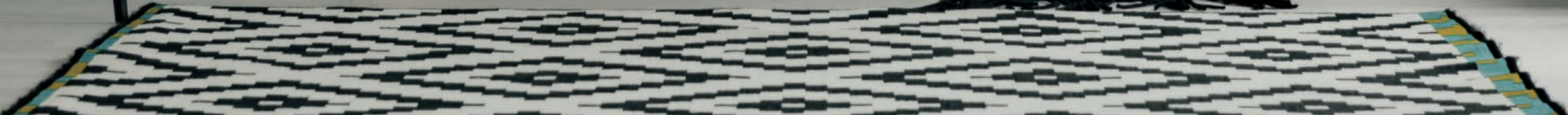

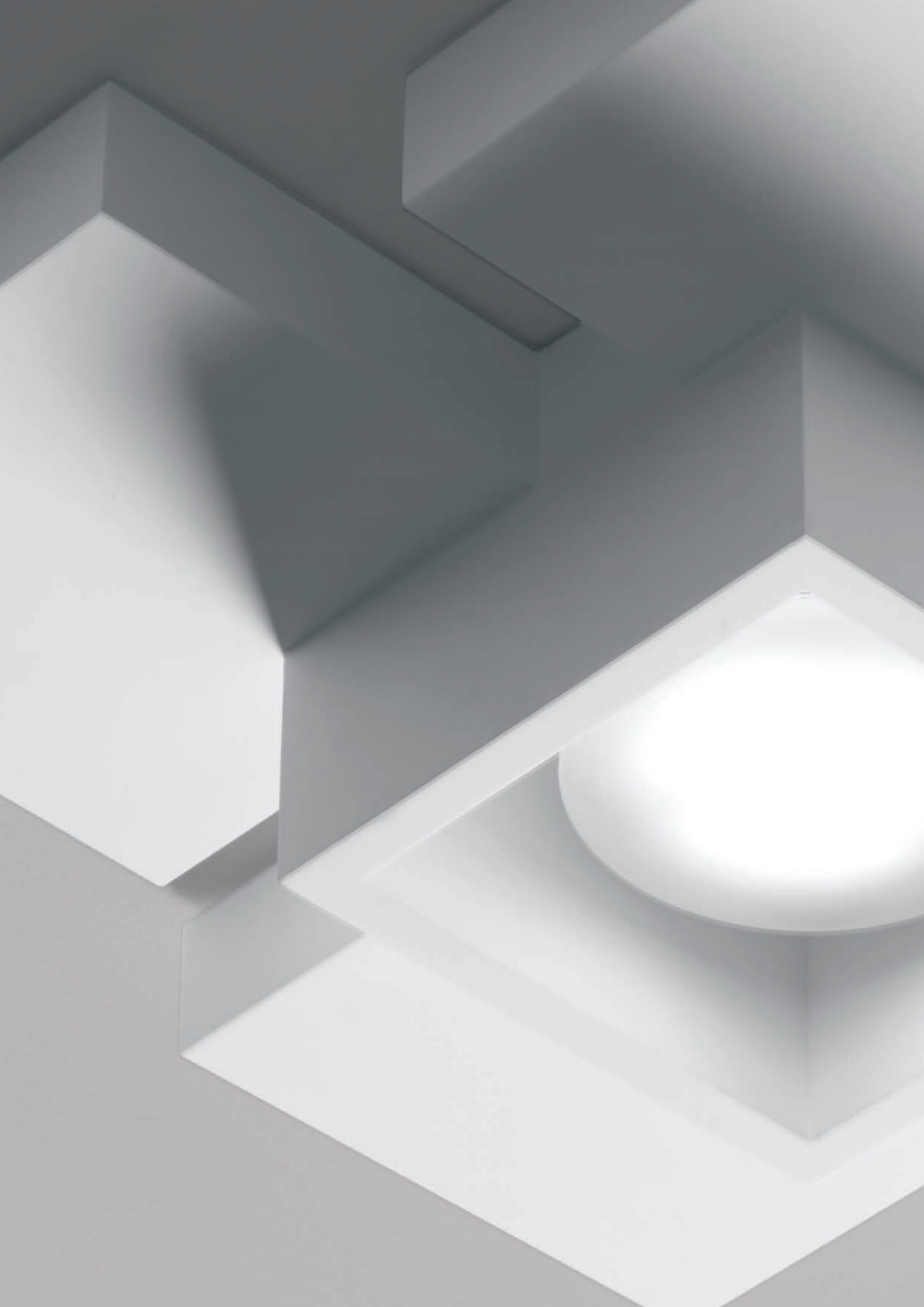

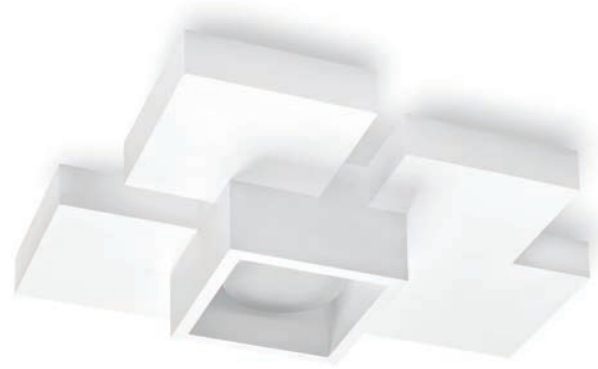

- Lampada da soffitto/parete
in gesso a una luce
- Lampadine installabili:
fluorescenti o led

- Plaster ceiling/wall lamp
with one light
- Bulb type:
fluorescent or LED

- Decken-/Wandleuchte
aus Gips und mit einer Lampe
- Installierbare Lampen:
Leuchtstoff oder LED

- Lámpara de techo/pared
de yeso con una luz
- Bombillas instalables:
fluorescentes o led

- Гипсовый потолочный/настенный
светильник с одной лампой
- Применяемые лампочки:
флуоресцентные или светодиодные

Modello depositato

Registered design

Eingetragenes Modell

Modelo depositado

Зарегистрированная модель

Omologazioni

Type-approvals

Zulassungen

Homologaciones

Омологации



T291



- GX53
- 1x10W

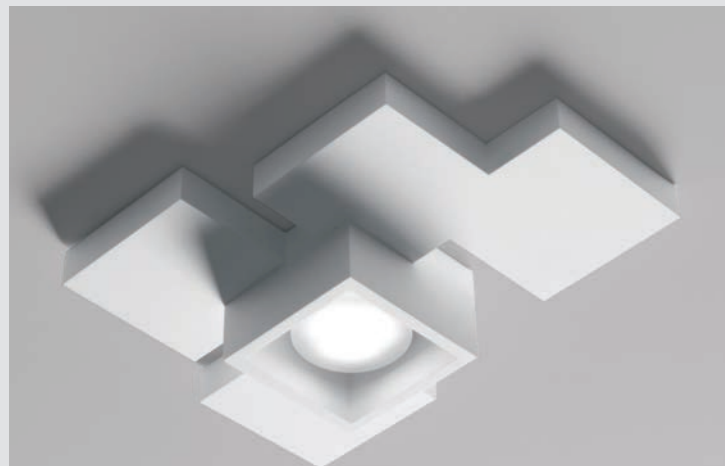
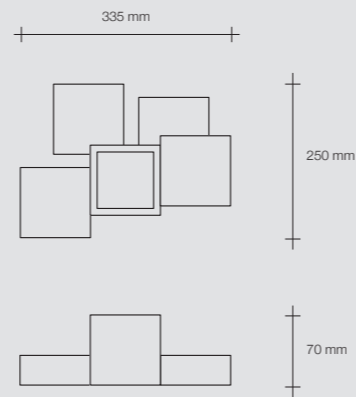

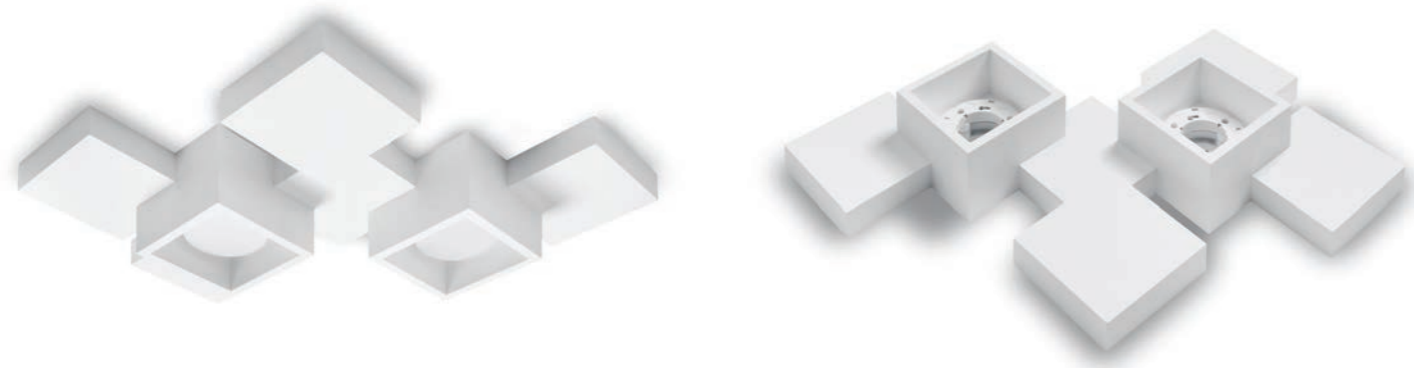

- Lampada da soffitto/parete in gesso a due luci
- Lampadine installabili: fluorescenti o led

- Plaster ceiling/wall lamp with two lights
- Bulb type: fluorescent or LED

- Decken/Wandleuchte aus Gips mit zwei Lampen
- Installierbare Lampen: Leuchtstoff oder LED

- Lámpara de techo/pared de yeso con dos luces
- Bombillas instalables: fluorescentes o led

- Гипсовый потолочный/настенный светильник с двумя лампочками
- Применяемые лампочки: флуоресцентные или светодиодные

Modello depositato

Registered design

Eingetragenes Modell

Modelo depositado

Зарегистрированная модель

Omologazioni

Type-approvals

Zulassungen

Homologaciones

Омологации



T292



- GX53
- 2x10W

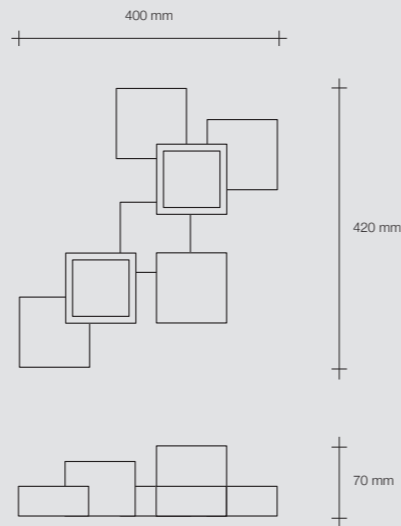

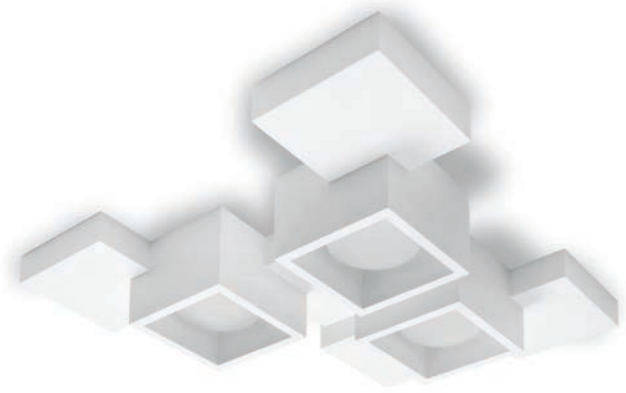

- Lampada da soffitto/parete
in gesso a tre luci
- Lampadine installabili:
fluorescenti o led

- Plaster ceiling/wall lamp
with three lights
- Bulb type:
fluorescent or LED

- Decken/Wandleuchte
aus Gips mit drei Lampen
- Installierbare Lampen:
Leuchtstoff oder LED

- Lámpara de techo/pared
de yeso con tres luces
- Bombillas instalables:
fluorescentes o led

- Гипсовый потолочный/настенный
светильник с тремя лампочками.
- Применяемые лампочки:
флуоресцентные или светодиодные

Modello depositato

Registered design

Eingetragenes Modell

Modelo depositado

Зарегистрированная модель

Omologazioni



Type-approvals



Zulassungen



Homologaciones



Омологации



T293



- GX53
- 3x10W

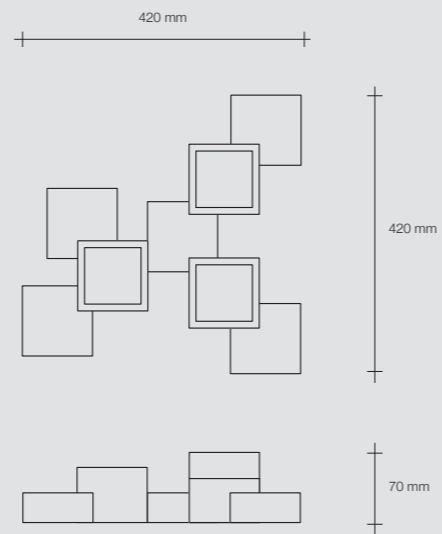





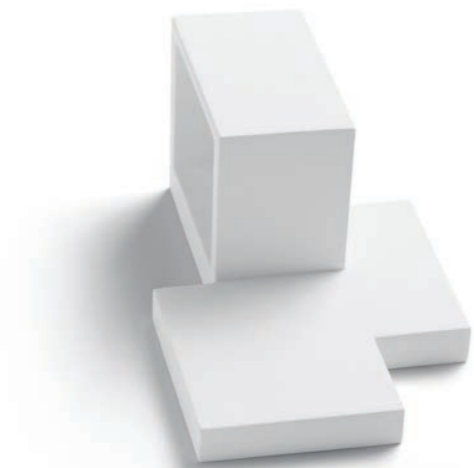

- Lampada a parete in gesso ad una luce
- Per lampadine GX53
- Lampadine installabili: luorescenti o led

- Plaster wall one-light lamp
- Designed for GX53 bulbs
- Bulbs: fluorescent or LED

- Wandleuchte aus Gips mit einem Leuchtmittel
- Für GX53 Leuchtmittel
- Installierbare Leuchtmittel: Leuchtstoff oder LED

- Luminaria para pared de yeso con una luz
- Para lámparas GX53
- Lámparas que se pueden instalar: fluorescentes o de LED

- Настенный гипсовый светильник с одной лампочкой
- Лампы с цоколем GX53
- Применяемые лампочки: флуоресцентные или светодиодные

Modello depositato

Registered design

Eingetragenes Modell

Modelo depositado

Зарегистрированная модель

Omologazioni

CE V A

Type-approvals

CE V A

Zulassungen

CE V A

Homologaciones

CE V A

Омологации

CE V A



T323



- GX53
- 1x10W

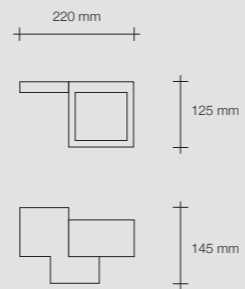



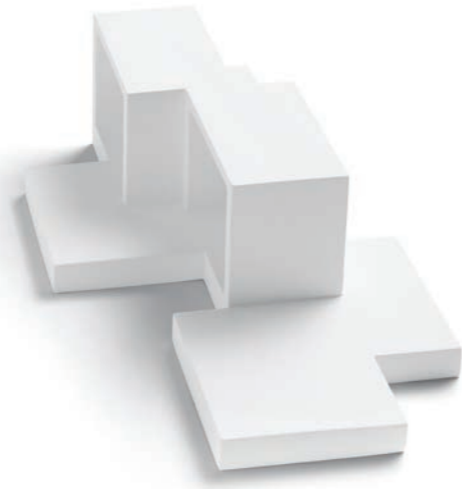
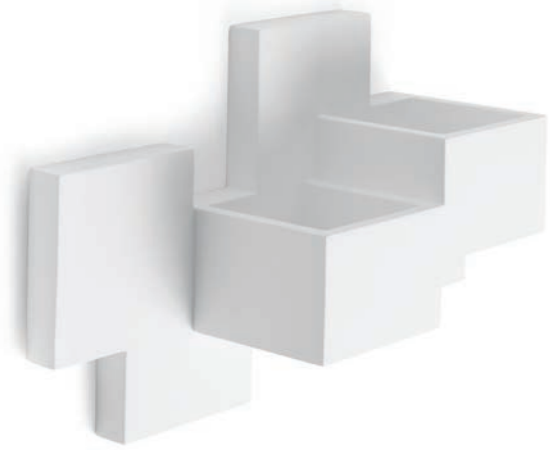

- Lampada a parete in gesso a due luci
- Per lampadine GX53
- Lampadine installabili: fluorescenti o led

- Plaster wall two-lights lamp
- For GX53 bulbs
- Bulbs: fluorescent or LED

- Wandleuchte aus Gips mit zwei Leuchtmitteln
- Für GX53 Leuchtmittel
- Installierbare Leuchtmittel: Leuchtstoff oder LED

- Luminaria para pared de yeso con dos luces
- Para lámparas GX53
- Lámparas que se pueden instalar: fluorescentes o de LED

- Настенный гипсовый светильник с двумя лампочками
- Лампы с цоколем GX53
- Применяемые лампочки: флуоресцентные или светодиодные

Modello depositato

Registered design

Eingetragenes Modell

Modelo depositado

Зарегистрированная модель

Omologazioni



Type-approvals



Zulassungen



Homologaciones



Омологации



T324



- GX53
- 2x10W

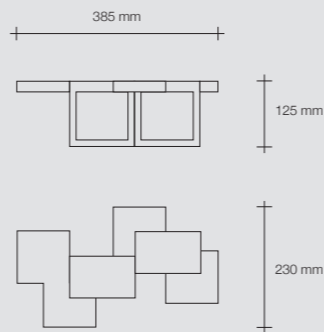

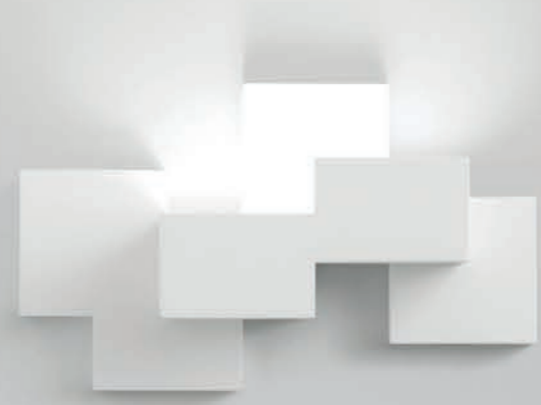

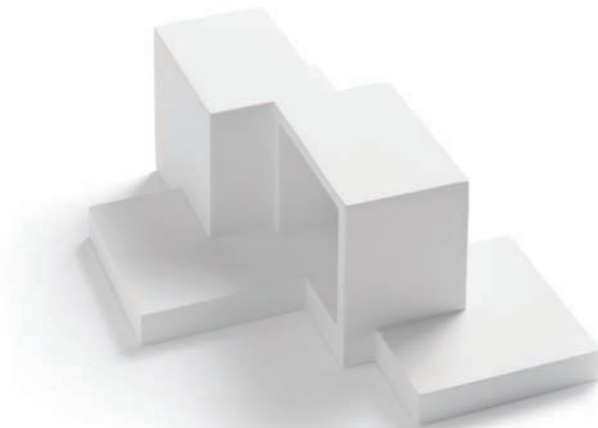

- Lampada a parete in gesso a due luci, biemissiva
- Per lampadine GX53
- Lampadine installabili: fluorescenti o led

- Plaster wall two-lights lamp, double emission
- Designed for GX53 bulbs
- Bulbs: fluorescent or LED

- Wandleuchte aus Gips mit zwei Leuchtmitteln
- Für GX53 Leuchtmittel
- Installierbare Leuchtmittel: Leuchtstoff oder LED

- Luminaria para pared de yeso con dos luces, emisión doble
- Para lámparas GX53
- Lámparas que se pueden instalar: fluorescentes o de LED

- Двухнаправленный настенный гипсовый светильник с двумя лампочками
- Лампы с цоколем GX53
- Применяемые лампочки: флуоресцентные или светодиодные

Modello depositato

Registered design

Eingetragenes Modell

Modelo depositado

Зарегистрированная модель

Omologazioni

CE V @

Type-approvals

CE V @

Zulassungen

CE V @

Homologaciones

CE V @

Омологации

CE V @

T325



- GX53
- 2x10W

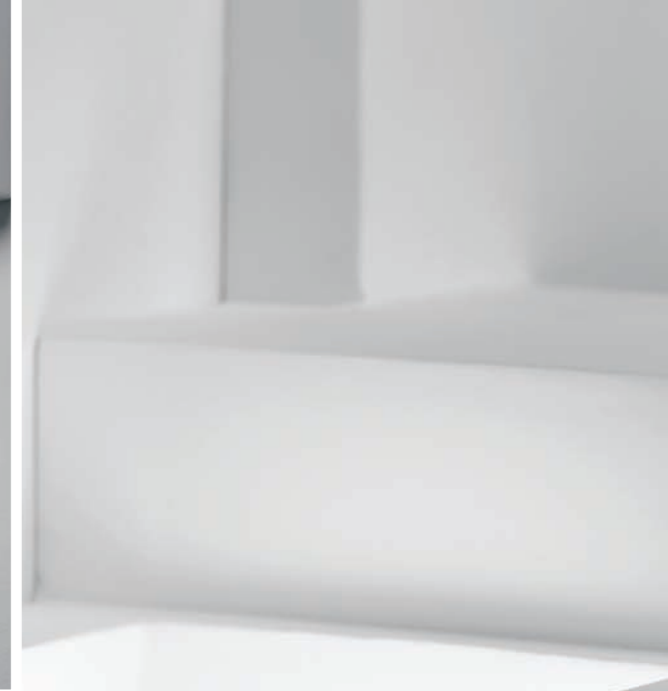
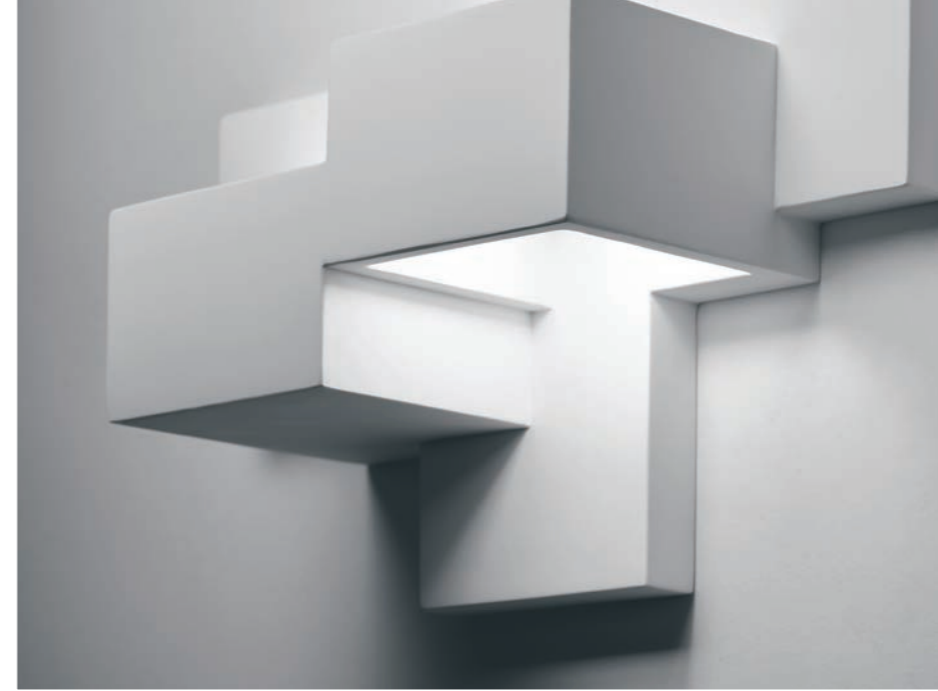
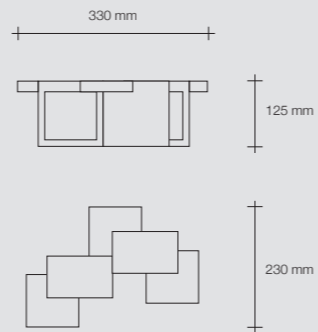

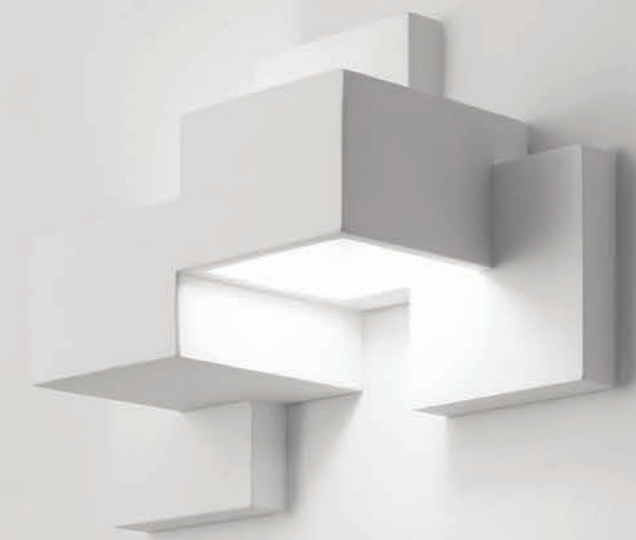

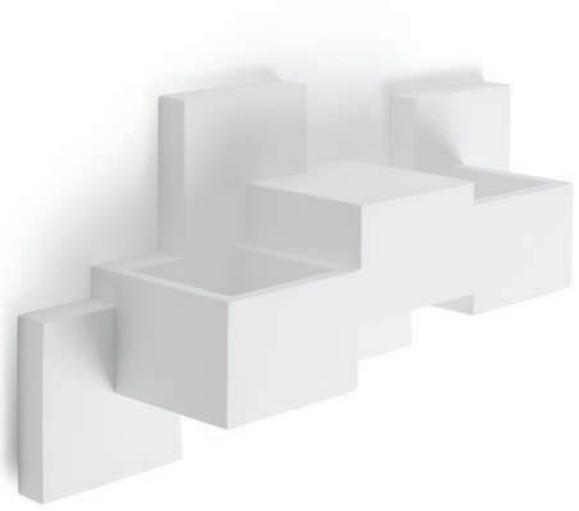

- Lampada da parete in gesso a tre luci biemissiva
- Per lampadine GX53
- Lampadine installabili: fluorescenti o led

- Plaster three-lights double-emission lamp
- Designed for GX53 bulbs
- Bulbs: fluorescent or LED

- Wandleuchte aus Gips mit zwei Leuchtmitteln, Bi-Emissions-Licht
- Für GX53 Leuchtmittel
- Installierbare Leuchtmittel: Leuchtstoff oder LED

- Luminaria para pared de yeso con tres luces, emisión doble
- Para lámparas GX53
- Lámparas que se pueden instalar: fluorescentes o de LED

- Двухнаправленный настенный гипсовый светильник с тремя лампочками
- Лампы с цоколем GX53
- Применяемые лампочки: флуоресцентные или светодиодные

Modello depositato

Registered design

Eingetragenes Mode

Modelo depositado

Зарегистрированная модель

Omologazioni

CE V A

Type-approvals

CE V A

Zulassungen

CE V A

Homologaciones

CE V A

Омологации

CE V A

T326



- GX53
- 3x10W

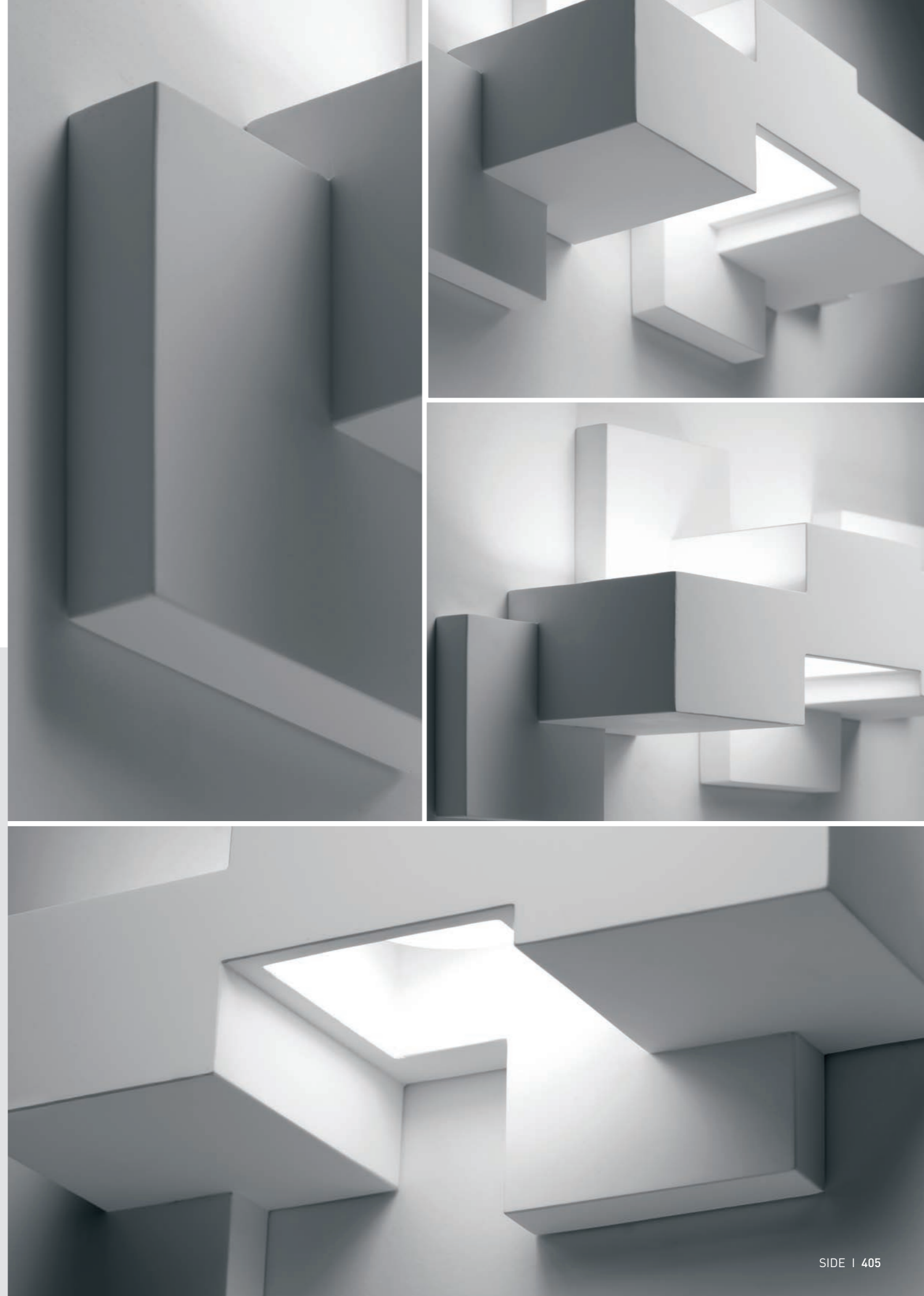
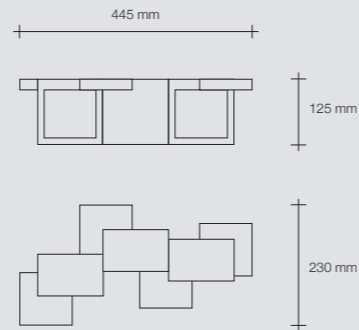





- Lampada a soffitto/parete in gesso a una luce
- Lampadine installabili: fluorescenti o led

- Plaster ceiling/wall lamp with one light
- Bulb type: fluorescent or LED

Modello depositato

Registered design

Omologazioni

CE V A

Type-approvals

CE V A

- Decken-/Wandleuchte aus Gips und mit einer Lampe
- Installierbare Lampen: Leuchtstoff oder LED

Eingetragenes Modell

Zulassungen

CE V A

- Lámpara de techo/pared de yeso con una luz
- Bombillas instalables: fluorescentes o led

Modelo depositado

Homologaciones

CE V A

- Гипсовый потолочный/настенный светильник с одной лампой
- Применяемые лампочки: флуоресцентные или светодиодные

Зарегистрированная модель

Омологации

CE V A

T294



- GX53
- 1x10W

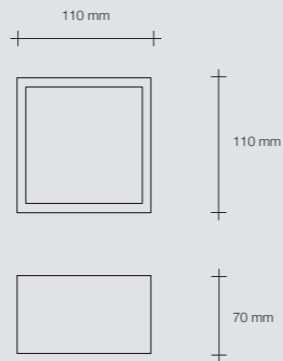



- Lampada a soffitto/parete in gesso a due luci
- Lampadine installabili: fluorescenti o led

- Plaster ceiling/wall lamp with two lights
- Bulb type: fluorescent or LED

- Decken-/Wandleuchte aus Gips und mit zwei Lampen
- Installierbare Lampen: Leuchtstoff oder LED

- Lámpara de techo/pared de yeso con dos luces
- Bombillas instalables: fluorescentes o led

- Гипсовый потолочный/настенный светильник с двумя лампами
- Применяемые лампочки: флуоресцентные или светодиодные

Modello depositato

Registered design

Eingetragenes Modell

Modelo depositado

Зарегистрированная модель

Omologazioni

Type-approvals

Zulassungen

Homologaciones

Омологации

CE V ⊕

CE V ⊕

CE V ⊕

CE V ⊕

CE V ⊕

T295



- GX53
- 2x10W

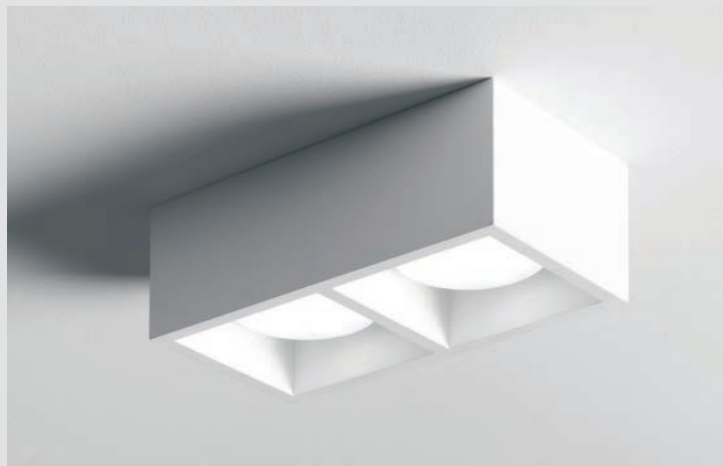
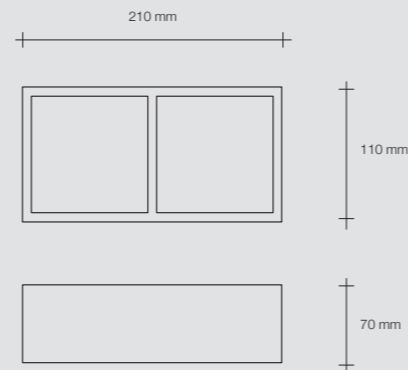



- Lampada a soffitto/parete in gesso a tre luci
- Lampadine installabili: fluorescenti o led

- Plaster ceiling lamp with three lights
- Bulb type: fluorescent or LED

- Deckenleuchte aus Gips mit drei Lampen
- Installierbare Lampen: Leuchtstoff oder LED

- Lámpara de techo de yeso con tres luces
- Bombillas instalables: fluorescentes o led

- Гипсовый потолочный светильник с тремя лампами
- Применяемые лампочки: флуоресцентные или светодиодные

Modello depositato

Registered design

Eingetragenes Modell

Modelo depositado

Зарегистрированная модель

Omologazioni

Type-approvals

Zulassungen

Homologaciones

Омологации

CEVⓈ

CEVⓈ

CEVⓈ

CEVⓈ

CEVⓈ

T296



- GX53
- 3x10W

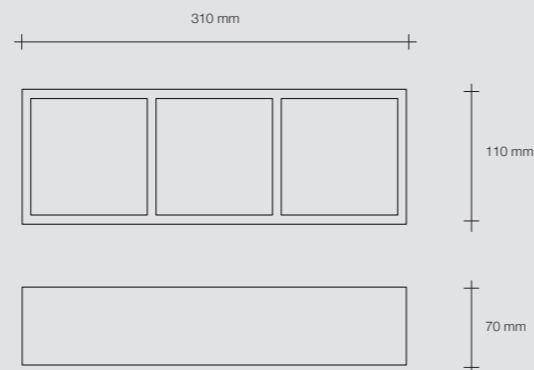



- Lampada da soffitto
in gesso a una luce
- Lampadine installabili:
fluorescenti o led

- Single-light plaster
ceiling light
- Compatible with
fluorescent or LED bulbs

- Deckenleuchte aus Gips
mit einer Lampe
- Installierbare Lampen:
Leuchtstoff oder LED

- Lámpara de techo de yeso
con una luz
- Bombillas instalables:
fluorescentes o Led

- Потолочный гипсовый светильник
с одной лампочкой
- Применяемые лампочки:
флуоресцентные или светодиодные

Modello depositato

Registered design

Eingetragenes Modell

Modelo depositado

Зарегистрированная модель

Omologazioni

CE V O

Type-approvals

CE V O

Zulassungen

CE V O

Homologaciones

CE V O

Омологации

CE V O

T312



- 1x10W
- Gx53

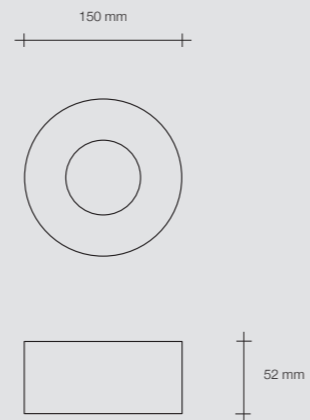



- Lampada da soffitto
in gesso a due luci
- Lampadine installabili:
fluorescenti o led

- 2-light plaster
ceiling light
- Compatible with
fluorescent or LED bulbs

- Deckenleuchte aus Gips
mit zwei Lampen
- Installierbare Lampen:
Leuchtstoff oder LED

- Lámpara de techo de yeso
con dos luces
- Bombillas instalables:
fluorescentes o Led

- Потолочный гипсовый светильник
с двумя лампочками
- Применяемые лампочки:
флуоресцентные или светодиодные

Modello depositato

Registered design

Eingetragenes Modell

Modelo depositado

Зарегистрированная модель

Omologazioni

CE V A

Type-approvals

CE V A

Zulassungen

CE V A

Homologaciones

CE V A

Омологации

CE V A

T313



- 2x10W
- Gx53

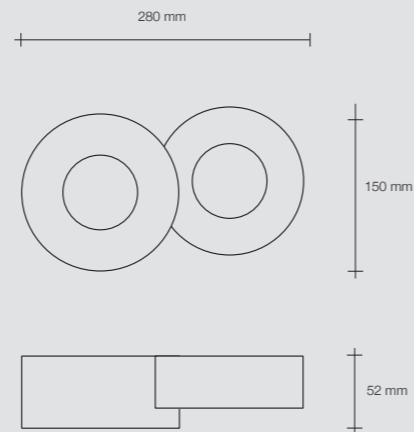



- Lampada da soffitto
in gesso a tre luci
- Lampadine installabili:
fluorescenti o led

- 3-light plaster
ceiling light
- Compatible with
fluorescent or LED bulbs

- Deckenleuchte aus Gips
mit drei Lampen
- Installierbare Lampen:
Leuchtstoff oder LED

- Lámpara de techo de yeso
con tres luces
- Bombillas instalables:
fluorescentes o Led

- Потолочный гипсовый светильник
с тремя лампочками
- Применяемые лампочки:
флуоресцентные или светодиодные

Modello depositato

Registered design

Eingetragenes Modell

Modelo depositado

Зарегистрированная модель

Omologazioni

CE V ⊕

Type-approvals

CE V ⊕

Zulassungen

CE V ⊕

Homologaciones

CE V ⊕

Омологации

CE V ⊕

T314



- 3x10W
- Gx53

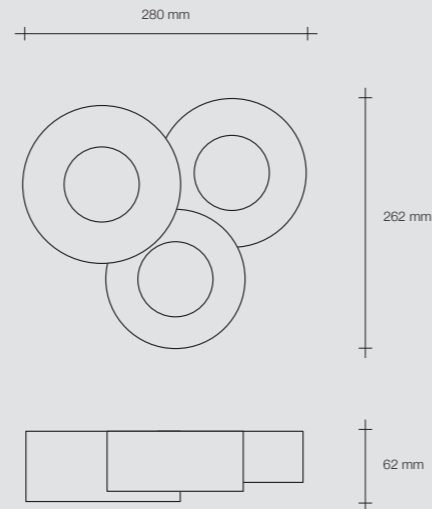



- Lampada da soffitto
in gesso a una luce
- Lampadine installabili:
fluorescenti o led

- Single-light plaster
ceiling light
- Compatible with
fluorescent or LED bulbs

- Deckenleuchte aus Gips
mit einer Lampe
- Installierbare Lampen:
Leuchtstoff oder LED

- Lámpara de techo de yeso
con una luz
- Bombillas instalables:
fluorescentes o Led

- Потолочный гипсовый светильник
с одной лампочкой
- Применяемые лампочки:
флуоресцентные или светодиодные

Modello depositato

Registered design

Eingetragenes Modell

Modelo depositado

Зарегистрированная модель

Omologazioni

Type-approvals

Zulassungen

Homologaciones

Омологации

CEV

CEV

CEV

CEV

CEV

T267



- GX53
- 1x10W

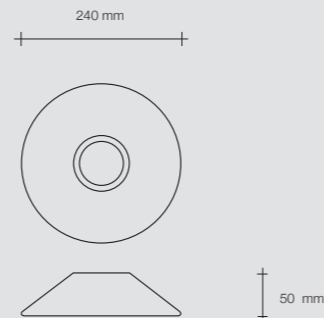



- Lampada da soffitto
in gesso a due luci
- Lampadine installabili:
fluorescenti o led

- 2-light plaster
ceiling light
- Compatible with
fluorescent or LED bulbs

- Deckenleuchte aus Gips
mit zwei Lampen
- Installierbare Lampen:
Leuchtstoff oder LED

- Lámpara de techo de yeso
con dos luces
- Bombillas instalables:
fluorescentes o Led

- Потолочный гипсовый светильник
с двумя лампочками
- Применяемые лампочки:
флуоресцентные или светодиодные

Modello depositato

Registered design

Eingetragenes Modell

Modelo depositado

Зарегистрированная модель

Omologazioni

CE V

Type-approvals

CE V

Zulassungen

CE V

Homologaciones

CE V

Омологации

CE V

T268



- GX53
- 2x10W

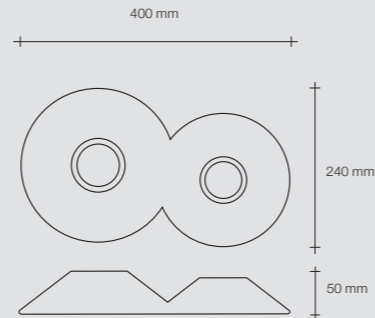



- Lampada da soffitto
in gesso a tre luci
- Lampadine installabili:
fluorescenti o led

- 3-light plaster
ceiling light
- Compatible with
fluorescent or LED bulbs

- Deckenleuchte aus Gips
mit drei Lampen
- Installierbare Lampen:
Leuchtstoff oder LED

- Lámpara de techo de yeso
con tres luces
- Bombillas instalables:
fluorescentes o Led

- Потолочный гипсовый светильник
с тремя лампочками
- Применяемые лампочки:
флуоресцентные или светодиодные

Modello depositato

Registered design

Eingetragenes Modell

Modelo depositado

Зарегистрированная модель

Omologazioni

CE V A

Type-approvals

CE V A

Zulassungen

CE V A

Homologaciones

CE V A

Омологации

CE V A

T287



- GX53
-3x10W

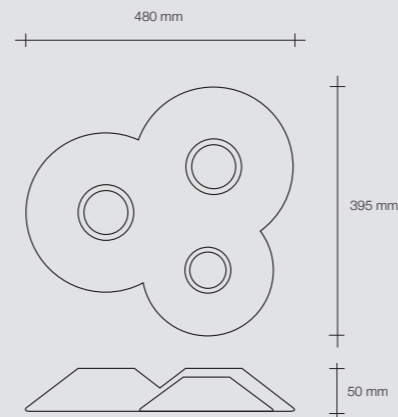



- Lampada da soffitto
in gesso a quattro luci
- Lampadine installabili:
fluorescenti o led

- 4-light plaster
ceiling light
- Compatible with
fluorescent or LED bulbs

- Deckenleuchte aus Gips
mit vier Lampen
- Installierbare Lampen:
Leuchtstoff oder LED

- Lámpara de techo de yeso
con cuatro luces
- Bombillas instalables:
fluorescentes o Led

- Потолочный гипсовый светильник
с четырьмя лампочками
- Применяемые лампочки:
флуоресцентные или светодиодные

Modello depositato

Registered design

Eingetragenes Modell

Modelo depositado

Зарегистрированная модель

Omologazioni

CE V ⊕

Type-approvals

CE V ⊕

Zulassungen

CE V ⊕

Homologaciones

CE V ⊕

Омологации

CE V ⊕

T303



- GX53
- 4x10W

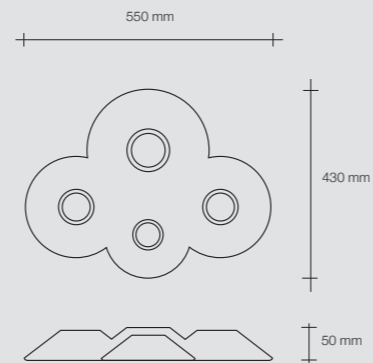

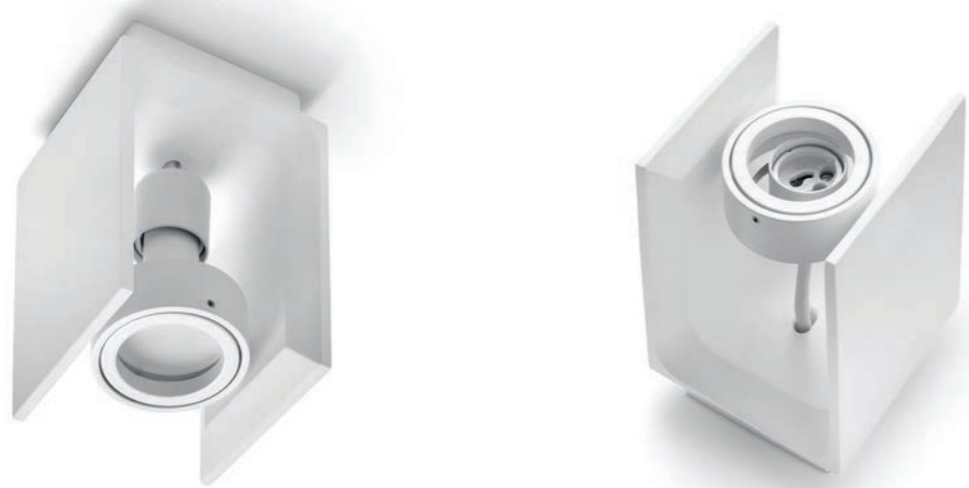

- Lampada a soffitto in gesso ad una luce con sorgente luminosa orientabile
- Lampadine installabili: alogene, fluorescenti o led

- Single-light plaster ceiling light with directional light source
- Compatible with halogen, fluorescent or LED bulbs

- Deckenleuchte aus Gips mit einer Lampe und ausrichtbarer Lichtquelle
- Installierbare Lampen: Halogen, Leuchtstoff oder LED

- Lámpara de techo de yeso con una luz con fuente luminosa orientable
- Bombillas instalables: halógenas, fluorescentes o led

- Гипсовый потолочный светильник с одной лампочкой и ориентируемым источником света.
- Применяемые лампочки: галогенные, флуоресцентные или светодиодные

Modello depositato

Registered design

Eingetragenes Modell

Modelo depositado

Зарегистрированная модель

Omologazioni

CE V A

Type-approvals

CE V A

Zulassungen

CE V A

Homologaciones

CE V A

Омологации

CE V A

T258



- GU10
- 1x40W

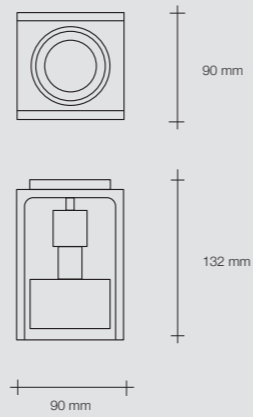

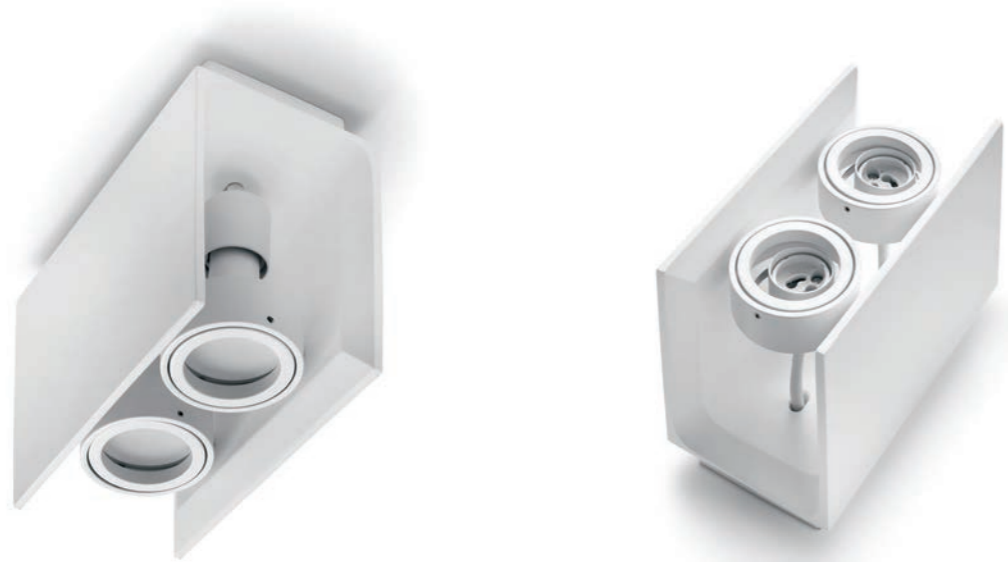

- Lampada a soffitto in gesso a due luci con sorgente luminosa orientabile
- Lampadine installabili: alogene, fluorescenti o led

- 2 light plaster ceiling light with directional light source
- Compatible with halogen, fluorescent or LED bulbs

- Deckenleuchte aus Gips mit zwei Lampen und ausrichtbarer Lichtquelle
- Installierbare Lampen: Halogen, Leuchtstoff oder LED

- Lámpara de techo de yeso con dos luces con fuente luminosa orientable
- Bombillas instalables: halógenas, fluorescentes o led

- Гипсовый потолочный светильник с двумя лампочками и ориентируемым источником света.
- Применяемые лампочки: галогенные, флуоресцентные или светодиодные

Modello depositato

Registered design

Eingetragenes Modell

Modelo depositado

Зарегистрированная модель

Omologazioni

CE V A

Type-approvals

CE V A

Zulassungen

CE V A

Homologaciones

CE V A

Омологации

CE V A

T259



- GU10
- 2x40W

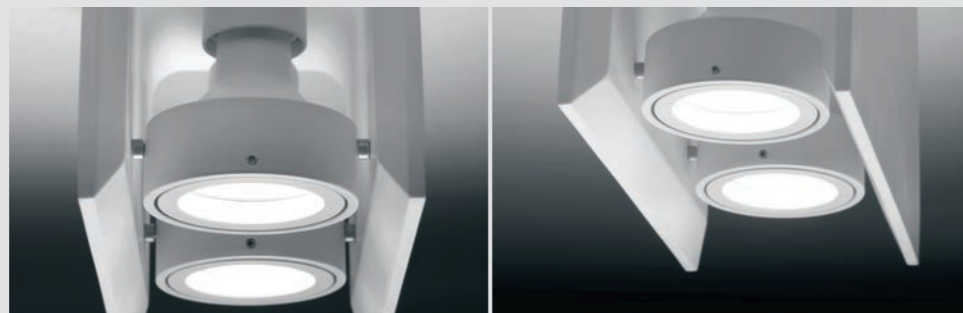
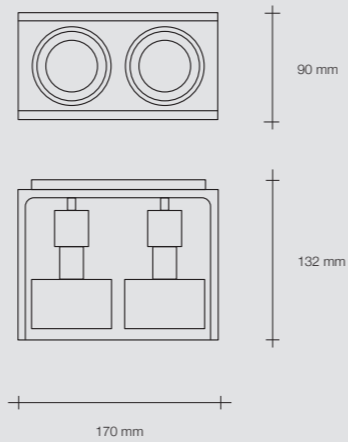

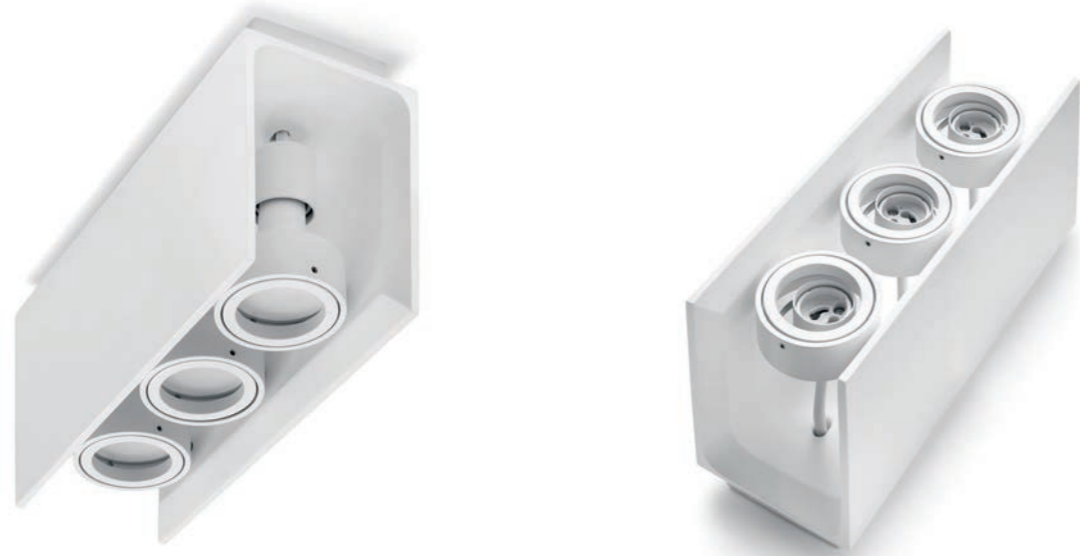

- Lampada a soffitto in gesso a tre luci con sorgente luminosa orientabile
- Lampadine installabili: alogene, fluorescenti o led

- 3 light plaster ceiling light with directional light source
- Compatible with halogen, fluorescent or LED bulbs

- Deckenleuchte aus Gips mit drei Lampen und ausrichtbarer Lichtquelle
- Installierbare Lampen: Halogen, Leuchtstoff oder LED

- Lámpara de techo de yeso con tres luces con fuente luminosa orientable
- Bombillas instalables: halógenas, fluorescentes o led

- Гипсовый потолочный светильник с тремя лампочками и ориентируемым источником света.
- Применяемые лампочки: галогенные, флуоресцентные или светодиодные

Modello depositato

Registered design

Eingetragenes Modell

Modelo depositado

Зарегистрированная модель

Omologazioni

Type-approvals

Zulassungen

Homologaciones

Омологации

CE V A

CE V A

CE V A

CE V A

CE V A

T260



- GU10
- 3x40W

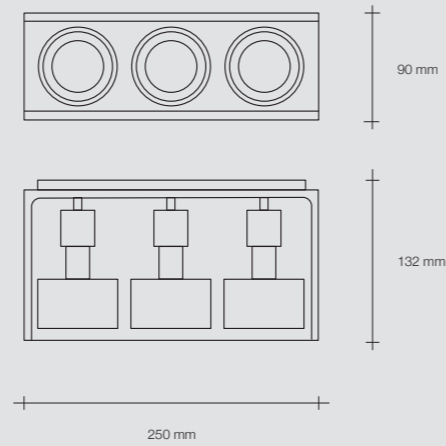

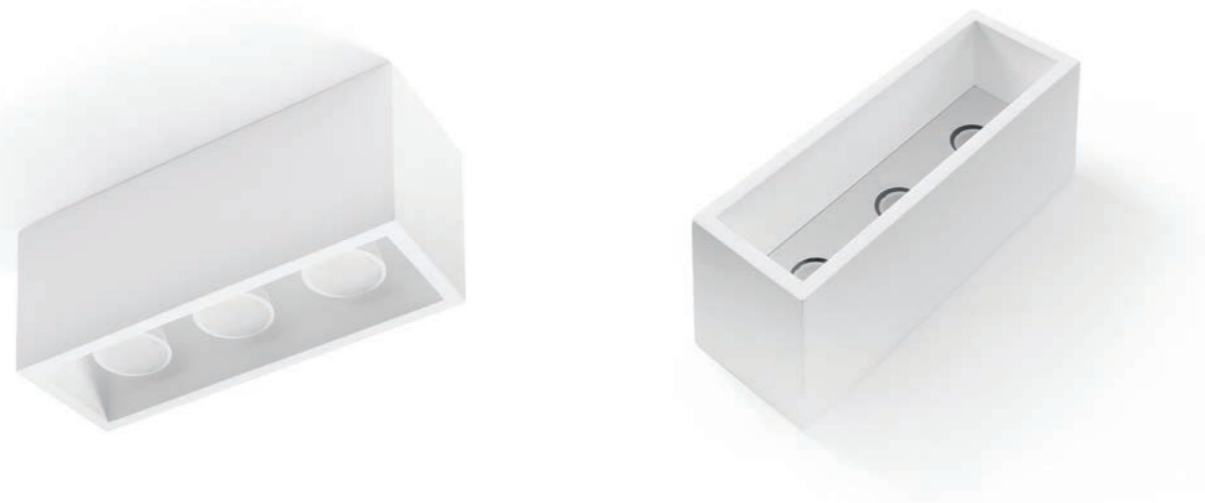

- Lampada a soffitto in gesso a tre luci
- Lampadine installabili: alogene, fluorescenti o led

- 3 light plaster ceiling light
- Compatible with halogen, fluorescent or LED bulbs

- Deckenleuchte aus Gips mit drei Lampen
- Installierbare Lampen: Halogen, Leuchtstoff oder LED

- Lámpara de techo de yeso con tres luces
- Bombillas instalables: halógenas, fluorescentes o led

- Гипсовый потолочный светильник с тремя лампочками.
- Применяемые лампочки: галогенные, флуоресцентные или светодиодные

Modello depositato

Registered design

Eingetragenes Modell

Modelo depositado

Зарегистрированная модель

Omologazioni

Type-approvals

Zulassungen

Homologaciones

Омологации

CE V

CE V

CE V

CE V

CE V

T271



- GU10
- 3x40W

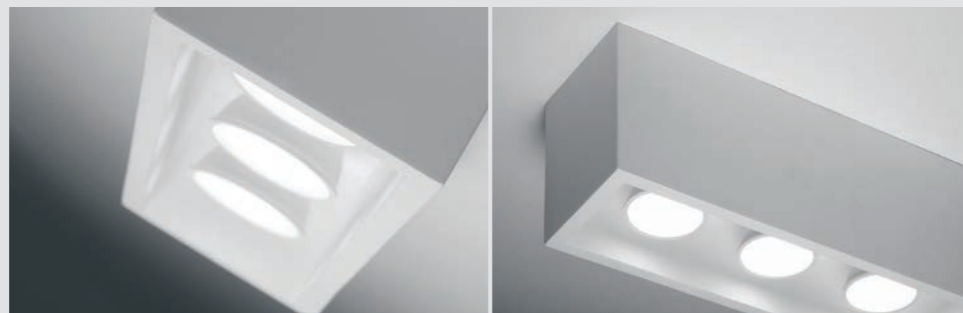
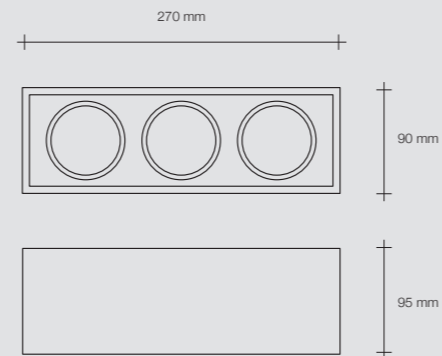

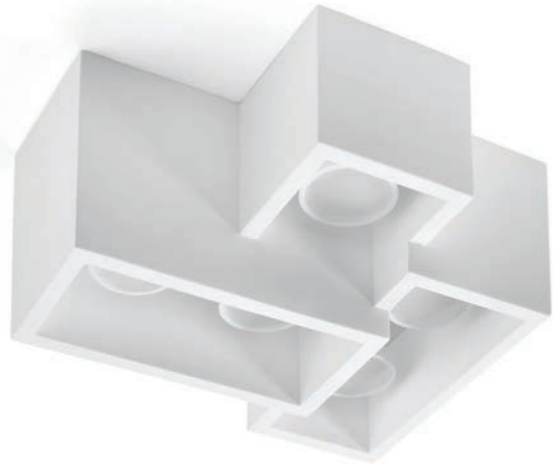

- Lampada a soffitto in gesso a cinque luci
- Lampadine installabili: alogene, fluorescenti o led

- 5 light plaster ceiling light
- Compatible with halogen, fluorescent or LED bulbs

- Deckenleuchte aus Gips mit fünf Lampen
- Installierbare Lampen: Halogen, Leuchtstoff oder LED

- Lámpara de techo de yeso con cinco luces
- Bombillas instalables: halógenas, fluorescentes o led

- Гипсовый потолочный светильник с пятью лампочками.
- Применяемые лампочки: галогенные, флуоресцентные или светодиодные

Modello depositato

Registered design

Eingetragenes Modell

Modelo depositado

Зарегистрированная модель

Omologazioni

Type-approvals

Zulassungen

Homologaciones

Омологации

CE V O

CE V O

CE V O

CE V O

CE V O

T273



- GU10
- 5x40W

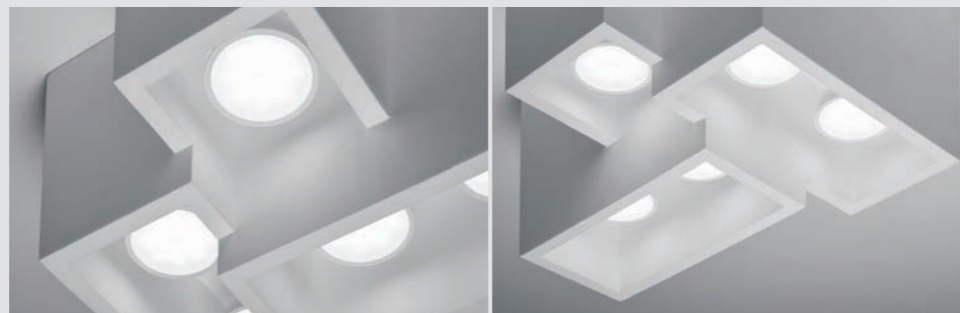
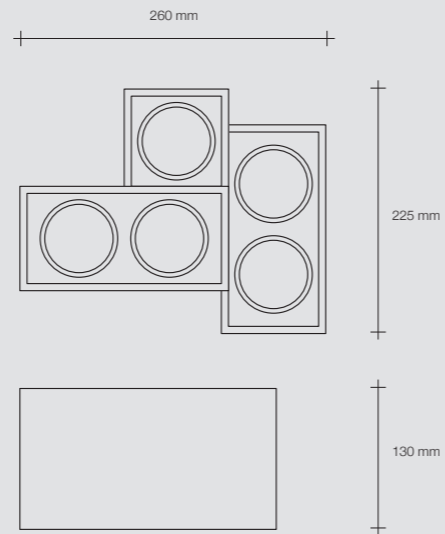

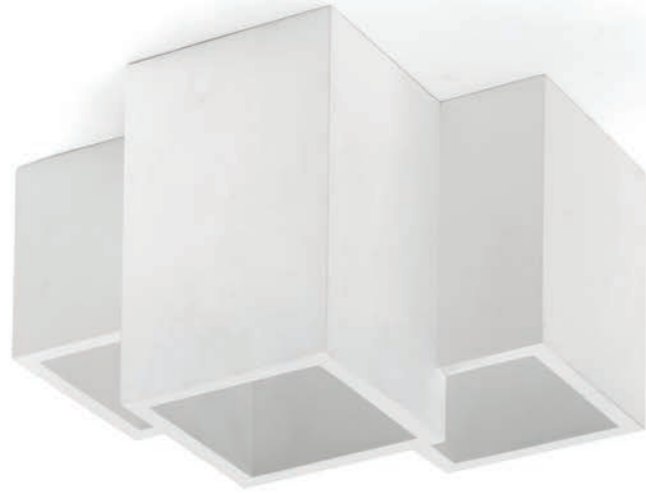

- Lampada a soffitto.
- Lampadina installabile alogena, fluorescente o led con attacco GU10.

- Ceiling lamp.
- Takes a halogen, fluorescent or LED light bulb with GU10 connection.

- Deckenleuchte.
- Installierbare Halogenlampe, Leuchtstofflampe oder LED mit GU10 Fassung.

- Lámpara de techo.
- Bombilla instalable halógena, fluorescente o LED con casquillo GU10.

- Потолочный светильник.
- Применяемые лампочки: галогенная, флуоресцентная или светодиодная с цоколем GU10.

Omologazioni
CE V

Type-approvals
CE V

Zulassungen
CE V

Homologaciones
CE V

Омологации
CE V

T193



- GU10
- 3x40W

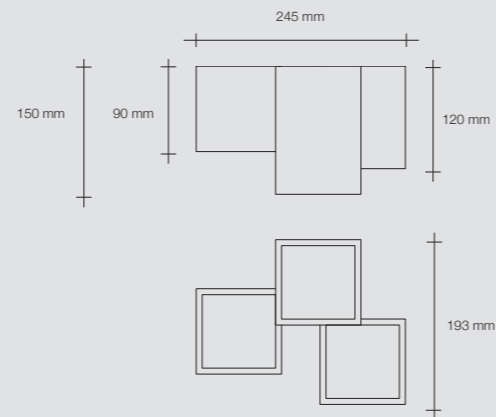

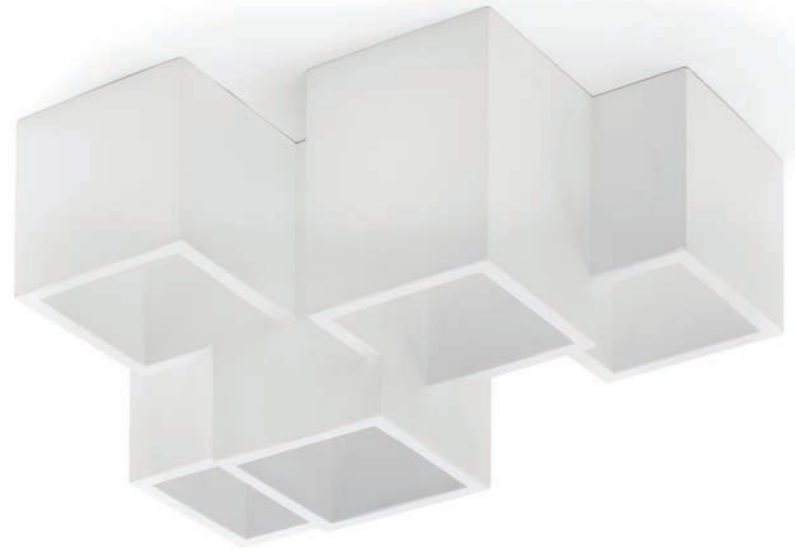

- Lampada a soffitto.
- Lampadina installabile alogena, fluorescente o led con attacco GU10.

- Ceiling lamp.
- Takes a halogen, fluorescent or LED light bulb with GU10 connection.

- Deckenleuchte.
- Installierbare Halogenlampe, Leuchtstofflampe oder LED mit GU10 Fassung.

- Lámpara de techo.
- Bombilla instalable halógena, fluorescente o LED con casquillo GU10.

- Потолочный светильник.
- Применяемые лампочки: галогенная, флуоресцентная или светодиодная с цоколем GU10.

Omologazioni
CE V

Type-approvals
CE V

Zulassungen
CE V

Homologaciones
CE V

Омологации
CE V

T194



- GU10
- 5x40W

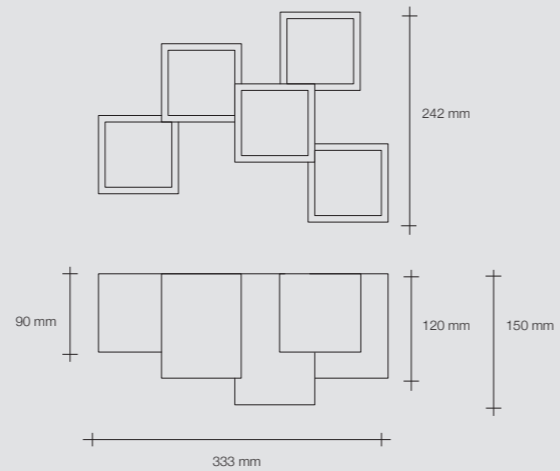



- Lampada da parete gesso biemissione.
- Lampadina installabile alogena, fluorescente o led con attacco G9.

- Plaster, dual emission wall light.
- Takes a halogen, fluorescent or LED light bulb with G9 connection.

- Wandleuchte aus Gips Biemission.
- Installierbare Halogenlampe, Leuchtstofflampe oder LED mit G9 Fassung.

- Aplique para pared de yeso con doble emisión.
- Bombilla instalable halógena, fluorescente o LED con casquillo G9.

- Двухнаправленный настенный светильник из гипса.
- Применяемые лампочки: галогенная, флуоресцентная или светодиодная с цоколем G9.

Omologazioni
CE V

Type-approvals
CE V

Zulassungen
CE V

Homologaciones
CE V

Омологации
CE V

T205



- 4x40W
- G9

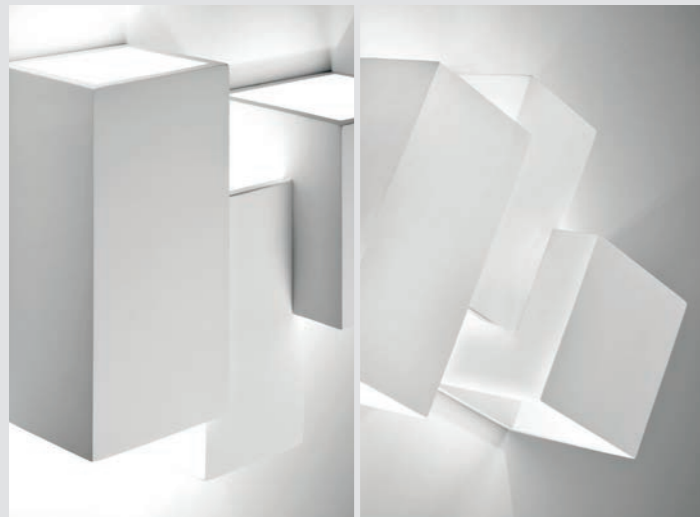
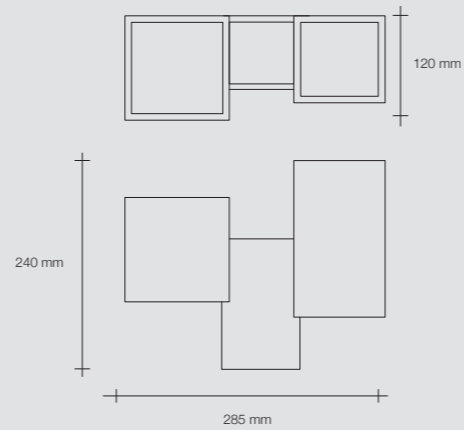

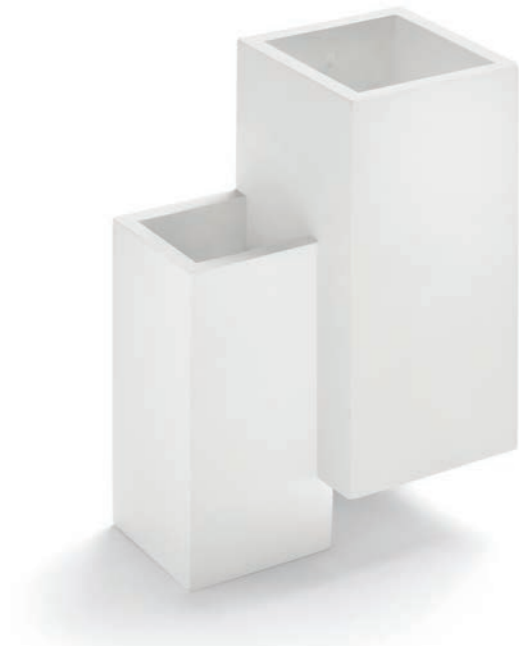

- Lampada da parete gesso biemissione.
- Lampadina installabile alogena, fluorescente o led con attacco G9.

- Plaster, dual emission wall light.
- Takes a halogen, fluorescent or LED light bulb with G9 connection.

- Wandleuchte aus Gips Biemission.
- Installierbare Halogenlampe, Leuchtstofflampe oder LED mit G9 Fassung.

- Aplique para pared de yeso con doble emisión.
- Bombilla instalable halógena, fluorescente o LED con casquillo G9.

- Двухнаправленный настенный светильник из гипса.
- Применяемые лампочки: галогенная, флуоресцентная или светодиодная с цоколем G9.

Omologazioni
CE V ⊕

Type-approvals
CE V ⊕

Zulassungen
CE V ⊕

Homologaciones
CE V ⊕

Омологации
CE V ⊕

T206



- 3x40W
- G9

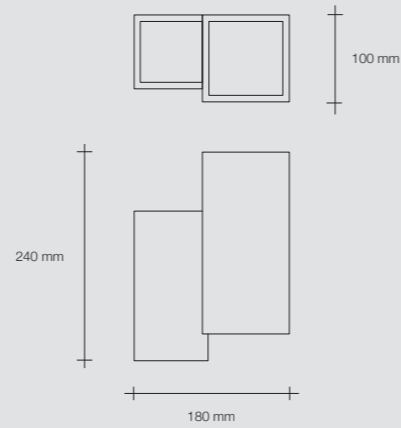



Lampada da parete gesso biemissione.
Moduli led e alimentatori integrati.

Plaster, dual emission wall lamp.
Integrated LED modules and power supply units.

Wandleuchte aus Gips mit Bi-Emissions-Licht.
LED Module und Netzteile integriert

Aplique para pared de yeso con doble emisión.
Módulos LED y fuentes de alimentación incorporados.

Двунаправленный настенный светильник из гипса.
Интегрированные светодиодные модули и блоки питания.

Omologazioni
CE V

Type-approvals
CE V

Zulassungen
CE V

Homologaciones
CE V

Омологации
CE V

T207



- 2x3W
- 3000°K
- 540 lumen

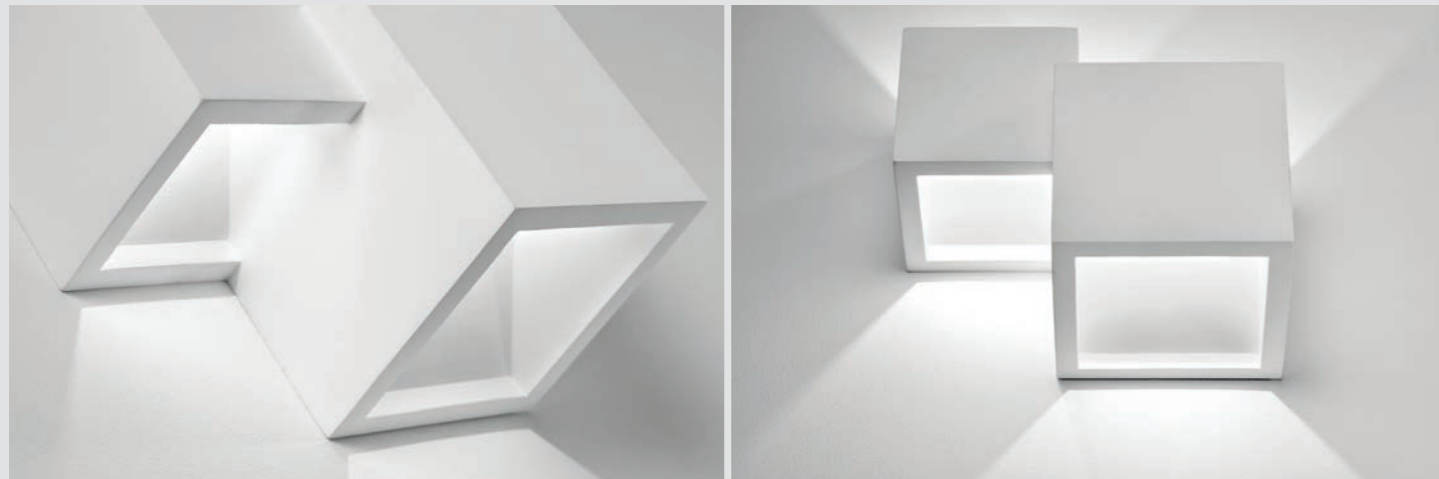
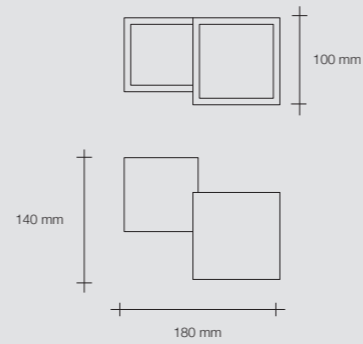

ESIODO MICRO



- Lampada da soffitto in gesso
- Lampadina installabile alogena, fluorescente o led con attacco GU10.

- Plaster ceiling light
- Takes a halogen, fluorescent or LED light bulb with GU10 connection.

- Deckenlampe aus Gips
- Installierbar sind Halogenlampe, Leuchtstofflampe oder Led mit Anschluss GU10.

- Lámpara para techo de yeso
- Acepta bombillas halógenas, fluorescentes o de LED con casquillo GU10.

- Потолочный светильник из гипса
- Можно устанавливать галогенные, флуоресцентные и светодиодные лампочки с цоколем GU10.

Omologazioni

CE V ⊕

Type-approvals

CE V ⊕

Zulassungen

CE V ⊕

Homologaciones

CE V ⊕

Омологации

CE V ⊕

T179



- GU10
- 1x40W

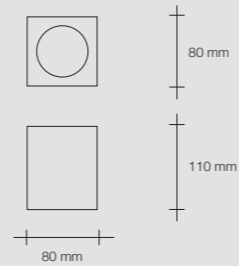

Esempio di prodotto verniciato
Example of painted product
Beispiel für das gestrichene Produkt
Ejemplo de producto pintado
Пример покрашенного прибора





- Lampada da parete gesso biemissione.
- Lampadina installabile alogena, fluorescente o led con attacco G9.

- Plaster, dual emission wall light.
- Takes a halogen, fluorescent or LED light bulb with G9 connection.

- Wandleuchte aus Gips Biemission.
- Installierbare Halogenlampe, Leuchtstofflampe oder LED mit G9 Fassung.

- Aplique para pared de yeso con doble emisión.
- Bombillas instalbles halógenas, fluorescentes o LED con casquillo G9.

- Двухнаправленный настенный светильник из гипса.
- Применяемые лампочки: галогенная, флуоресцентная или светодиодная с цоколем G9.

Omologazioni

CE V

Type-approvals

CE V

Zulassungen

CE V

Homologaciones

CE V

Омологации

CE V

T203



- 1x40W
- G9

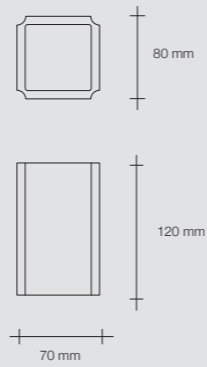



- Lampada a soffitto in gesso a tre luci
- Per lampadine GU10
- Lampadine installabili: alogene, fluorescenti o led

- 3 light plaster ceiling light
- Designed for GU10 bulbs
- Compatible with halogen, fluorescent or LED bulbs

- Deckenleuchte aus Gips mit drei Lampen
- Für Lampen mit GU10 Fassung
- Installierbare Lampen: Halogen, Leuchtstoff oder LED

- Lámpara de techo de yeso con tres luces
- Para bombillas GU10
- Bombillas instalables: halógenas, fluorescentes o led

- Гипсовый потолочный светильник с тремя лампочками.
- Подходящие лампочки – с цоколем GU10.
- Применяемые лампочки: галогенные, флуоресцентные или светодиодные

Modello depositato

Registered design

Eingetragenes Modell

Modelo depositado

Зарегистрированная модель

Omologazioni



Type-approvals



Zulassungen



Homologaciones



Омологации



T265



- GU10
- 3x40W

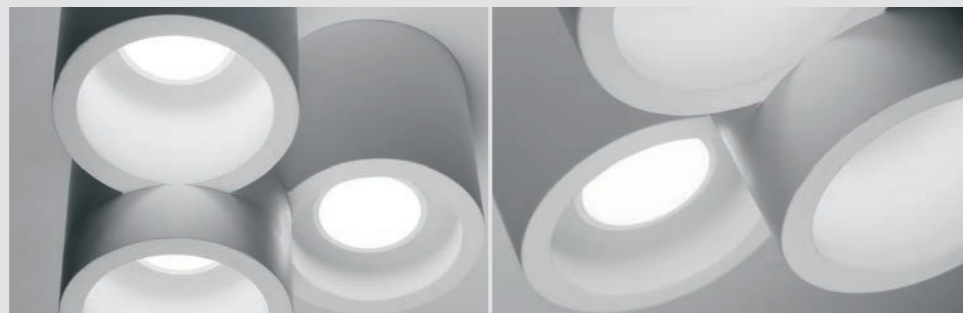
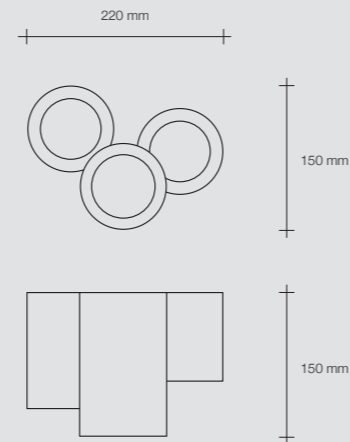



- Lampada a soffitto in gesso a cinque luci
- Per lampadine GU10
- Lampadine installabili: alogene, fluorescenti o led

- 5 light plaster ceiling light
- Designed for GU10 bulbs
- Compatible with halogen, fluorescent or LED bulbs

- Deckenleuchte aus Gips mit fünf Lampen
- Für Lampen mit GU10 Fassung
- Installierbare Lampen: Halogen, Leuchtstoff oder LED

- Lámpara de techo de yeso con cinco luces
- Para bombillas GU10
- Bombillas instalables: halógenas, fluorescentes o led

- Гипсовый потолочный светильник с пятью лампочками.
- Подходящие лампочки – с цоколем GU10
- Применяемые лампочки: галогенные, флуоресцентные или светодиодные

Modello depositato

Registered design

Eingetragenes Modell

Modelo depositado

Зарегистрированная модель

Omologazioni

CE V A

Type-approvals

CE V A

Zulassungen

CE V A

Homologaciones

CE V A

Омологации

CE V A

T266



- GU10
- 5x40W

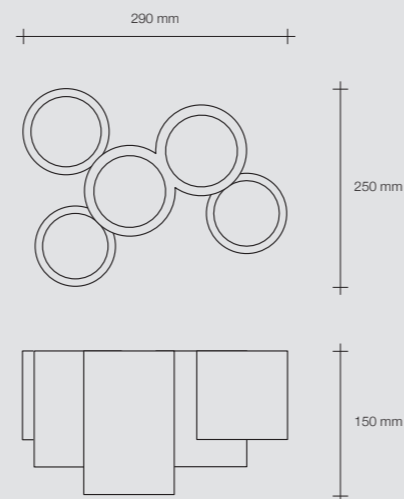



Lampada a parete in gesso biemissione.
Risulta parte integrante della parete e può essere tinteggiata.
Lampadina installabile alogena, fluorescente o led con attacco G9.

Plaster, dual emission wall lamp. It becomes an integral part of the wall and can be painted.
Takes a halogen, fluorescent or LED light bulb with G9 connection.

Wandleuchte aus Gips mit Bi-Emissions-Licht.
Wird eins mit der Wand und kann gestrichen werden.
Installierbare Halogenlampe, Leuchtstofflampe oder LED mit G9 Fassung.

Aplique para pared de yeso con doble emisión.
Forma parte integrante de la pared y se puede pintar.
Bombilla instalable halógena, fluorescente o LED con casquillo G9.

Двунаправленный настенный светильник из гипса.
Установленный светильник будет неотъемлемой частью стены и можно будет его покрасить.
Применяемые лампочки: галогенная, флуоресцентная или светодиодная с цоколем G9.

Omologazioni
CE V

Type-approvals
CE V

Zulassungen
CE V

Homologaciones
CE V

Омологации
CE V

T253



- 3x40W
- G9

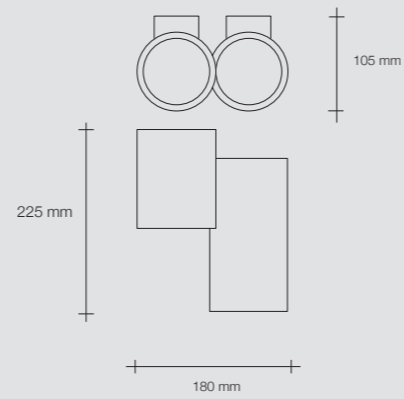



Lampada a parete in gesso biemissione.
Risulta parte integrante della parete e può essere tinteggiata.
Lampadina installabile alogena, fluorescente o led con attacco G9.

Plaster, dual emission wall lamp. It becomes an integral part of the wall and can be painted.
Takes a halogen, fluorescent or LED light bulb with G9 connection.

Wandleuchte aus Gips mit Bi-Emissions-Licht.
Wird eins mit der Wand und kann gestrichen werden.
Installierbare Halogenlampe, Leuchtstofflampe oder LED mit G9 Fassung.

Aplique para pared de yeso con doble emisión.
Forma parte integrante de la pared y se puede pintar.
Bombilla instalable halógena, fluorescente o LED con casquillo G9.

Двунаправленный настенный светильник из гипса.
Установленный светильник будет неотъемлемой частью стены и можно будет его покрасить.
Применяемые лампочки галогенная, флуоресцентная или светодиодная с цоколем G9.

Omologazioni
CE V □

Type-approvals
CE V □

Zulassungen
CE V □

Homologaciones
CE V □

Омологации
CE V □

T254



- 6x40W
- G9

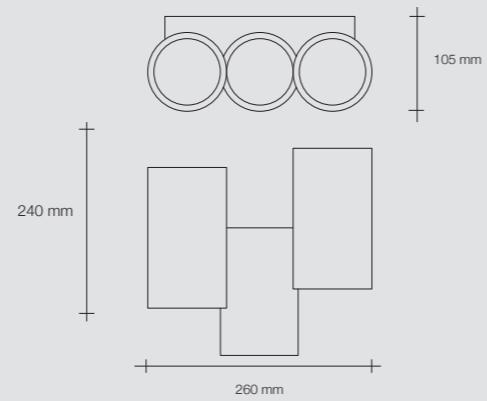

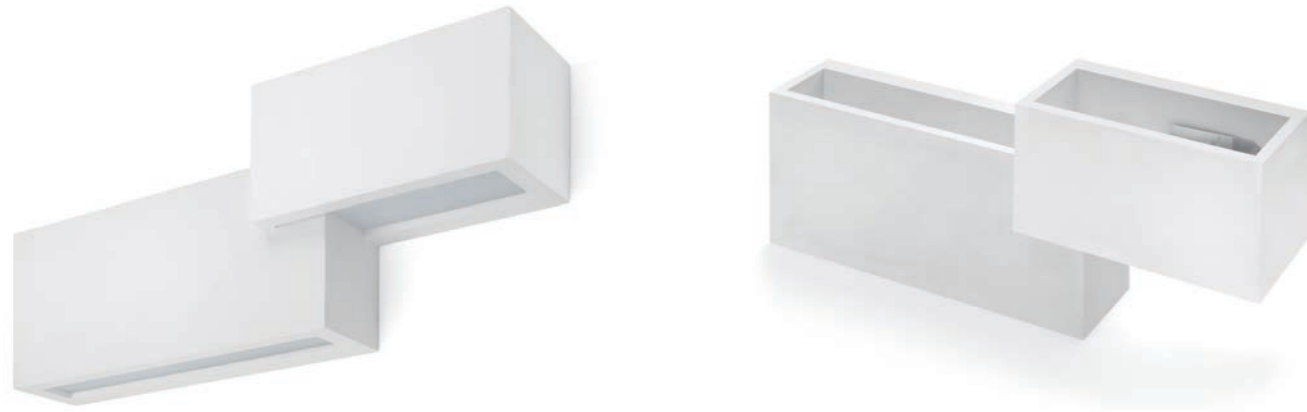

- Lampada a parete in gesso a 3 luci con doppia emissione per illuminazione diretta e indiretta
- Lampadine installabili: alogene, fluorescenti o led

- Plaster wall lamp with 3 lights with double emission for direct and indirect lighting
- Bulb type: halogen, fluorescent or LED

- Wandleuchte aus Gips mit 3 Lampen und doppelter Lichtabgabe zur direkten und indirekten Beleuchtung
- Installierbare Lampen: Halogen, Leuchtstoff oder LED

- Aplique para pared de yeso con 3 luces con doble emisión para iluminación directa e indirecta
- Bombillas instalables: halógenas, fluorescentes o led

- Двухнаправленный гипсовый потолочный светильник с тремя лампами, подходящий для прямого и непрямого освещения
- Применяемые лампочки: галогенные, флуоресцентные или светодиодные

Modello depositato

Registered design

Eingetragenes Modell

Modelo depositado

Зарегистрированная модель

Omologazioni

CE V ⊕

Type-approvals

CE V ⊕

Zulassungen

CE V ⊕

Homologaciones

CE V ⊕

Омологации

CE V ⊕

T269



- 5x40W
- G9

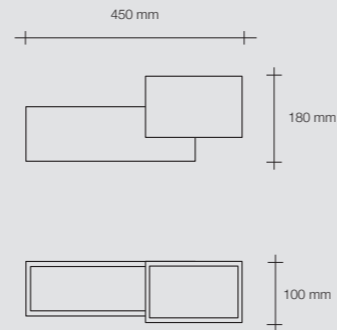

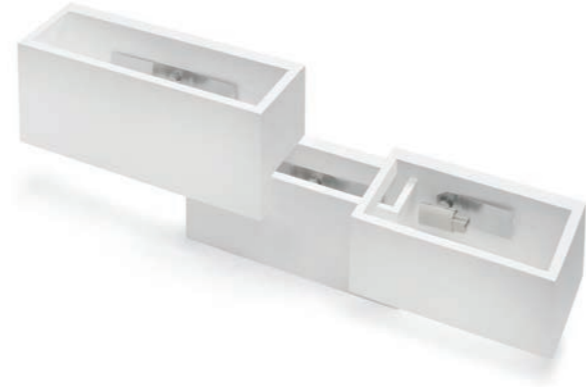
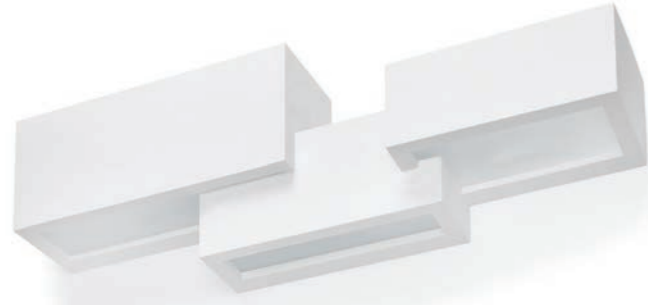

- Lampada a parete in gesso a 5 luci con doppia emissione per illuminazione diretta e indiretta
- Lampadine installabili: alogene, fluorescenti o led

- Plaster wall lamp with 5 lights with double emission for direct and indirect lighting
- Bulb type: halogen, fluorescent or LED

- Wandleuchte aus Gips mit 5 Lampen und doppelter Lichtabgabe zur direkten und indirekten Beleuchtung
- Installierbare Lampen: Halogen, Leuchtstoff oder LED

- Aplique para pared de yeso con 5 luces con doble emisión para iluminación directa e indirecta
- Bombillas instalables: halógenas, fluorescentes o led

- Двухнаправленный гипсовый потолочный светильник с пятью лампами, подходящий для прямого и непрямого освещения
- Применяемые лампочки: галогенные, флуоресцентные или светодиодные

Modello depositato

Registered design

Eingetragenes Modell

Modelo depositado

Зарегистрированная модель

Omologazioni

CE V A

Type-approvals

CE V A

Zulassungen

CE V A

Homologaciones

CE V A

Омологации

CE V A

T270



- 5 x 40 W
- G9

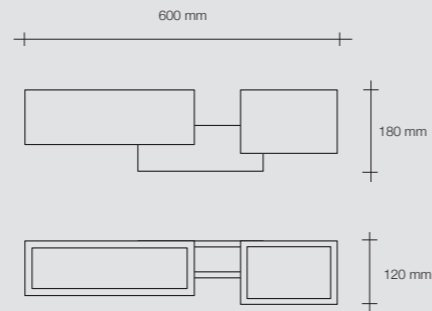

DELFI

DESIGN: LUCA ARTIOLI





Lampada da parete gesso. Biemissione, forma curvata sul lato, con effetto di movimento. Lampadina installabile alogena, fluorescente o led.

Plaster wall light. Dual emission, curved shape on one side, giving the effect of movement. Takes a halogen, fluorescent or LED light bulb.

Wandleuchte aus Gips. Bi-Emissions-Licht, gebogene Form an der Seite, mit Bewegungseffekt. Halogenlampe, Leuchtstofflampe oder LED installierbar.

Aplicque para pared de yeso. Doble emisión, forma curva en el lado, con efecto de movimiento. Bombilla instalable halógena, fluorescente o LED.

Настенный светильник из гипса. Двухнаправленный светильник с закругленной сбоку формой и эффектом движения. Применяемые лампочки: галогенная, флуоресцентная или светодиодная.

Omologazioni
CE V

Type-approvals
CE V

Zulassungen
CE V

Homologaciones
CE V

Омологации
CE V



Lampada da parete gesso. Biemissione, forma curvata sul lato, con effetto di movimento. Lampadina installabile alogena, fluorescente o led.

Plaster wall light. Dual emission, curved shape on one side, giving the effect of movement. Takes a halogen, fluorescent or LED light bulb.

Wandleuchte aus Gips. Bi-Emissions-Licht, gebogene Form an der Seite, mit Bewegungseffekt. Halogenlampe, Leuchtstofflampe oder LED installierbar.

Aplicque para pared de yeso. Doble emisión, forma curva en el lado, con efecto de movimiento. Bombilla instalable halógena, fluorescente o LED.

Настенный светильник из гипса. Двухнаправленный светильник с закругленной сбоку формой и эффектом движения. Применяемые лампочки: галогенная, флуоресцентная или светодиодная.

Omologazioni
CE V

Type-approvals
CE V

Zulassungen
CE V

Homologaciones
CE V

Омологации
CE V

T222



- 1x35W
- G9

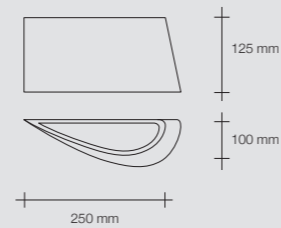

T223



- 2x35W
- G9

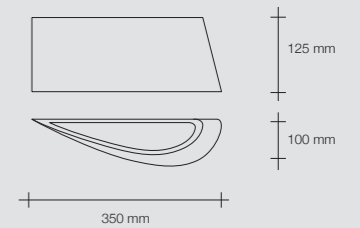

Esempio di prodotto verniciato
Example of painted product
Beispiel für das gestrichene Produkt
Ejemplo de producto pintado
Пример окрашенного прибора





Lampada da parete gesso.
Biemissione, forma curvata sul lato,
con effetto di movimento.
Lampadina installabile alogena,
fluorescente o led.

Plaster wall light.
Dual emission, curved shape on one
side, giving the effect of movement.
Takes a halogen, fluorescent or LED
light bulb.

Wandleuchte aus Gips.
Bi-Emissions-Licht, gebogene Form
an der Seite, mit Bewegungseffekt.
Halogenlampe, Leuchtstofflampe
oder LED installierbar.

Aplique para pared de yeso.
Doble emisión, forma curva en el
lado, con efecto de movimiento.
Bombilla instalable halógena,
fluorescente o LED.

Настенный светильник из
гипса. Двухнаправленный
светильник с закругленной
сбоку формой и эффектом
движения.
Применяемые лампочки:
галогенная, флуоресцентная
или светодиодная.

Omologazioni
CE V ⊕

Type-approvals
CE V ⊕

Zulassungen
CE V ⊕

Homologaciones
CE V ⊕

Омологации
CE V ⊕

T224
- 2x35W
- G9

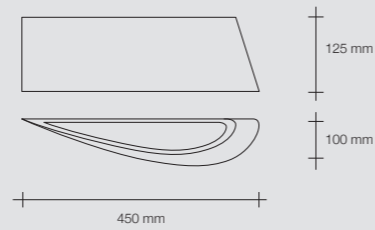





- Lampada da parete gesso biemissione, risulta parte della parete e può essere tinteggiata.
- Lampadina installabile alogena, fluorescente o led con attacco G9.

- Plaster, dual emission wall light, it becomes an integral part of the wall and can be painted.
- Takes a halogen, fluorescent or LED light bulb with G9 connection.

- Wandlampe aus Gips mit Bi-Emissions-Licht, wird eins mit der Wand und kann gestrichen werden.
- Installierbar sind Halogenlampe, Leuchtstofflampe oder Led mit Anschluss G9.

- Aplique para pared de yeso con doble emisión, entra a formar parte de la pared y se puede pintar.
- Acepta bombillas halógenas, fluorescentes o de LED con casquillo G9

- Двухнаправленный настенный светильник из гипса. Он становится частью стены и можно его покрасить.
- Можно устанавливать галогенные, флуоресцентные и светодиодные лампочки с цоколем G9.

Omologazioni
CE V ⊕

Type-approvals
CE V ⊕

Zulassungen
CE V ⊕

Homologaciones
CE V ⊕

Омологации
CE V ⊕

T174.10



- 2X40W
- G9

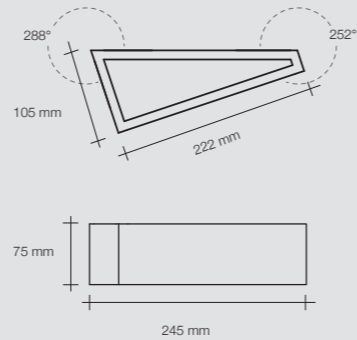

Esempio di prodotto verniciato
Example of painted product
Beispiel für das gestrichene Produkt
Ejemplo de producto pintado
Пример окрашенного прибора





- Lampada da parete gesso biemissione, risulta parte della parete e può essere tinteggiata.
- Lampadina installabile alogena, fluorescente o led con attacco G9.

- Plaster, dual emission wall light, it becomes an integral part of the wall and can be painted.
- Takes a halogen, fluorescent or LED light bulb with G9 connection.

- Wandlampe aus Gips mit Bi-Emissions-Licht, wird eins mit der Wand und kann gestrichen werden.
- Installierbar sind Halogenlampe, Leuchtstofflampe oder Led mit Anschluss G9.

- Aplique para pared de yeso con doble emisión, entra a formar parte de la pared y se puede pintar.
- Acepta bombillas halógenas, fluorescentes o de LED con casquillo G9

- Двухнаправленный настенный светильник из гипса. Он становится частью стены и можно его покрасить.
- Можно устанавливать галогенные, флуоресцентные и светодиодные лампочки с цоколем G9.

Omologazioni
CE V A

Type-approvals
CE V A

Zulassungen
CE V A

Homologaciones
CE V A

Омологации
CE V A

T174.11



- 2X40W
- G9

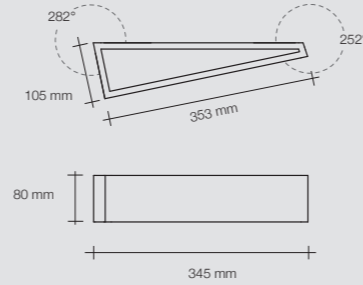



- Lampada da parete gesso biemissione, risulta parte della parete e può essere tinteggiata.
- Lampadina installabile alogena, fluorescente o led con attacco G9.

- Plaster, dual emission wall light, it becomes an integral part of the wall and can be painted.
- Takes a halogen, fluorescent or LED light bulb with G9 connection.

- Wandlampe aus Gips mit Bi-Emissions-Licht, wird eins mit der Wand und kann gestrichen werden.
- Installierbar sind Halogenlampe, Leuchtstofflampe oder Led mit Anschluss G9.

- Aplique para pared de yeso con doble emisión, entra a formar parte de la pared y se puede pintar.
- Acepta bombillas halógenas, fluorescentes o de LED con casquillo G9.

- Двухнаправленный настенный светильник из гипса. Он становится частью стены и можно его покрасить.
- Можно устанавливать галогенные, флуоресцентные и светодиодные лампочки с цоколем G9.

Omologazioni
CE V ⊕

Type-approvals
CE V ⊕

Zulassungen
CE V ⊕

Homologaciones
CE V ⊕

Омологации
CE V ⊕

T174.12



- 3X40W
- G9

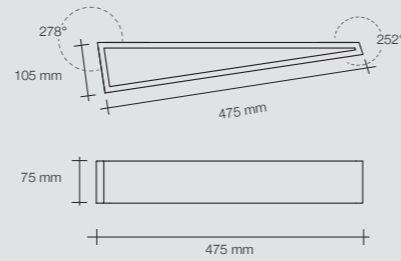



- Lampada da parete gesso biemissione.
- Lampadina installabile alogena, fluorescente o led con attacco G9.

- Plaster, dual emission wall light.
- Takes a halogen, fluorescent or LED light bulb with G9 connection.

- Wandleuchte aus Gips Biemission.
- Installierbare Halogenlampe, Leuchtstofflampe oder LED mit G9 Fassung.

- Aplique para pared de yeso con doble emisión.
- Bombilla instalable halógena, fluorescente o LED con casquillo G9.

- Двухнаправленный настенный светильник из гипса.
- Применяемые лампочки: галогенная, флуоресцентная или светодиодная с цоколем G9.

Omologazioni
CE V

Type-approvals
CE V

Zulassungen
CE V

Homologaciones
CE V

Омологации
CE V

T200



- 1x40W
- G9

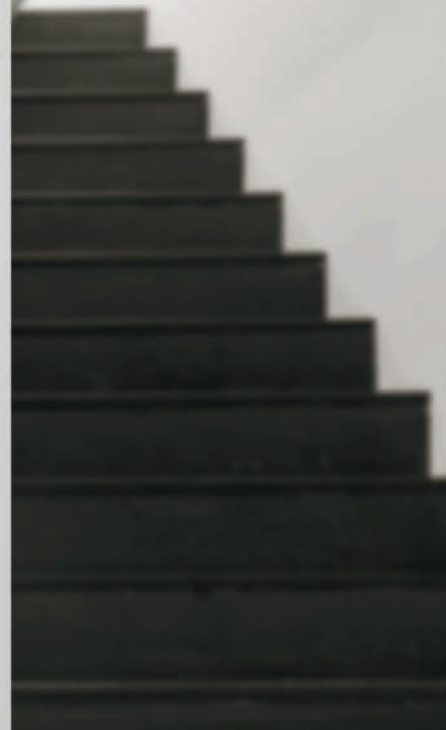
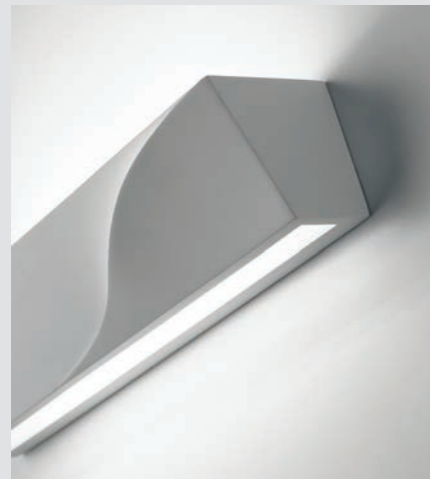
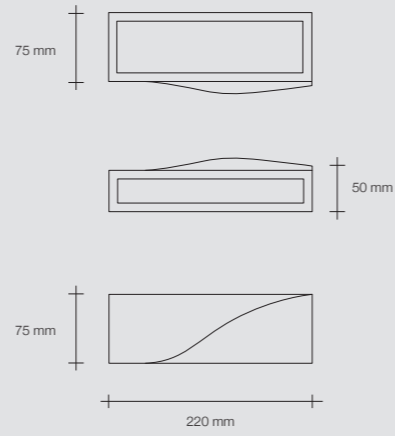



- Lampada da parete gesso biemissione.
- Lampadina installabile alogena, fluorescente o led con attacco G9.

- Plaster, dual emission wall light.
- Takes a halogen, fluorescent or LED light bulb with G9 connection.

- Wandleuchte aus Gips Biemission.
- Installierbare Halogenlampe, Leuchtstofflampe oder LED mit G9 Fassung.

- Aplique para pared de yeso con doble emisión.
- Bombilla instalable halógena, fluorescente o LED con casquillo G9.

- Двухнаправленный настенный светильник из гипса.
- Применяемые лампочки: галогенная, флуоресцентная или светодиодная с цоколем G9.

Omologazioni
CE V ⊕

Type-approvals
CE V ⊕

Zulassungen
CE V ⊕

Homologaciones
CE V ⊕

Омологации
CE V ⊕

T201



- 2x40W
- G9

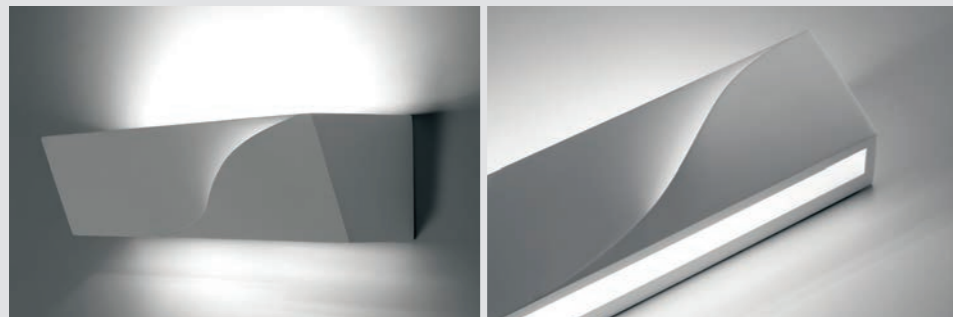
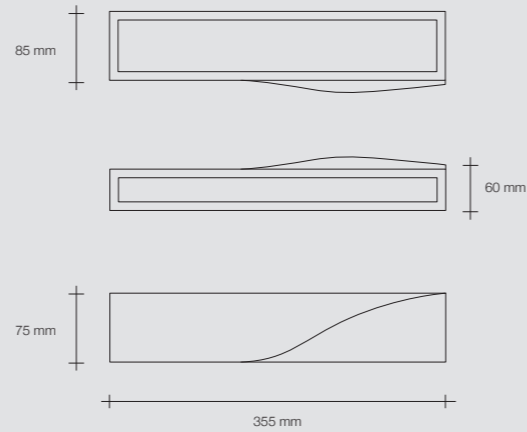



Esempio di prodotto verniciato
Example of painted product
Beispiel für das gestrichene Produkt
Ejemplo de producto pintado
Пример окрашенного прибора



- Lampada da parete gesso biemissione.
- Lampadina installabile alogena, fluorescente o led con attacco G9.

- Plaster, dual emission wall light.
- Takes a halogen, fluorescent or LED light bulb with G9 connection.

- Wandleuchte aus Gips Biemission.
- Installierbare Halogenlampe, Leuchtstofflampe oder LED mit G9 Fassung.

- Aplique para pared de yeso con doble emisión.
- Bombillas instalables halógenas, fluorescentes o LED con casquillo G9.

- Двухнаправленный настенный светильник из гипса.
- Применяемые лампочки: галогенная, флуоресцентная или светодиодная с цоколем G9.

Omologazioni
CE V

Type-approvals
CE V

Zulassungen
CE V

Homologaciones
CE V

Омологации
CE V

T208



- 1x40W
- G9

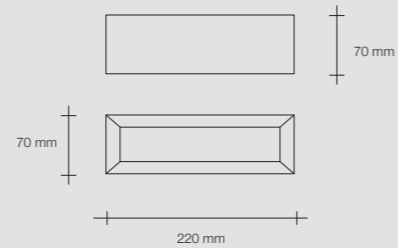



- Lampada da parete gesso biemissione.
- Lampadine installabili alogene, fluorescente o led con attacco G9.

- Plaster, dual emission wall light.
- Takes a halogen, fluorescent or LED light bulb with G9 connection.

- Wandleuchte aus Gips Biemission.
- Installierbare Halogenlampe, Leuchtstofflampe oder LED mit G9 Fassung.

- Aplique para pared de yeso con doble emisión.
- Bombillas instalbles halógenas, fluorescentes o LED con casquillo G9.

- Двухнаправленный настенный светильник из гипса.
- Применяемые лампочки: галогенная, флуоресцентная или светодиодная с цоколем G9.

Omologazioni
CE V ⊕

Type-approvals
CE V ⊕

Zulassungen
CE V ⊕

Homologaciones
CE V ⊕

Омологации
CE V ⊕

T209



- 2x40W
- G9

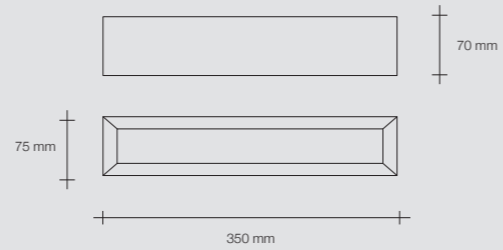

Esempio di prodotto verniciato
Example of painted product
Beispiel für das gestrichene Produkt
Ejemplo de producto pintado
Пример окрашенного прибора





- Lampada da parete gesso biemissione.
- Lampadine installabili alogene, fluorescente o led con attacco G9.

- Plaster, dual emission wall light.
- Takes a halogen, fluorescent or LED light bulb with G9 connection.

- Wandleuchte aus Gips Biemission.
- Installierbare Halogenlampe, Leuchtstofflampe oder LED mit G9 Fassung.

- Aplique para pared de yeso con doble emisión.
- Bombillas instalables halógenas, fluorescentes o LED con casquillo G9.

- Двухнаправленный настенный светильник из гипса.
- Применяемые лампочки: галогенная, флуоресцентная или светодиодная с цоколем G9.

Omologazioni
CE V

Type-approvals
CE V

Zulassungen
CE V

Homologaciones
CE V

Омологации
CE V

T210



- 3x40w
- G9

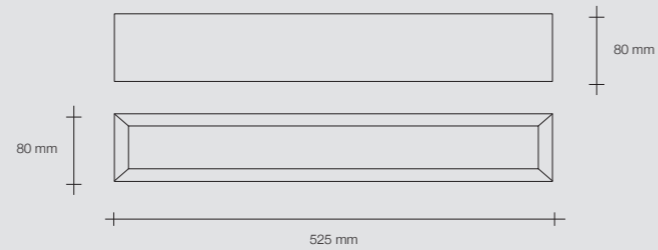

Esempio di prodotto verniciato
Example of painted product
Beispiel für das gestrichene Produkt
Ejemplo de producto pintado
Пример окрашенного прибора

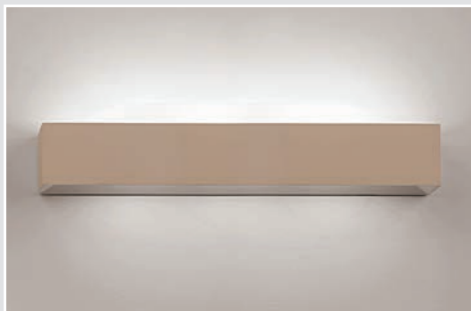



- Lampada da parete in gesso, risulta parte della parete e può essere tinteggiata.
- Lampadina installabile alogena, fluorescente o led con attacco G9.

- Plaster wall light, it becomes an integral part of the wall and can be painted.
- Takes a halogen, fluorescent or LED light bulb with G9 connection.

- Wandlampe aus Gips, wird zu einem integrierenden Bestandteil der Wand und kann angestrichen werden.
- Installierbar sind Halogenlampe, Leuchtstofflampe oder Led mit Anschluss G9.

- Aplique para pared de yeso, entra a formar parte de la pared y se puede pintar.
- Acepta bombillas halógenas, fluorescentes o de LED con casquillo G9.

- Гипсовая лампа для потолка, станет неотъемлемой частью самого потолка и ее можно покрасить.
- Можно устанавливать галогенные, флуоресцентные и светодиодные лампочки с цоколем G9.

Omologazioni
CE V

Type-approvals
CE V

Zulassungen
CE V

Homologaciones
CE V

Омологации
CE V

T98



- 1X60W
- G9

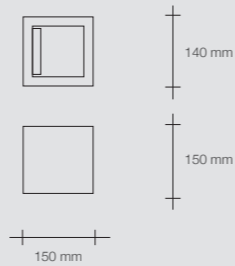

Esempio di prodotto verniciato
Example of painted product
Beispiel für das gestrichene Produkt
Ejemplo de producto pintado
Пример окрашенного прибора

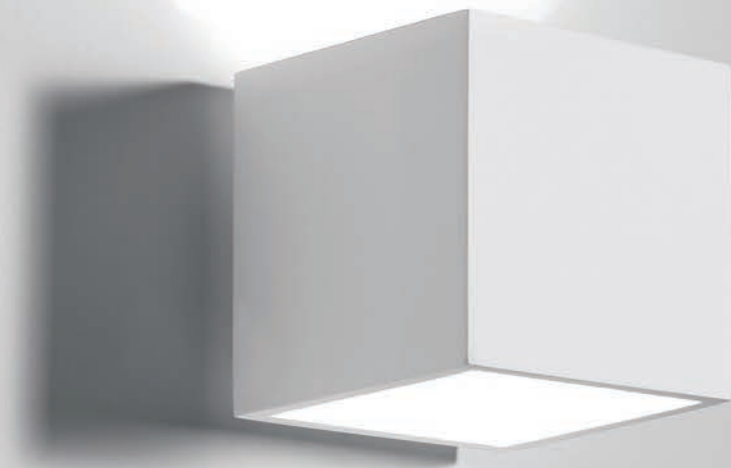
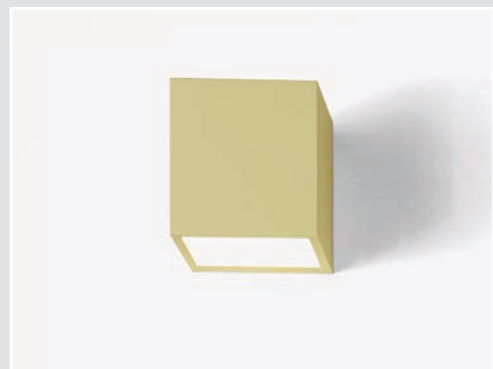



- Lampada da parete gesso biemissione.
- Lampadina installabile alogena, fluorescente o led con attacco G9.

- Plaster, dual emission wall lamp.
- Takes a halogen, fluorescent or LED light bulb with G9 connection.

- Wandleuchte aus Gips Biemission.
- Installierbare Halogenlampe, Leuchtstofflampe oder LED mit G9 Fassung.

- Aplique para pared de yeso con doble emisión.
- Bombilla instalable halógena, fluorescente o LED con casquillo G9.

- Двухнаправленный настенный светильник из гипса.
- Применяемые лампочки: галогенная, флуоресцентная или светодиодная с цоколем G9.

Omologazioni

CE V

Type-approvals

CE V

Zulassungen

CE V

Homologaciones

CE V

Омологации

CE V

T195



- 1X40 W
- G9

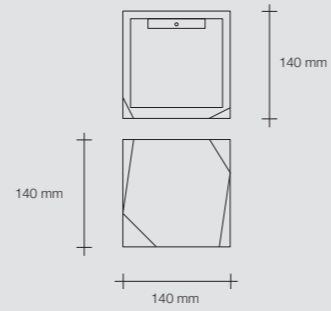

MANTINEA



- Lampada da parete in gesso, risulta parte della parete e può essere tinteggiata.
- Lampadina installabile ologena, fluorescente o led con attacco E27.

- Plaster wall light, it becomes an integral part of the wall and can be painted.
- Takes a halogen, fluorescent or LED light bulb with E27 connection.

- Wandlampe aus Gips, wird zu einem integrierenden Bestandteil der Wand und kann angestrichen werden.
- Installierbar sind Halogenlampe, Leuchtstofflampe oder Led mit Anschluss E27.

- Aplique para pared de yeso, entra a formar parte de la pared y se puede pintar.
- Acepta bombillas halógenas, fluorescentes o de LED con casquillo E27.

- Гипсовая лампа для потолка, станет неотъемлемой частью самого потолка и ее можно покрасить.
- Можно устанавливать галогенные, флуоресцентные и светодиодные лампочки с цоколем E27.

Omologazioni
CE V

Type-approvals
CE V

Zulassungen
CE V

Homologaciones
CE V

Омолгации
CE V

T106



- 1X60W
- E27

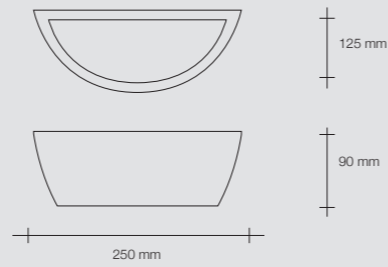

Listino prezzi per tipologia

Pricelist by type









Preisliste nach typ







Lista de precios por tipo





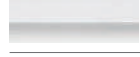



Прайс-лист по типу







ESTRUSI LED



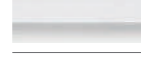

LED extruded range
Stranggepresst mit LED
Extrudidos LED
Светодиодные экструдированные светильники







EMATHIA INCASSO WHITE		Catalogo Catalogue Katalog Catálogo Каталог	IVA inclusa Including VAT Inklusive MWST IVA incluido НДС включен	Senza IVA Excluding VAT Ohne MWST IVA excluido Без НДС
 T133.W.50.OPAL	pag. 31	€ 46,50	€ 38,11	
 T133.W.50.SAT	pag. 31	€ 46,50	€ 38,11	
 T133.W.100.OPAL	pag. 31	€ 93,00	€ 76,23	
 T133.W.100.SAT	pag. 31	€ 93,00	€ 76,23	
 T133.W.150.OPAL	pag. 31	€ 139,50	€ 114,34	
 T133.W.150.SAT	pag. 31	€ 139,50	€ 114,34	
 T133.W.200.OPAL	pag. 31	€ 186,00	€ 152,46	
 T133.W.200.SAT	pag. 31	€ 186,00	€ 152,46	
T133.TAGLIO	pag. 31	€ 20,00	€ 16,39	





EUBEA INCASSO WHITE		Catalogo Catalogue Katalog Catálogo Каталог	IVA inclusa Including VAT Inklusive MWST IVA incluido НДС включен	Senza IVA Excluding VAT Ohne MWST IVA excluido Без НДС
 T139.W.50.OPAL	pag. 35	€ 36,00	€ 29,51	
 T139.W.50.SAT	pag. 35	€ 36,00	€ 29,51	
 T139.W.100.OPAL	pag. 35	€ 71,00	€ 58,20	
 T139.W.100.SAT	pag. 35	€ 71,00	€ 58,20	
 T139.W.150.OPAL	pag. 35	€ 106,00	€ 86,89	
 T139.W.150.SAT	pag. 35	€ 106,00	€ 86,89	
 T139.W.200.OPAL	pag. 35	€ 141,00	€ 115,57	
 T139.W.200.SAT	pag. 35	€ 141,00	€ 115,57	
T133.TAGLIO	pag. 35	€ 20,00	€ 16,39	









EMATHIA INCASSO ALUMINIUM		Catalogo Catalogue Katalog Catálogo Каталог	IVA inclusa Including VAT Inklusive MWST IVA incluido НДС включен	Senza IVA Excluding VAT Ohne MWST IVA excluido Без НДС
 T133.AL.50.OPAL	pag. 31	€ 46,50	€ 38,11	
 T133.AL.50.SAT	pag. 31	€ 46,50	€ 38,11	
 T133.AL.100.OPAL	pag. 31	€ 93,00	€ 76,23	
 T133.AL.100.SAT	pag. 31	€ 93,00	€ 76,23	
 T133.AL.150.OPAL	pag. 31	€ 139,50	€ 114,34	
 T133.AL.150.SAT	pag. 31	€ 139,50	€ 114,34	
 T133.AL.200.OPAL	pag. 31	€ 186,00	€ 152,46	
 T133.AL.200.SAT	pag. 31	€ 186,00	€ 152,46	
T133.TAGLIO	pag. 31	€ 20,00	€ 16,39	

EUBEA INCASSO ALUMINIUM		Catalogo Catalogue Katalog Catálogo Каталог	IVA inclusa Including VAT Inklusive MWST IVA incluido НДС включен	Senza IVA Excluding VAT Ohne MWST IVA excluido Без НДС
 T139.AL.50.OPAL	pag. 35	€ 36,00	€ 29,51	
 T139.AL.50.SAT	pag. 35	€ 36,00	€ 29,51	
 T139.AL.100.OPAL	pag. 35	€ 71,00	€ 58,20	
 T139.AL.100.SAT	pag. 35	€ 71,00	€ 58,20	
 T139.AL.150.OPAL	pag. 35	€ 106,00	€ 86,89	
 T139.AL.150.SAT	pag. 35	€ 106,00	€ 86,89	
 T139.AL.200.OPAL	pag. 35	€ 141,00	€ 115,57	
 T139.AL.200.SAT	pag. 35	€ 141,00	€ 115,57	
T133.TAGLIO	pag. 35	€ 20,00	€ 16,39	

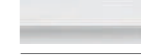
OROPUS INCASSO WHITE		Catalogo Catalogue Katalog Catálogo Каталог	IVA inclusa Including VAT Inklusive MWST IVA incluido НДС включен	Senza IVA Excluding VAT Ohne MWST IVA excluido Без НДС
 T221.W.50.SAT	pag. 39	€ 22,00	€ 18,03	
 T221.W.100.SAT	pag. 39	€ 43,00	€ 35,16	
 T221.W.150.SAT	pag. 39	€ 66,00	€ 54,10	
 T221.W.200.SAT	pag. 39	€ 86,00	€ 70,33	
T133.TAGLIO	pag. 39	€ 20,00	€ 16,39	

EUBEA ESTERNO WHITE		Catalogo Catalogue Katalog Catálogo Каталог	IVA inclusa Including VAT Inklusive MWST IVA incluido НДС включен	Senza IVA Excluding VAT Ohne MWST IVA excluido Без НДС
 T145.W.50.OPAL	pag. 43	€ 33,00	€ 27,05	
 T145.W.50.SAT	pag. 43	€ 33,00	€ 27,05	
 T145.W.100.OPAL	pag. 43	€ 64,50	€ 52,87	
 T145.W.100.SAT	pag. 43	€ 64,50	€ 52,87	
 T145.W.150.OPAL	pag. 43	€ 97,00	€ 79,51	
 T145.W.150.SAT	pag. 43	€ 97,00	€ 79,51	
 T145.W.200.OPAL	pag. 43	€ 129,00	€ 105,74	
 T145.W.200.SAT	pag. 43	€ 129,00	€ 105,74	
T133.TAGLIO	pag. 43	€ 20,00	€ 16,39	

OROPUS INCASSO ALUMINIUM		Catalogo Catalogue Katalog Catálogo Каталог	IVA inclusa Including VAT Inklusive MWST IVA incluido НДС включен	Senza IVA Excluding VAT Ohne MWST IVA excluido Без НДС
 T221.AL.50.SAT	pag. 39	€ 22,00	€ 18,03	
 T221.AL.100.SAT	pag. 39	€ 43,00	€ 35,16	
 T221.AL.150.SAT	pag. 39	€ 66,00	€ 54,10	
 T221.AL.200.SAT	pag. 39	€ 86,00	€ 70,33	
T133.TAGLIO	pag. 39	€ 20,00	€ 16,39	



EUBEA ESTERNO ALUMINIUM		Catalogo Catalogue Katalog Catálogo Каталог	IVA inclusa Including VAT Inklusive MWST IVA incluido НДС включен	Senza IVA Excluding VAT Ohne MWST IVA excluido Без НДС
 T145.AL.50.OPAL	pag. 43	€ 33,00	€ 27,05	
 T145.AL.50.SAT	pag. 43	€ 33,00	€ 27,05	
 T145.AL.100.OPAL	pag. 43	€ 64,50	€ 52,87	
 T145.AL.100.SAT	pag. 43	€ 64,50	€ 52,87	
 T145.AL.150.OPAL	pag. 43	€ 97,00	€ 79,51	
 T145.AL.150.SAT	pag. 43	€ 97,00	€ 79,51	
 T145.AL.200.OPAL	pag. 43	€ 129,00	€ 105,74	
 T145.AL.200.SAT	pag. 43	€ 129,00	€ 105,74	
T133.TAGLIO	pag. 43	€ 20,00	€ 16,39	



ESTRUSI LED

LED extruded range
Stranggepresst mit LED
Extrudidos LED
Светодиодные экструдированные светильники

CHALCIS ESTERNO WHITE		Catalogo Catalogue Katalog Catálogo Каталог	IVA inclusa Including VAT Inklusive MWST IVA incluido НДС включен	Senza IVA Excluding VAT Ohne MWST IVA excluido Без НДС
	T220.W.50.SAT	pag. 47	€ 17,00	€ 13,93
	T220.W.100.SAT	pag. 47	€ 33,00	€ 27,05
	T220.W.150.SAT	pag. 47	€ 50,00	€ 40,57
	T220.W.200.SAT	pag. 47	€ 66,00	€ 54,10
	T133.TAGLIO	pag. 47	€ 20,00	€ 16,39

CHALCIS ESTERNO ALUMINIUM		Catalogo Catalogue Katalog Catálogo Каталог	IVA inclusa Including VAT Inklusive MWST IVA incluido НДС включен	Senza IVA Excluding VAT Ohne MWST IVA excluido Без НДС
	T220.AL.50.SAT	pag. 47	€ 17,00	€ 13,93
	T220.AL.100.SAT	pag. 47	€ 33,00	€ 27,05
	T220.AL.150.SAT	pag. 47	€ 50,00	€ 40,57
	T220.AL.200.SAT	pag. 47	€ 66,00	€ 54,10
	T133.TAGLIO	pag. 47	€ 20,00	€ 16,39

LED Strip Led 3000° K		Catalogo Catalogue Katalog Catálogo Каталог	IVA inclusa Including VAT Inklusive MWST IVA incluido НДС включен	Senza IVA Excluding VAT Ohne MWST IVA excluido Без НДС
	T397.1M.3000	pag. 31	€ 18,00	€ 14,75
	T397.2M.3000	pag. 31	€ 35,00	€ 28,69
	T397.3M.3000	pag. 31	€ 52,00	€ 42,62
	T397.4M.3000	pag. 31	€ 69,00	€ 56,56
	T397.5M.3000	pag. 31	€ 86,00	€ 70,49
	T398.1M.3000	pag. 31	€ 23,00	€ 18,85
	T398.2M.3000	pag. 31	€ 46,00	€ 37,70
	T398.3M.3000	pag. 31	€ 69,00	€ 56,56
	T398.4M.3000	pag. 31	€ 92,00	€ 75,41
	T398.5M.3000	pag. 31	€ 114,00	€ 93,44

LED Strip Led 4000° K		Catalogo Catalogue Katalog Catálogo Каталог	IVA inclusa Including VAT Inklusive MWST IVA incluido НДС включен	Senza IVA Excluding VAT Ohne MWST IVA excluido Без НДС
	T397.1M.4000	pag. 31	€ 18,00	€ 14,75
	T397.2M.4000	pag. 31	€ 35,00	€ 28,69
	T397.3M.4000	pag. 31	€ 52,00	€ 42,62
	T397.4M.4000	pag. 31	€ 69,00	€ 56,56
	T397.5M.4000	pag. 31	€ 86,00	€ 70,49
	T398.1M.4000	pag. 31	€ 23,00	€ 18,85
	T398.2M.4000	pag. 31	€ 46,00	€ 37,70
	T398.3M.4000	pag. 31	€ 69,00	€ 56,56
	T398.4M.4000	pag. 31	€ 92,00	€ 75,41
	T398.5M.4000	pag. 31	€ 114,00	€ 93,44

METHONI ESTERNO ALUMINIUM		Catalogo Catalogue Katalog Catálogo Каталог	IVA inclusa Including VAT Inklusive MWST IVA incluido НДС включен	Senza IVA Excluding VAT Ohne MWST IVA excluido Без НДС
	T309.AL.50.OPAL	pag. 51	€ 20,00	€ 16,39
	T309.AL.100.OPAL	pag. 51	€ 40,00	€ 32,79
	T309.AL.150.OPAL	pag. 51	€ 60,00	€ 49,18
	T309.AL.200.OPAL	pag. 51	€ 79,00	€ 64,75
	T133.TAGLIO	pag. 51	€ 20,00	€ 16,39









ICUS ESTERNO ALUMINIUM		Catalogo Catalogue Katalog Catálogo Каталог	IVA inclusa Including VAT Inklusive MWST IVA incluido НДС включен	Senza IVA Excluding VAT Ohne MWST IVA excluido Без НДС
	T310.AL.50.OPAL	pag. 55	€ 16,00	€ 13,11
	T310.AL.100.OPAL	pag. 55	€ 32,00	€ 26,23
	T310.AL.150.OPAL	pag. 55	€ 47,00	€ 38,52
	T310.AL.200.OPAL	pag. 55	€ 63,00	€ 51,64
	T133.TAGLIO	pag. 55	€ 20,00	€ 16,39

ALIMENTATORI Power supply units - Netzgeräte Fuentes de alimentación Блоки питания		Catalogo Catalogue Katalog Catálogo Каталог	IVA inclusa Including VAT Inklusive MWST IVA incluido НДС включен	Senza IVA Excluding VAT Ohne MWST IVA excluido Без НДС
	T73.40W.24.DIM	pag. 31	€ 97,00	€ 79,51
	T73.100W.24.DIM	pag. 31	€ 146,00	€ 119,67
	T73.150W.24.DIM	pag. 31	€ 153,00	€ 125,41
	T73.240W.24.DIM	pag. 31	€ 192,00	€ 157,38
	T73.320W.24.DIM	pag. 31	€ 261,00	€ 213,93

ALIMENTATORI Power supply units - Netzgeräte Fuentes de alimentación Блоки питания		Catalogo Catalogue Katalog Catálogo Каталог	IVA inclusa Including VAT Inklusive MWST IVA incluido НДС включен	Senza IVA Excluding VAT Ohne MWST IVA excluido Без НДС
	T73.50W.24.SNP	pag. 31	€ 58,00	€ 47,54
	T73.100W.24.SNP	pag. 31	€ 108,00	€ 88,52
	T73.150W.24.SNP	pag. 31	€ 102,00	€ 83,61
	T73.200W.24.SNP	pag. 31	€ 163,00	€ 133,61
	T73.320W.24.SNP	pag. 31	€ 237,00	€ 194,26









PROFILI LINEARI

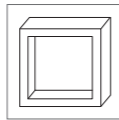



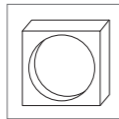





Linear profiles
Lineare Profile
Perfiles lineales
Линейные профили











	Catalogo Catalogue Katalóg Каталог	IVA inclusa Including VAT Inklusive MWST IVA incluido НДС включен	Senza IVA Excluding VAT Ohne MWST IVA excluido Без НДС
 T311.10 Pirog	pag. 62	€ 272,00	€ 222,95
 T311.10 D Pirog	pag. 62	€ 347,00	€ 284,43
 T311.11 Pirog	pag. 62	€ 356,00	€ 291,80
 T311.11 D Pirog	pag. 62	€ 431,00	€ 353,28
 T311.30 Pirog	pag. 66	€ 323,00	€ 264,75
 T311.30 D Pirog	pag. 66	€ 398,00	€ 326,23
 T311.31 Pirog	pag. 66	€ 408,00	€ 334,43
 T311.31 D Pirog	pag. 66	€ 483,00	€ 395,90
 T311.50 Pirog	pag. 70	€ 569,00	€ 466,39

INCASSI SOFFITTO GESSO

Recessed ceiling range in plaster
Zum Einlassen an der Decke aus Gips
Empotrados techo yeso
Встраиваемые светильники для гипсокартонных



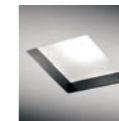
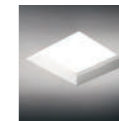

	Catalogo Catalogue Katalóg Каталог	IVA inclusa Including VAT Inklusive MWST IVA incluido НДС включен	Senza IVA Excluding VAT Ohne MWST IVA excluido Без НДС
 T01 Micene	pag. 198	€ 21,00	€ 17,21
 T01 C Cassaforma Formwork	pag. 198	€ 47,00	€ 38,52
 T04 Attica	pag. 192	€ 21,00	€ 17,21
 T10 Polis	pag. 186	€ 21,00	€ 17,21
 T22 Nicia	pag. 188	€ 18,00	€ 14,75
 T28 Attica Glass	pag. 194	€ 21,00	€ 17,21
 T31 C Cassaforma Formwork	pag. 200	€ 91,00	€ 74,59
 T32 2E27 Cadmea	pag. 200	€ 118,00	€ 96,72
 T51 G24q3-2X26W Cadmea	pag. 200	€ 297,00	€ 243,44
 T93 Sparta	pag. 182	€ 21,00	€ 17,21
 T165 Siris	pag. 180	€ 19,00	€ 15,57

	Catalogo Catalogue Katalóg Каталог	IVA inclusa Including VAT Inklusive MWST IVA incluido НДС включен	Senza IVA Excluding VAT Ohne MWST IVA excluido Без НДС
 T177 Attica Orientabile	pag. 196	€ 46,00	€ 37,70
 T232 Olympia raso	pag. 170	€ 36,00	€ 29,51
 T233 Olympia raso	pag. 172	€ 83,00	€ 68,03
 T235 Olympia dentino	pag. 174	€ 69,00	€ 56,56
 T236 Olympia dentino	pag. 176	€ 91,00	€ 74,59
 T255 Heraea	pag. 158	€ 83,00	€ 68,03
 T256 Heraea	pag. 162	€ 105,00	€ 86,07
 T257 Heraea	pag. 166	€ 163,00	€ 133,61
 T332 Thessaly	pag. 126	€ 26,00	€ 21,31
 T334 Thessaly	pag. 130	€ 26,00	€ 21,31
 T335 Thessaly	pag. 134	€ 26,00	€ 21,31

	Catalogo Catalogue Katalóg Каталог	IVA inclusa Including VAT Inklusive MWST IVA incluido НДС включен	Senza IVA Excluding VAT Ohne MWST IVA excluido Без НДС
 T336 Thessaly	pag. 138	€ 26,00	€ 21,31
 T337 Filiatrá	pag. 80	€ 19,00	€ 15,57
 T338 Filiatrá	pag. 84	€ 25,00	€ 20,49
 T353 Doride	pag. 150	€ 31,00	€ 25,41
 T354 Doride	pag. 154	€ 33,00	€ 27,05
 T356 Lelanto	pag. 142	€ 31,00	€ 25,41
 T357 Lelanto	pag. 146	€ 61,00	€ 50,00
 T381 Filiatrá	pag. 92	€ 26,00	€ 21,31
 T382 Filiatrá	pag. 96	€ 33,00	€ 27,05
 T383 Filiatrá	pag. 100	€ 27,00	€ 22,13
 T384 Phocis	pag. 104	€ 31,00	€ 25,41

INCASSI SOFFITTO GESSO

Recessed ceiling range in plaster
Zum Einlassen an der Decke aus Gips
Empotrados techo yeso
Встраиваемые светильники для гипсокартонных

	Catalogo Catalogue Katalog Каталог	IVA inclusa Including VAT Inklusive MWST IVA incluido НДС включен	Senza IVA Excluding VAT Ohne MWST IVA excluido Без НДС
 T390 Thessaly	pag. 110	€ 26,00	€ 21,31
 T391 Thessaly	pag. 114	€ 26,00	€ 21,31
 T392 Thessaly	pag. 118	€ 26,00	€ 21,31
 T393 Thessaly	pag. 122	€ 26,00	€ 21,31











INCASSI PARETE GESSO







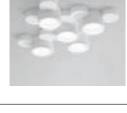
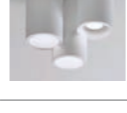



Recessed wall range in plaster
Zum Einlassen an der Wand aus Gips
Empotrados pared yeso
Встраиваемые светильники для гипсокартонных стен

	Catalogo Catalogue Katalog Каталог	IVA inclusa Including VAT Inklusive MWST IVA incluido НДС включен	Senza IVA Excluding VAT Ohne MWST IVA excluido Без НДС
 T76 Sipario	pag. 204	€ 99,00	€ 81,15
 T76 C Cassaforma	pag. 204	€ 85,00	€ 69,67

GESSI SOFFITTO





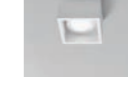





Ceiling range in plaster
Gipslampen Decke
Yesos techo
Гипсовые потолочные светильники









	Catalogo Catalogue Katalog Каталог	IVA inclusa Including VAT Inklusive MWST IVA incluido НДС включен	Senza IVA Excluding VAT Ohne MWST IVA excluido Без НДС
 T179 Esiodo Micro	pag. 448	€ 46,00	€ 37,70
 T193 Heraea	pag. 438	€ 93,00	€ 76,23
 T194 Heraea	pag. 440	€ 149,00	€ 122,13
 T258 Elide	pag. 428	€ 38,00	€ 31,15
 T259 Elide	pag. 430	€ 70,00	€ 57,38
 T260 Elide	pag. 432	€ 100,00	€ 81,97
 T262 Chio	pag. 354	€ 127,00	€ 104,10
 T263 Chio	pag. 356	€ 154,00	€ 126,23
 T264 Chio	pag. 358	€ 275,00	€ 225,41
 T265 Arta	pag. 452	€ 100,00	€ 81,97
 T266 Arta	pag. 454	€ 150,00	€ 122,95

	Catalogo Catalogue Katalog Каталог	IVA inclusa Including VAT Inklusive MWST IVA incluido НДС включен	Senza IVA Excluding VAT Ohne MWST IVA excluido Без НДС
 T267 Lepreum	pag. 420	€ 68,00	€ 55,74
 T268 Lepreum	pag. 422	€ 99,00	€ 81,15
 T271 Heraea	pag. 434	€ 125,00	€ 102,46
 T273 Heraea	pag. 436	€ 155,00	€ 127,05
 T274 Chio	pag. 350	€ 47,00	€ 38,52
 T278 Chio	pag. 352	€ 88,00	€ 72,13
 T287 Lepreum	pag. 424	€ 167,00	€ 136,89
 T291 Side	pag. 382	€ 70,00	€ 57,38
 T292 Side	pag. 384	€ 127,00	€ 104,10
 T293 Side	pag. 386	€ 172,00	€ 140,98
 T294 Mylasa	pag. 408	€ 39,00	€ 31,97

GESI SOFFITTO











Ceiling range in plaster
Gipslampen Decke
Yesos techo
Гипсовые потолочные светильники











	Catálogo Catalogue Katalóg Каталог	IVA inclusa Including VAT Inklusive MWST IVA incluido НДС включен	Senza IVA Excluding VAT Ohne MWST IVA excludido Без НДС
 T295 Mylasa	pag. 410	€ 67,00	€ 54,92
 T296 Mylasa	pag. 412	€ 95,00	€ 77,87
 T303 Lepreum	pag. 426	€ 221,00	€ 181,15
 T312 Tenedos	pag. 414	€ 40,00	€ 32,79
 T313 Tenedos	pag. 416	€ 80,00	€ 65,57
 T314 Tenedos	pag. 418	€ 119,00	€ 97,54
 T339 Demetra	pag. 280	€ 35,00	€ 28,69
 T358 Demetra	pag. 284	€ 57,00	€ 46,72
 T359 Demetra	pag. 288	€ 80,00	€ 65,57
 T371 Anchise	pag. 330	€ 35,00	€ 28,69

	Catálogo Catalogue Katalóg Каталог	IVA inclusa Including VAT Inklusive MWST IVA incluido НДС включен	Senza IVA Excluding VAT Ohne MWST IVA excludido Без НДС
 T372 Anchise	pag. 334	€ 60,00	€ 49,18
 T373 Anchise	pag. 338	€ 88,00	€ 72,13
 T377 Sibari	pag. 310	€ 50,00	€ 40,98
 T378 Sibari	pag. 314	€ 75,00	€ 61,48
 T387 Cicladi	pag. 224	€ 50,00	€ 40,98
 T388 Cicladi	pag. 228	€ 93,00	€ 76,23
 T389 Cicladi	pag. 232	€ 134,00	€ 109,84
 T401 Pitane	pag. 256	€ 89,00	€ 72,95
 T402 Pitane	pag. 260	€ 123,00	€ 100,82

GESI PARETE











Wall range in plaster
Gipslampen Wand
Yesos pared
Гипсовые настенные светильники

	Catálogo Catalogue Katalóg Каталог	IVA inclusa Including VAT Inklusive MWST IVA incluido НДС включен	Senza IVA Excluding VAT Ohne MWST IVA excludido Без НДС
 T98 Ionia	pag. 490	€ 63,00	€ 51,64
 T106 Mantinea	pag. 494	€ 58,00	€ 47,54
 T174.10 Teos	pag. 472	€ 55,00	€ 45,08
 T174.11 Teos	pag. 474	€ 68,00	€ 55,74
 T174.12 Teos	pag. 476	€ 94,00	€ 77,05
 T195 Opus	pag. 492	€ 64,00	€ 52,46
 T200 Pellene	pag. 478	€ 57,00	€ 46,72
 T201 Pellene	pag. 480	€ 77,00	€ 63,11
 T203 Sicyon	pag. 450	€ 46,00	€ 37,70
 T205 Heraea	pag. 442	€ 117,00	€ 95,90
 T206 Heraea	pag. 444	€ 92,00	€ 75,41

	Catálogo Catalogue Katalóg Каталог	IVA inclusa Including VAT Inklusive MWST IVA incluido НДС включен	Senza IVA Excluding VAT Ohne MWST IVA excludido Без НДС
 T207 Heraea	pag. 446	€ 112,00	€ 91,80
 T208 Hermione	pag. 484	€ 42,00	€ 34,43
 T209 Hermione	pag. 486	€ 58,00	€ 47,54
 T210 Hermione	pag. 488	€ 70,00	€ 57,38
 T222 Delfi	pag. 466	€ 55,00	€ 45,08
 T223 Delfi	pag. 467	€ 72,00	€ 59,02
 T224 Delfi	pag. 468	€ 93,00	€ 76,23
 T253 Arta	pag. 456	€ 96,00	€ 78,69
 T254 Arta	pag. 458	€ 146,00	€ 119,67
 T269 Paro	pag. 460	€ 99,00	€ 81,15
 T270 Paro	pag. 462	€ 165,00	€ 135,25

GESSI PARETE

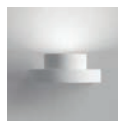
Wall range in plaster
Gipslampen Wand
Yesos pared
Гипсовые настенные светильники

	Catalogo Catalogue Katalóg Каталог	IVA inclusa Including VAT Inklusive MWST IVA incluido НДС включен	Senza IVA Excluding VAT Ohne MWST IVA excluido Без НДС
 T319 Chio	pag. 364	€ 52,00	€ 42,62
 T320 Chio	pag. 368	€ 96,00	€ 78,69
 T321 Chio	pag. 372	€ 96,00	€ 78,69
 T322 Chio	pag. 376	€ 146,00	€ 119,67
 T323 Side	pag. 392	€ 57,00	€ 46,72
 T324 Side	pag. 396	€ 104,00	€ 85,25
 T325 Side	pag. 400	€ 96,00	€ 78,69
 T326 Side	pag. 404	€ 152,00	€ 124,59
 T360 Demetra	pag. 296	€ 46,00	€ 37,70
 T361 Demetra	pag. 300	€ 66,00	€ 54,10
 T362 Demetra	pag. 304	€ 66,00	€ 54,10

	Catalogo Catalogue Katalóg Каталог	IVA inclusa Including VAT Inklusive MWST IVA incluido НДС включен	Senza IVA Excluding VAT Ohne MWST IVA excluido Без НДС
 T374 Anchise	pag. 342	€ 42,00	€ 34,43
 T375 Anchise	pag. 346	€ 63,00	€ 51,64
 T379 Sibari	pag. 318	€ 42,00	€ 34,43
 T380 Sibari	pag. 322	€ 62,00	€ 50,82
 T394 Patra	pag. 212	€ 33,00	€ 27,05
 T395 Patra	pag. 216	€ 57,00	€ 46,72
 T385 Cicladi	pag. 240	€ 51,00	€ 41,80
 T386 Cicladi	pag. 244	€ 95,00	€ 77,87
 T396 Cicladi	pag. 248	€ 95,00	€ 77,87
 T399 Pitane	pag. 268	€ 48,00	€ 39,34
 T400 Pitane	pag. 272	€ 89,00	€ 72,95

Listino prezzi per codice

Pricelist by code
Preisliste nach code
Lista de precios por código
Прайс-лист по кодам

LISTINO PREZZI PER CODICE

Pricelist by code
Preislste nach code
Lista de precios por código
Прайс-лист по кодам

		Catalogo Catalogue Katalog Catálogo Каталог	IVA inclusa Including VAT Inklusive MWST IVA incluido НДС включен	Senza IVA Excluding VAT Ohne MWST IVA excludido Без НДС
T01	Micene	pag. 198	€ 21,00	€ 17,21
T01 C	Cassaforma	pag. 198	€ 47,00	€ 38,52
T04	Attica	pag. 192	€ 21,00	€ 17,21
T10	Polis	pag. 186	€ 21,00	€ 17,21
T22	Nicia	pag. 188	€ 18,00	€ 14,75
T28	Attica Glass	pag. 194	€ 21,00	€ 17,21
T31 C	Cassaforma	pag. 200	€ 91,00	€ 74,59
T32 2E27	Cadmea	pag. 200	€ 118,00	€ 96,72
T51 G24Q3-2X26W	Cadmea	pag. 200	€ 297,00	€ 243,44
T73.40W.24.DIM	Alimentatori 40W Dim.	pag. 31	€ 97,00	€ 79,51
T73.100W.24.DIM	Alimentatori 100W Dim.	pag. 31	€ 146,00	€ 119,67
T73.150W.24.DIM	Alimentatori 150W Dim.	pag. 31	€ 153,00	€ 125,41
T73.240W.24.DIM	Alimentatori 240W Dim.	pag. 31	€ 192,00	€ 157,38
T73.320W.24.DIM	Alimentatori 320W Dim.	pag. 31	€ 261,00	€ 213,93
T73.50W.24.SNP	Alimentatori 50W SNAPPY	pag. 31	€ 58,00	€ 47,54
T73.100W.24.SNP	Alimentatori 100W SNAPPY	pag. 31	€ 108,00	€ 88,52
T73.150W.24.SNP	Alimentatori 150W SNAPPY	pag. 31	€ 102,00	€ 83,61
T73.200W.24.SNP	Alimentatori 200W SNAPPY	pag. 31	€ 163,00	€ 133,61
T73.320W.24.SNP	Alimentatori 320W SNAPPY	pag. 31	€ 237,00	€ 194,26
T76	Sipario	pag. 204	€ 99,00	€ 81,15
T76 C	Cassaforma	pag. 204	€ 85,00	€ 69,67
T93	Sparta	pag. 182	€ 21,00	€ 17,21
T98	Ionia	pag. 490	€ 63,00	€ 51,64
T106	Mantineia	pag. 494	€ 58,00	€ 47,54
T133	Taglio	pag. 31	€ 46,50	€ 38,11
T133.AL.....	Emathia Incasso Aluminium	pag. 31	€ 46,50	€ 38,11

		Catalogo Catalogue Katalog Catálogo Каталог	IVA inclusa Including VAT Inklusive MWST IVA incluido НДС включен	Senza IVA Excluding VAT Ohne MWST IVA excludido Без НДС
T133.W....	Emathia Incasso White	pag. 31	€ 46,50	€ 38,11
T139.AL...	Eubea Incasso Aluminium	pag. 35	€ 36,00	€ 29,51
T139.W...	Eubea Incasso White	pag. 35	€ 36,00	€ 29,51
T145.AL...	Eubea Esterno Aluminium	pag. 43	€ 33,00	€ 27,05
T145.W...	Eubea Esterno White	pag. 43	€ 33,00	€ 27,05
T165	Siris	pag. 180	€ 19,00	€ 15,57
T174.10	Teos	pag. 472	€ 55,00	€ 45,08
T174.11	Teos	pag. 474	€ 68,00	€ 55,74
T174.12	Teos	pag. 476	€ 94,00	€ 77,05
T177	Attica Orientabile	pag. 196	€ 46,00	€ 37,70
T179	Esiodo Micro	pag. 448	€ 46,00	€ 37,70
T193	Heraea	pag. 438	€ 93,00	€ 76,23
T194	Heraea	pag. 440	€ 149,00	€ 122,13
T195	Opus	pag. 492	€ 64,00	€ 52,46
T200	Pellene	pag. 478	€ 57,00	€ 46,72
T201	Pellene	pag. 480	€ 77,00	€ 63,11
T203	Sycion	pag. 450	€ 46,00	€ 37,70
T205	Heraea	pag. 442	€ 117,00	€ 95,90
T206	Heraea	pag. 444	€ 92,00	€ 75,41
T207	Heraea	pag. 446	€ 112,00	€ 91,80
T208	Hermione	pag. 484	€ 42,00	€ 34,43
T209	Hermione	pag. 486	€ 58,00	€ 47,54
T210	Hermione	pag. 488	€ 70,00	€ 57,38
T220.AL...	Chalcis Esterno Aluminium	pag. 47	€ 17,00	€ 13,93
T220.W...	Chalcis Esterno White	pag. 47	€ 17,00	€ 13,93
T221.AL...	Oropus Incasso Aluminium	pag. 39	€ 22,00	€ 18,03

LISTINO PREZZI PER CODICE

Pricelist by code
Preislste nach code
Lista de precios por código
Прайс-лист по кодам

		Catalogo Catalogue Katalog Catálogo Каталог	IVA inclusa Including VAT Inklusive MWST IVA incluido НДС включен	Senza IVA Excluding VAT Ohne MWST IVA excluido Без НДС
T221.W...	Oropus Incasso White	pag. 39	€ 22,00	€ 18,03
T222	Delfi	pag. 466	€ 55,00	€ 45,08
T223	Delfi	pag. 467	€ 72,00	€ 59,02
T224	Delfi	pag. 468	€ 93,00	€ 76,23
T232	Olympia	pag. 170	€ 36,00	€ 29,51
T233	Olympia	pag. 172	€ 83,00	€ 68,03
T235	Olympia	pag. 174	€ 69,00	€ 56,56
T236	Olympia	pag. 176	€ 91,00	€ 74,59
T253	Arta	pag. 456	€ 96,00	€ 78,69
T254	Arta	pag. 458	€ 146,00	€ 119,67
T255	Heraea	pag. 158	€ 83,00	€ 68,03
T256	Heraea	pag. 162	€ 105,00	€ 86,07
T257	Heraea	pag. 166	€ 163,00	€ 133,61
T258	Elide	pag. 428	€ 38,00	€ 31,15
T259	Elide	pag. 430	€ 70,00	€ 57,38
T260	Elide	pag. 432	€ 100,00	€ 81,97
T262	Chio	pag. 354	€ 127,00	€ 104,10
T263	Chio	pag. 356	€ 154,00	€ 126,23
T264	Chio	pag. 358	€ 275,00	€ 225,41
T265	Arta	pag. 452	€ 100,00	€ 81,97
T266	Arta	pag. 454	€ 150,00	€ 122,95
T267	Lepreum	pag. 420	€ 68,00	€ 55,74
T268	Lepreum	pag. 422	€ 99,00	€ 81,15
T269	Paro	pag. 460	€ 99,00	€ 81,15
T270	Paro	pag. 462	€ 165,00	€ 135,25
T271	Heraea	pag. 434	€ 125,00	€ 102,46

		Catalogo Catalogue Katalog Catálogo Каталог	IVA inclusa Including VAT Inklusive MWST IVA incluido НДС включен	Senza IVA Excluding VAT Ohne MWST IVA excluido Без НДС
T273	Heraea	pag. 436	€ 155,00	€ 127,05
T274	Chio	pag. 350	€ 47,00	€ 38,52
T278	Chio	pag. 352	€ 88,00	€ 72,13
T287	Lepreum	pag. 424	€ 167,00	€ 136,89
T291	Side	pag. 382	€ 70,00	€ 57,38
T292	Side	pag. 384	€ 127,00	€ 104,10
T293	Side	pag. 386	€ 172,00	€ 140,98
T294	Mylasa	pag. 408	€ 39,00	€ 31,97
T295	Mylasa	pag. 410	€ 67,00	€ 54,92
T296	Mylasa	pag. 412	€ 95,00	€ 77,87
T303	Lepreum	pag. 426	€ 221,00	€ 181,15
T309.AL....	Methoni Aluminium	pag. 51	€ 20,00	€ 16,39
T310.AL...	Icus Esterno Aluminium	pag. 55	€ 16,00	€ 13,11
T311.10	Pirgos	pag. 62	€ 272,00	€ 222,95
T311.10 D	Pirgos	pag. 62	€ 347,00	€ 284,43
T311.11	Pirgos	pag. 62	€ 356,00	€ 291,80
T311.11 D	Pirgos	pag. 62	€ 431,00	€ 353,28
T311.30	Pirgos	pag. 66	€ 323,00	€ 264,75
T311.30 D	Pirgos	pag. 66	€ 398,00	€ 326,23
T311.31	Pirgos	pag. 66	€ 408,00	€ 334,43
T311.31 D	Pirgos	pag. 66	€ 483,00	€ 395,90
T311.50	Pirgos	pag. 70	€ 569,00	€ 466,39
T312	Tenedos	pag. 414	€ 40,00	€ 32,79
T313	Tenedos	pag. 416	€ 80,00	€ 65,57
T314	Tenedos	pag. 418	€ 119,00	€ 97,54
T319	Chio	pag. 364	€ 52,00	€ 42,62

LISTINO PREZZI PER CODICE

Pricelist by code
Preislste nach code
Lista de precios por código
Прайс-лист по кодам

		Catalogo Catalogue Katalog Catálogo Каталог	IVA inclusa Including VAT Inklusive MWST IVA incluido НДС включен	Senza IVA Excluding VAT Ohne MWST IVA excluido Без НДС
T320	Chio	pag. 368	€ 96,00	€ 78,69
T321	Chio	pag. 372	€ 96,00	€ 78,69
T322	Chio	pag. 376	€ 146,00	€ 119,67
T323	Side	pag. 392	€ 57,00	€ 46,72
T324	Side	pag. 396	€ 104,00	€ 85,25
T325	Side	pag. 400	€ 96,00	€ 78,69
T326	Side	pag. 404	€ 152,00	€ 124,59
T332	Thessaly	pag. 126	€ 26,00	€ 21,31
T334	Thessaly	pag. 130	€ 26,00	€ 21,31
T335	Thessaly	pag. 134	€ 26,00	€ 21,31
T336	Thessaly	pag. 138	€ 26,00	€ 21,31
T337	Filiatrá	pag. 80	€ 19,00	€ 15,57
T338	Filiatrá	pag. 84	€ 25,00	€ 20,49
T339	Demetra	pag. 280	€ 35,00	€ 28,69
T353	Doride	pag. 150	€ 31,00	€ 25,41
T354	Doride	pag. 154	€ 33,00	€ 27,05
T356	Lelanto	pag. 142	€ 31,00	€ 25,41
T357	Lelanto	pag. 146	€ 61,00	€ 50,00
T358	Demetra	pag. 284	€ 57,00	€ 46,72
T359	Demetra	pag. 288	€ 80,00	€ 65,57
T360	Demetra	pag. 296	€ 46,00	€ 37,70
T361	Demetra	pag. 300	€ 66,00	€ 54,10
T362	Demetra	pag. 304	€ 66,00	€ 54,10
T371	Anchise	pag. 330	€ 35,00	€ 28,69
T372	Anchise	pag. 334	€ 60,00	€ 49,18
T373	Anchise	pag. 338	€ 88,00	€ 72,13

		Catalogo Catalogue Katalog Catálogo Каталог	IVA inclusa Including VAT Inklusive MWST IVA incluido НДС включен	Senza IVA Excluding VAT Ohne MWST IVA excluido Без НДС
T374	Anchise	pag. 342	€ 42,00	€ 34,43
T375	Anchise	pag. 346	€ 63,00	€ 51,64
T377	Sibari	pag. 310	€ 50,00	€ 40,98
T378	Sibari	pag. 314	€ 75,00	€ 61,48
T379	Sibari	pag. 318	€ 42,00	€ 34,43
T380	Sibari	pag. 322	€ 62,00	€ 50,82
T381	Filiatrá	pag. 92	€ 26,00	€ 21,31
T382	Filiatrá	pag. 96	€ 33,00	€ 27,05
T383	Filiatrá	pag. 100	€ 27,00	€ 22,13
T384	Phocis	pag. 104	€ 31,00	€ 25,41
T385	Cicladi	pag. 240	€ 51,00	€ 41,80
T386	Cicladi	pag. 244	€ 95,00	€ 77,87
T387	Cicladi	pag. 224	€ 50,00	€ 40,98
T388	Cicladi	pag. 228	€ 93,00	€ 76,23
T389	Cicladi	pag. 232	€ 134,00	€ 109,84
T390	Thessaly	pag. 110	€ 26,00	€ 21,31
T391	Thessaly	pag. 114	€ 26,00	€ 21,31
T392	Thessaly	pag. 118	€ 26,00	€ 21,31
T393	Thessaly	pag. 122	€ 26,00	€ 21,31
T394	Patra	pag. 212	€ 33,00	€ 27,05
T395	Patra	pag. 216	€ 57,00	€ 46,72
T396	Cicladi	pag. 248	€ 95,00	€ 77,87
T397.1M.3000	Strip Led 3000°K	pag. 31	€ 18,00	€ 14,75
T397.2M.3000	Strip Led 3000°K	pag. 31	€ 35,00	€ 28,69
T397.3M.3000	Strip Led 3000°K	pag. 31	€ 52,00	€ 42,62
T397.4M.3000	Strip Led 3000°K	pag. 31	€ 69,00	€ 56,56

LISTINO PREZZI PER CODICE

Pricelist by code
 Preisliste nach code
 Lista de precios por código
 Прайс-лист по кодам

		Catalogo Catalogue Katalog Catálogo Каталог	IVA inclusa Including VAT Inklusive MWST IVA incluido НДС включен	Senza IVA Excluding VAT Ohne MWST IVA excluido Без НДС
T397.5M.3000	Strip Led 3000°K	pag. 31	€ 86,00	€ 70,49
T397.1M.4000	Strip Led 4000°K	pag. 31	€ 18,00	€ 14,75
T397.2M.4000	Strip Led 4000°K	pag. 31	€ 35,00	€ 28,69
T397.3M.4000	Strip Led 4000°K	pag. 31	€ 52,00	€ 42,62
T397.4M.4000	Strip Led 4000°K	pag. 31	€ 69,00	€ 56,56
T397.5M.4000	Strip Led 4000°K	pag. 31	€ 86,00	€ 70,49
T398.1M.3000	Strip Led 3000°K	pag. 31	€ 23,00	€ 18,85
T398.2M.3000	Strip Led 3000°K	pag. 31	€ 46,00	€ 37,70
T398.3M.3000	Strip Led 3000°K	pag. 31	€ 69,00	€ 56,56
T398.4M.3000	Strip Led 3000°K	pag. 31	€ 92,00	€ 75,41
T398.5M.3000	Strip Led 3000°K	pag. 31	€ 114,00	€ 93,44
T398.1M.4000	Strip Led 4000°K	pag. 31	€ 23,00	€ 18,85
T398.2M.4000	Strip Led 4000°K	pag. 31	€ 46,00	€ 37,70
T398.3M.4000	Strip Led 4000°K	pag. 31	€ 69,00	€ 56,56
T398.4M.4000	Strip Led 4000°K	pag. 31	€ 92,00	€ 75,41
T398.5M.4000	Strip Led 4000°K	pag. 31	€ 114,00	€ 93,44
T399	Pitane	pag. 268	€ 48,00	€ 39,34
T400	Pitane	pag. 272	€ 89,00	€ 72,95
T401	Pitane	pag. 256	€ 89,00	€ 72,95
T402	Pitane	pag. 260	€ 123,00	€ 100,82

TECNICO[®]
 N A T U R A L L I G H T

Viale dell'Industria, 21
20037 Paderno Dugnano (MI) - Italy
Tel. +39 02 9104958 r.a. - +39 02 9105178
Fax +39 02 9185542
info@sforzinilluminazione.com
www.sforzinilluminazione.com

La tassa sullo smaltimento dei rifiuti degli apparecchi di illuminazione non è inclusa nel presente listino e viene versata al Consorzio Ecolight.
The lighting equipment waste disposal tax is not included in this price list and is paid to the Ecolight consortium.
Die Steuer zur Entsorgung von aus Beleuchtungen entstehender Abfälle ist in dieser Preislite nicht eingeschlossen und wird an das Konsortium Ecolight entrichtet.
El impuesto de eliminación de residuos de aparatos de iluminación no está incluido en la presente lista de precios y se ingresa al Consorzio Ecolight.
Сбор за переработку отходов осветительных приборов не включен в данном прайс-листе. Он оплачивается Консорциуму Ecolight.

February 2022

Thanks to:

Concept & Development: red-apple.it

Art direction: _blank design studio

Photo: Paolo Volontè

