



- Euclide _____
- Filo _____
- Cartesian _____
- Eg _____
- Anello _____
- Aki _____
- Olo _____
- Linea _____
- Lamoi _____
- Lamoi 2.0 _____
- Tesa _____
- Tesa 2.0 _____
- Lafra _____
- Lafra 2.0 _____
- Beba _____

URBAN[®]
IDEE CHE DIVENTANO LUCE

U14

URBAN[®]
IDEE CHE DIVENTANO LUCE

Index

AKI	132
TECHNICAL DATA	147
PRICE LIST	330
ANELLO	96
TECHNICAL DATA	109-121-131
PRICE LIST	324
BEBA	294
TECHNICAL DATA	313
PRICE LIST	358
CARTESIAN	66
TECHNICAL DATA	76-78-84
PRICE LIST	321
EG	86
TECHNICAL DATA	95
PRICE LIST	323
EUCLIDE	10
TECHNICAL DATA	23-33-39-43
PRICE LIST	316
FILO	44
TECHNICAL DATA	57-65
PRICE LIST	319
LAFRA	270
TECHNICAL DATA	283-293
PRICE LIST	354
LAFRA 2.0	278
TECHNICAL DATA	283-293
PRICE LIST	356
LAMOI	200
TECHNICAL DATA	215
PRICE LIST	346
LAMOI 2.0	208
TECHNICAL DATA	215
PRICE LIST	350
LINEA	164
TECHNICAL DATA	174-184-188-196-198
PRICE LIST	334
OLO	148
TECHNICAL DATA	163
PRICE LIST	332
TESA	232
TECHNICAL DATA	241-253
PRICE LIST	352
TESA 2.0	254
TECHNICAL DATA	263-269
PRICE LIST	353

TABLE OF CONTENT BY TYPE

INDICE PER TIPOLOGIA / INHALT NACH TYPOLOGIE / ÍNDICE POR TIPO / СПИСОК ПО ТИПОЛОГИИ

SUSPENSION

Lampade a sospensione
Pendelleuchte
Lámparas colgantes
Подвесные светильники

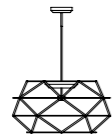

EUCLIDE
1821-1822



p 10 / 23



FILO
1839-1840



p 44 / 57

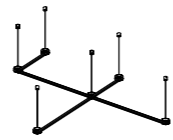

CARTESIAN
1832



p 80 / 85

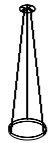

ANELLO
1790-1799
1800-1801



p 110 / 121

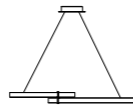

ANELLO
1790-1799
1800-1801



p 122 / 131



LINEA
1795



p 164 / 175

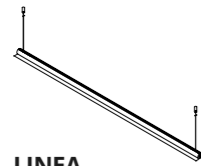

LINEA
1795



p 190 / 199

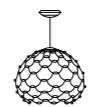

LAMOI
1812-1816-1817



p 200 / 207

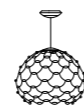

LAMOI 2.0
1831



p 208 / 215



TESA
1836-1937



p 232 / 241



TESA 2.0
1838



p 254 / 263



BEBA
1730



p 294 / 313

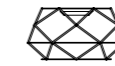

EUCLIDE
1821-1822



p 24 / 33



FILO
1839-1840



p 58 / 65

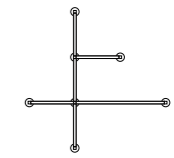

CARTESIAN
1832



p 66 / 79



EG
1828-1829-1830



p 86 / 95



ANELLO
1790-1799
1800-1801



p 96 / 109



LINEA
1795



p 180 / 185



TESA
1836-1937



p 242 / 253



TESA 2.0
1838



p 264 / 269



LAMOI
1812-1816-1817



p 216 / 219



LAMOI 2.0
1831



p 220 / 227



LAFRA
1834



p 270 / 279



LAFRA 2.0
1834



p 280 / 283

TABLE OF CONTENT BY TYPE

INDICE PER TIPOLOGIA / INHALT NACH TYPOLOGIE / ÍNDICE POR TIPO / СПИСОК ПО ТИПОЛОГИИ

WALL
Lampade da parete
Wandleuchte
Lámparas de pared
Настенные светильники



EUCLIDE
1821-1822



p 34 / 39

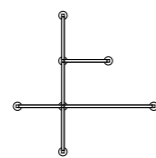

CARTESIAN
1832



p 66 / 79



AKI
1796-1797-1798
1823-1835



p 132 / 147



OLO
1776-1791-1792
1793-1824



p 148 / 163



LINEA
1795



p 176 / 179



LAFRA
1833



p 284 / 287



LAFRA 2.0
1834



p 288 / 293



EUCLIDE
1821-1822



p 40 / 43



LINEA
1795



p 186 / 189



LAMOI
1812-1816-1817



p 228 / 231

FLOOR
Lampade da terra
Stehleuchten
Lámparas de pie
Напольные светильники

TABLE OF CONTENTS BY CODE

INDICE PER CODICE / INHALT NACH ARTIKELNUMMER / ÍNDICE POR REFERENCIA / СПИСОК ПО КОДУ

CODE	ART.	PAG.
1730	BEBA	294
1776	OLO	152
1790	ANELLO	97-110-122
1791	OLO	154
1792	OLO	156
1793	OLO	158
1795	LINEA	165
1796	AKI	136
1797	AKI	138
1798	AKI	142
1799	ANELLO	100-114-128
1800	ANELLO	104-116-127
1801	ANELLO	106-118-126
1810	LINEA	186
1811	LINEA	188
1812	LAMOI	202-216
1816	LAMOI	201-206
1817	LAMOI	206-217-230
1821	EUCLIDE	11-24-34-40
1822	EUCLIDE	16-28-36-41
1823	AKI	144
1824	OLO	160
1828	EG	88
1829	EG	90
1830	EG	92
1831	LAMOI 2.0	208-220
1832	CARTESIAN	80
1833	LAFRA	270-284
1834	LAFRA 2.0	278-288
1835	AKI	140
1836	TESA	236-248
1837	TESA	232-242
1838	TESA 2.0	254-264
1839	FILO	52-62
1840	FILO	45-58

DESIGNERS

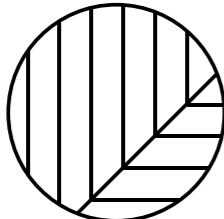

Acero.

Acero Design Studio



Andrea Barra



_blank design studio



Extravergine



Gerardo Mari



Marco Spatti

EUCLIDE

Gerardo Mari

EUCLIDE

Impalpable form of living light.
This family of lamps consists of geometric structures formed by the light source.
Impalpable, almost ethereal, shapes materialise with light.
The light sources make up the structure and define the volume.
The effect is pure light magic.
The structure contains the LED power cables.
Euclide is eco-friendly, with minimum power and matter requirements for its construction.

EUCLIDE

Impalpabile forma di luce viva. Questa famiglia di lampade è composta da strutture geometriche costituite dalla sorgente luminosa stessa. Impalpabili quasi eteree, le forme si materializzano con la luce, sono le sorgenti luminose a comporre la struttura e definire il volume. L'effetto è magia di pura luce. La corrente per alimentare i Led passa attraverso la struttura. Euclide è eco friendly, utilizza il minimo di energia e di materia per la realizzazione.

EUCLIDE

Ungreifbare Form des lebendigen Lichts. Diese Lampenfamilie besteht aus geometrischen Strukturen, die von der Lichtquelle selbst gebildet werden. Unmerklich, fast ätherisch, Die Formen materialisieren sich durch das Licht, die Lichtquellen sind es, die die Struktur bilden und das Volumen definieren. Der Effekt ist pure Lichtmagie. Der Strom zur Versorgung der LEDs durchläuft die Struktur. Euclide ist umweltfreundlich und verwendet das Minimum von Energie und Materie zur Realisierung.

EUCLIDE

Forma impalpable de luz viva. Esta familia de lámparas se compone de estructuras geométricas formadas por la propia fuente de luz. Impalpables, casi etéreas, las formas se materializan con la luz, son las fuentes de luz las que componen la estructura y definen el volumen. El efecto es pura magia luminosa. La corriente para alimentar los LED atraviesa la estructura. Euclide es respetuoso con el medio ambiente y utiliza el mínimo de energía y materia para su realización.

EUCLIDE

Неосязаемая форма живого света. Светильники этой серии представляют собой геометрические конструкции, являющиеся одновременно и источником света. Невесомые, почти эфирные формы материализуются благодаря свету, ведь именно источники света задают структуру и определяют объем. В итоге рождается магия чистого света. Питающий светодиоды ток проходит через каркас. Euclide - это экологически чистое изделие, потребляющее минимум энергии; кроме того, при его изготовлении было израсходовано минимальное количество сырья.



EUCLIDE SUSPENSION



EUCLIDE SUSPENSION



EUCLIDE SUSPENSION





EUCLIDE SUSPENSION



EUCLIDE SUSPENSION



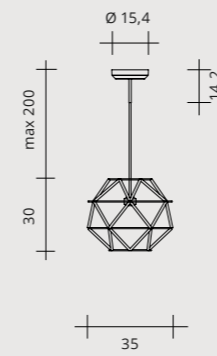

LED 44W - 24V
2700°K / 2945 lumen
3000°K / 3273 lumen

Versions:

On-Off

Push

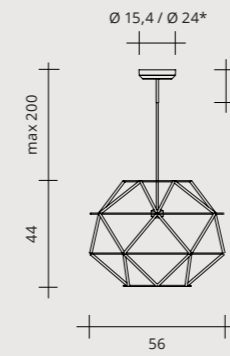

LED 62W - 24V
2700°K / 4593 lumen
3000°K / 5104 lumen

Versions:

On-Off

Push

Dali

0-10v

1-10v

Triac

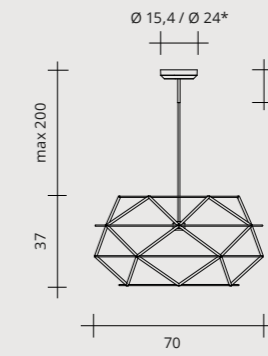

LED 62W - 24V
2700°K / 4805 lumen
3000°K / 5339 lumen

Versions:

On-Off

Push

Dali

0-10v

1-10v

Triac

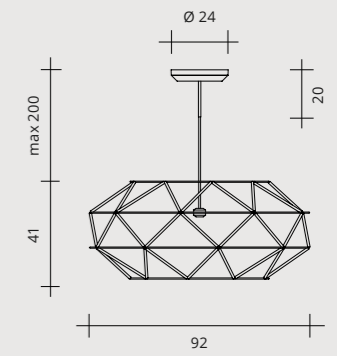

LED 92W - 24V
2700°K / 7130 lumen
3000°K / 7922 lumen

Versions:

On-Off

Push

Dali

0-10v

1-10v

Triac

EUCLIDE Suspension

Lampada a sospensione

Pendelleuchte

Lámpara colgante

Подвесная лампа



FINISHES / FINITURE / FARBE / ACABADOS / ОТДЕЛКИ

● Matt black / Nero opaco / Mattschwarz / Negro mate / Матовый черный

● Gold / Oro / Kupfe / Gold / Золото

EUCLIDE CEILING





EUCLIDE CEILING

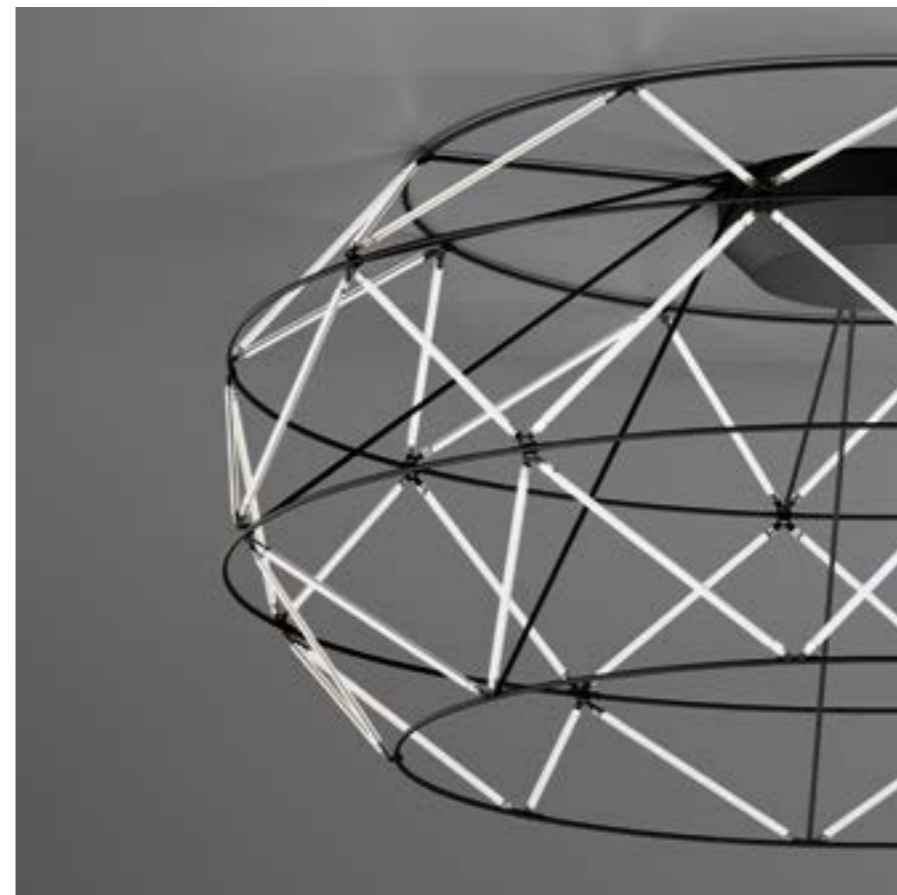

EUCLIDE CEILING





EUCLIDE CEILING



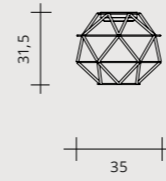

LED 44W - 24V
2700°K / 2945 lumen
3000°K / 3273 lumen

Versions:

On-Off

Push

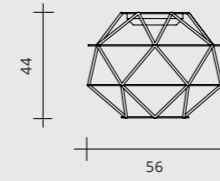

LED 62W - 24V
2700°K / 4593 lumen
3000°K / 5104 lumen

Versions:

On-Off

Push
Dali
0-10v
1-10v

Triac

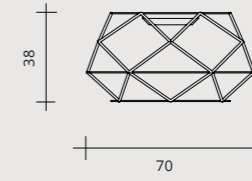

LED 62W - 24V
2700°K / 4805 lumen
3000°K / 5339 lumen

Versions:

On-Off

Push
Dali
0-10v
1-10v

Triac

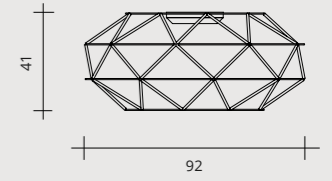

LED 92W - 24V
2700°K / 7130 lumen
3000°K / 7922 lumen

Versions:

On-Off

Push
Dali
0-10v
1-10v

Triac

EUCLIDE Ceiling

Lampada da soffitto
Deckenleuchte
Lámpara de techo
Потолочная лампа



FINISHES / FINITURE / FARBE / ACABADOS / ОТДЕЛКИ

● Matt black / Nero opaco / Mattschwarz / Negro mate / Матовый черный цвет

● Gold / Oro / Kupfe / Gold / Золото

EUCLIDE WALL

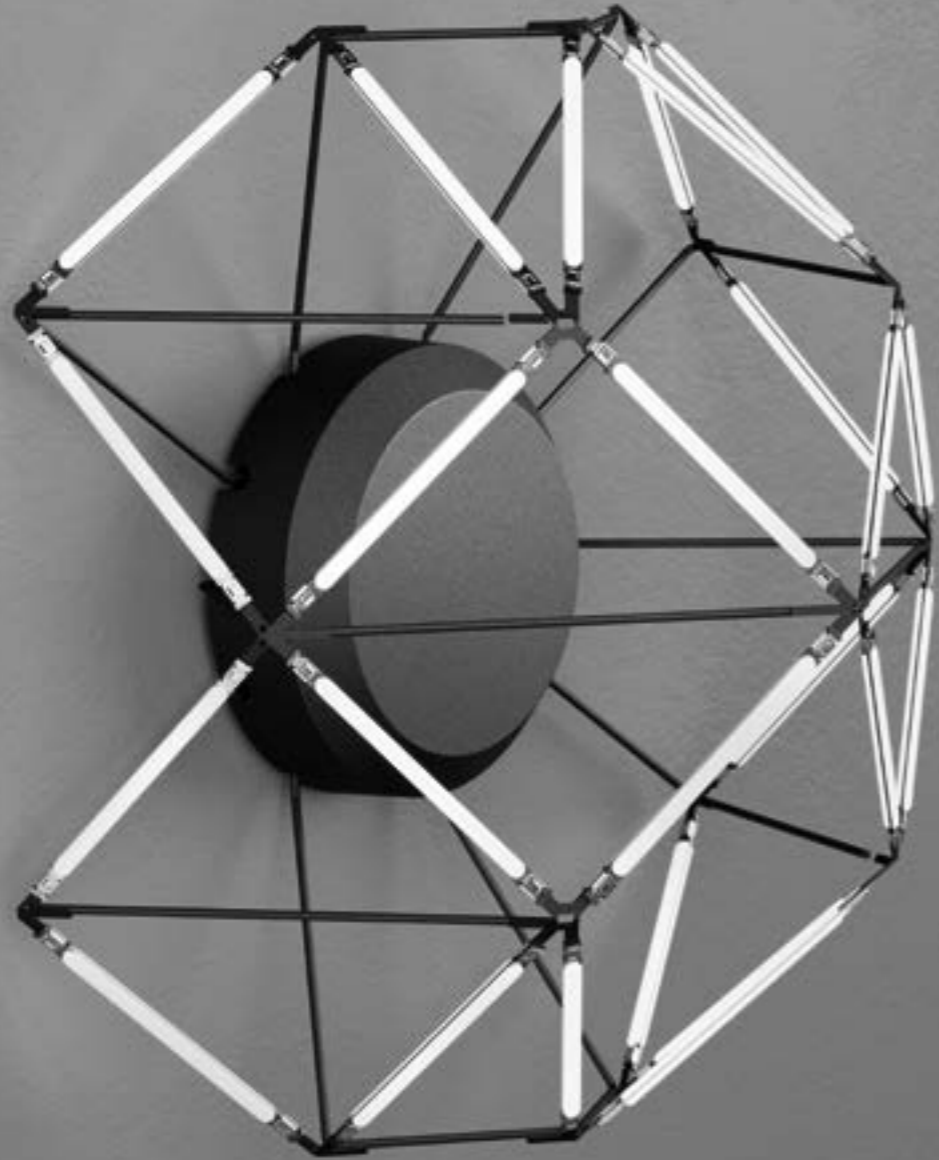

EUCLIDE WALL

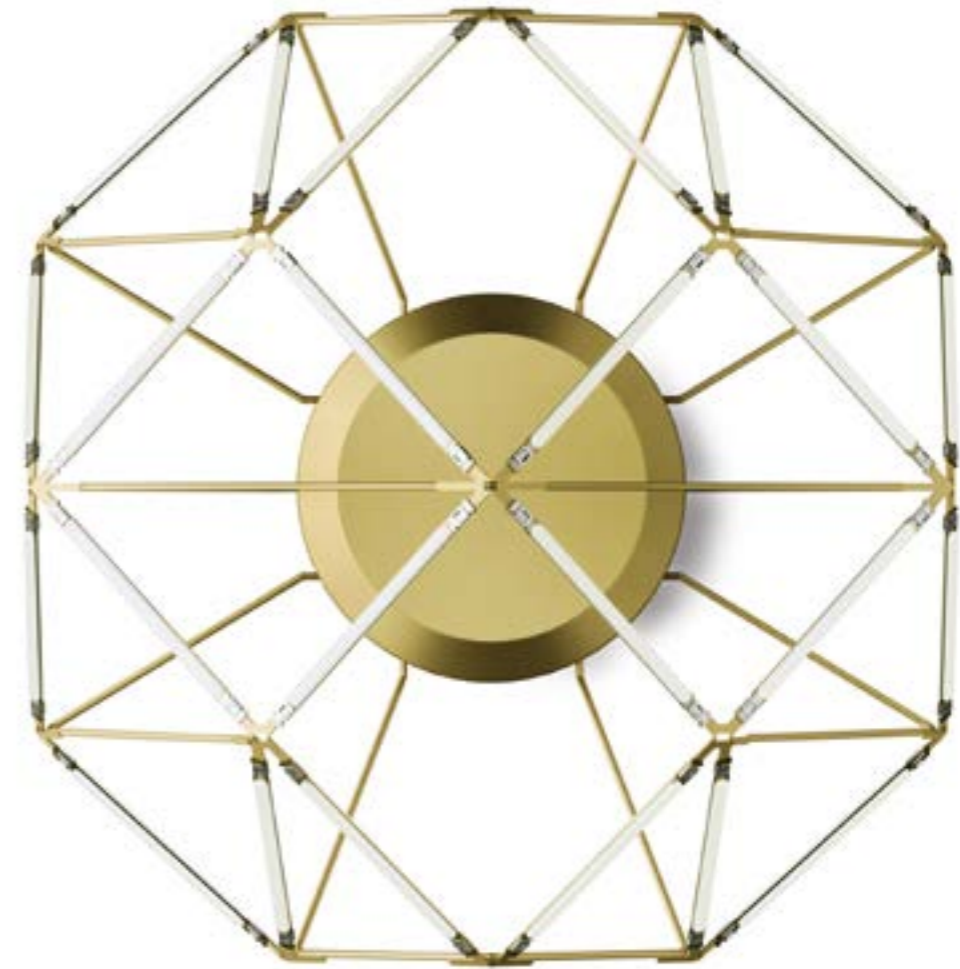

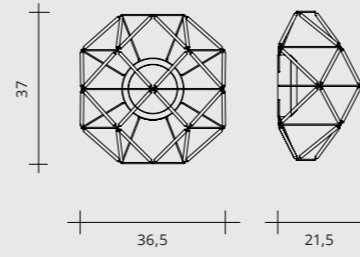

LED 29W - 24V
2700°K / 1963 lumen
3000°K / 2181 lumen

Version:

On-Off

EUCLIDE Wall

Lampada da parete
Wandleuchte
Lámpara de pared
Настенная лампа



FINISHES / FINITURE / FARBE / ACABADOS / ОТДЕЛКИ

- Matt black / Nero opaco / Mattschwarz / Negro mate / Матовый черный/вет
- Gold / Oro / Kupfe / Gold / Золото



EUCLIDE FLOOR



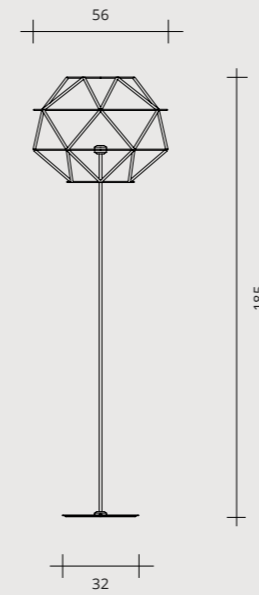

LED 62W - 24V
2700°K / 4593 lumen
3000°K / 5104 lumen

*Footswitch dimmer included.
Dimmer a pedale incluso.
Inklusive Fußschalter und Dimmer.
Regulador de intensidad con pedal incluido.
В комплект входит диммер с ножным управлением.*

EUCLIDE **Floor**

*Lampada da terra.
Stehleuchte.
Lámpara de pie.
Напольная лампа.*



FINISHES / FINITURE / FARBE / ACABADOS / ОТДЕЛКИ

- Matt black / Nero opaco / Mattschwarz / Negro mate / Матовый черный цвет
- Gold / Oro / Kupfe / Gold / Золото

FILO

Marco Spatti

FILO

Under a new light.
The architecture of this product is characterised by the repetition of graphic signs around the central fulcrum. A sensual narrative through lines of light whose rhythm draws shapes in space, generates volumes permeable to the eye with lightness, elegance and style. An understated design that creates a luminous setting and enhances architectural spaces. A lighting concept whose identity was gained from the combination of memory and contemporary, to create hybrid and transverse non-chronological emotions.

FILO

Sotto un'altra luce. L'architettura del prodotto è caratterizzata dalla ripetizione di segni grafici intorno al fulcro centrale. Una narrazione sensuale attraverso linee di luce il cui ritmo disegna forme nello spazio, genera volumi permeabili alla vista con leggerezza, eleganza e stile. Un design sobrio che crea scenografia luminosa e valorizza gli spazi architettonici. Un concetto di illuminazione che ha una identità acquisita dalla combinazione di memoria e contemporaneo per creare emozioni ibride e trasversali non cronologiche.

FILO

In einem anderen Licht. Die Architektur des Produkts ist durch die Wiederholung der grafischen Zeichen um den zentralen Drehpunkt gekennzeichnet. Eine sinnliche Erzählung durch Lichtlinien, deren Rhythmus Formen in den Raum zeichnet, erzeugt Volumen, die mit Leichtigkeit, Eleganz und Stil für das Auge durchlässig sind. Ein unaufdringliches Design, das eine leuchtende Umgebung schafft und architektonische Räume aufwertet. Ein Beleuchtungskonzept, das eine Identität hat, die aus der Kombination von Erinnerung und Zeitgenössischem entsteht, um hybride und transversale nicht-chronologische Emotionen zu schaffen.

FILO

Desde otro punto de luz. La arquitectura del producto se caracteriza por la repetición de signos gráficos en torno al fulcro central. Una narrativa sensual a través de líneas de luz cuyo ritmo dibuja formas en el espacio, genera volúmenes permeables a la vista con ligereza, elegancia y estilo. Un diseño discreto que crea un entorno luminoso y realza los espacios arquitectónicos. Un concepto de iluminación que tiene una identidad que nace de la combinación de la memoria y lo contemporáneo para crear emociones híbridas y transversales no cronológicas.

FILO

В ином свете. Дизайн изделия основан на повторяющихся графических знаках, кольцом охватывающих центральную часть. Чувственный образ, сотканный из световых контуров, чей ритм создает в пространстве формы и прозрачные объемы под знаком легкости, элегантности и стиля. Сдержанный дизайн, создающий атмосферу, полную света, и выгодно подчеркивающий интерьерное пространство. Концепция освещения, имеющая собственный неповторимый облик, который складывается из сочетания винтажных и современных элементов, создавая многогранные, «сквозные», вневременные эмоции.





FILO SUSPENSION

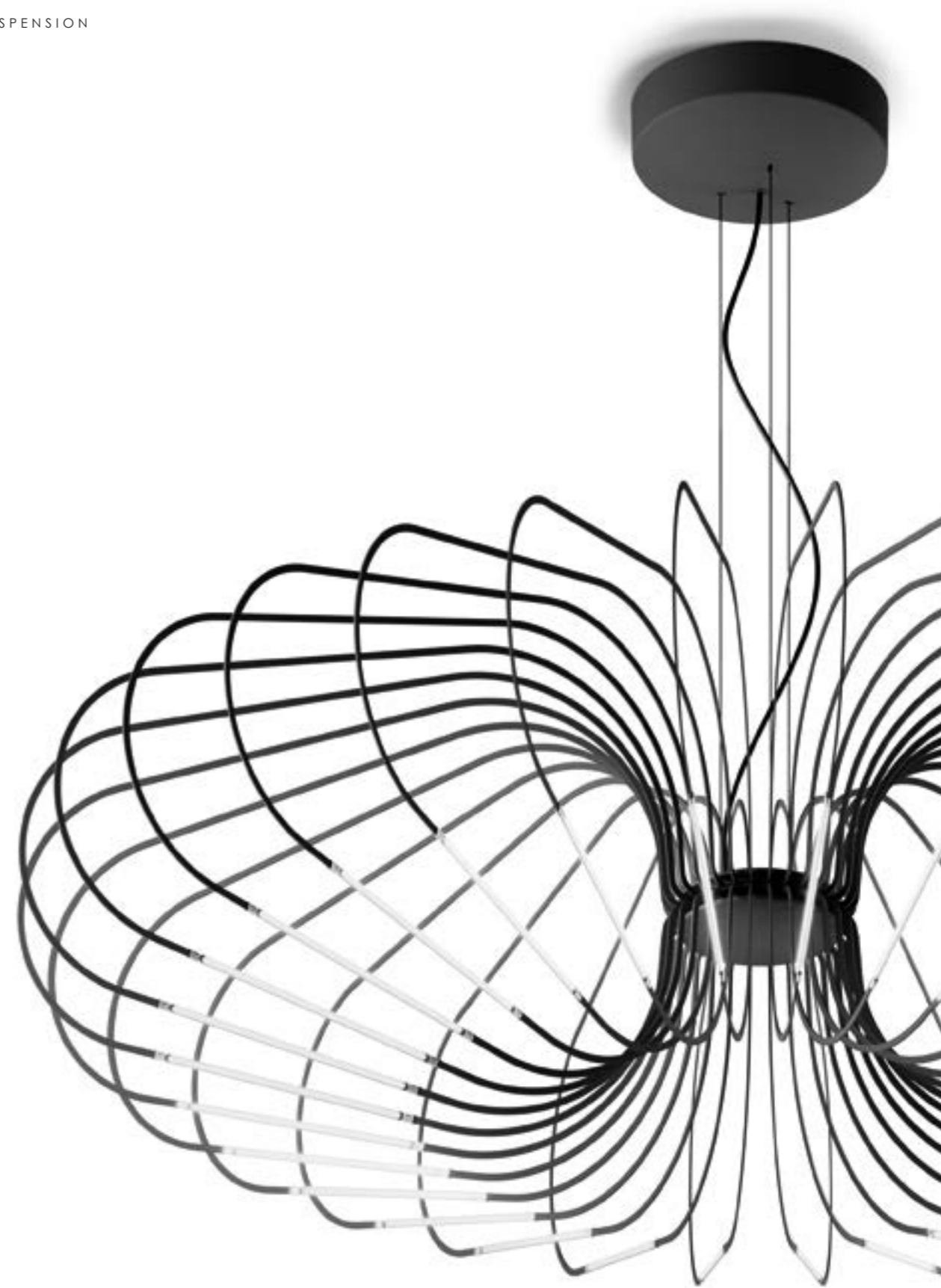

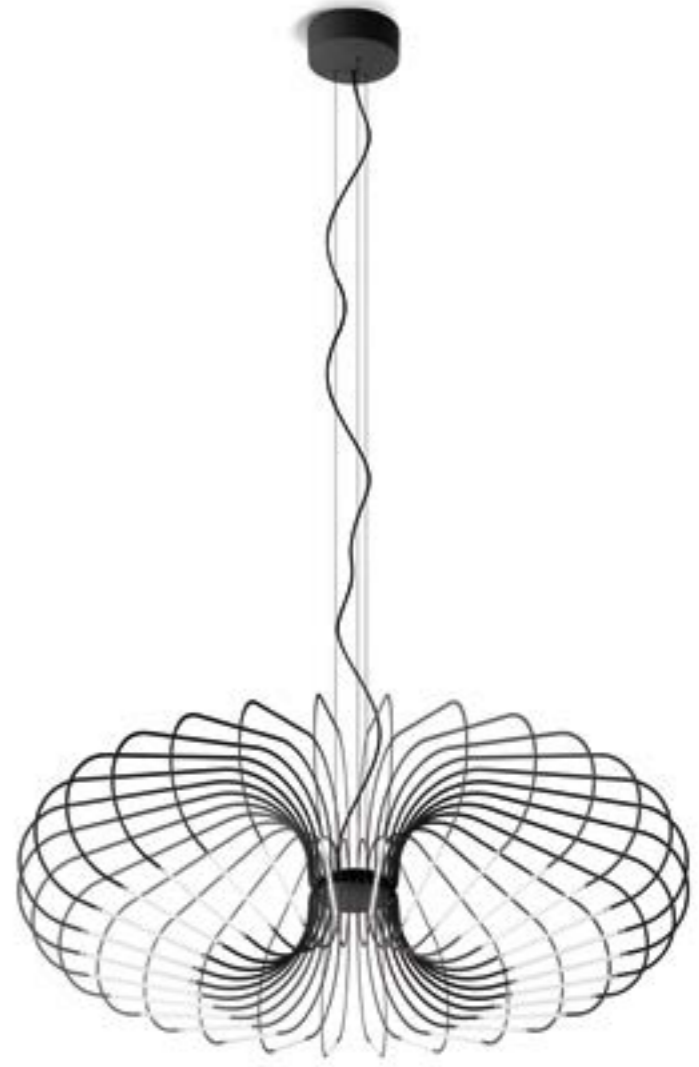
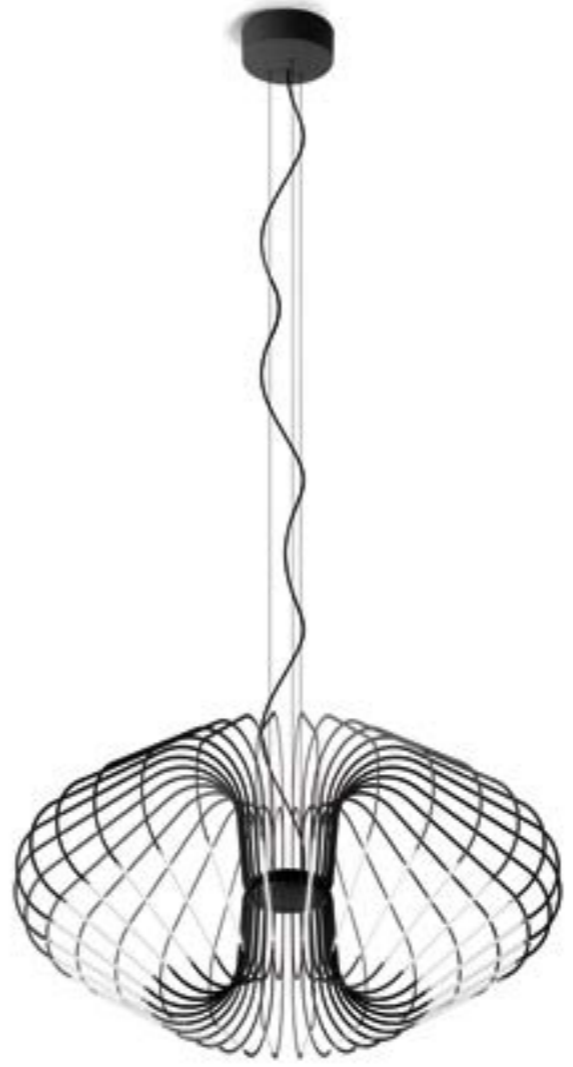
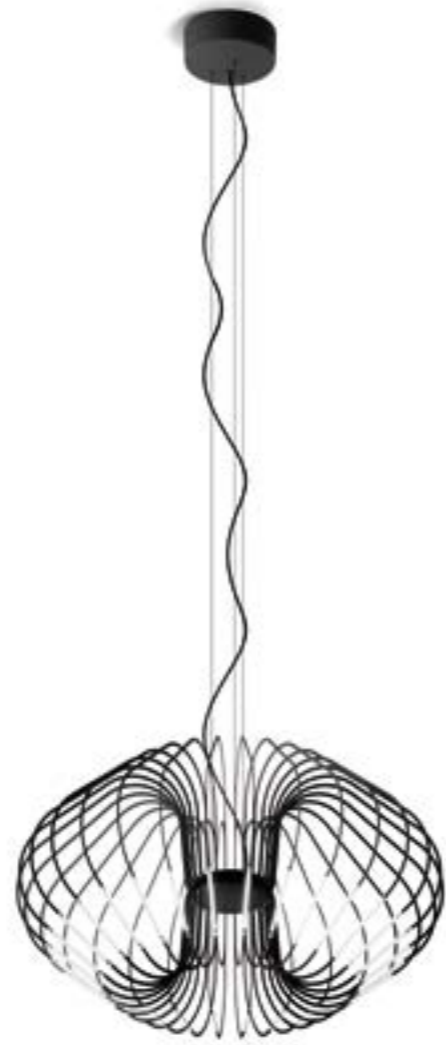
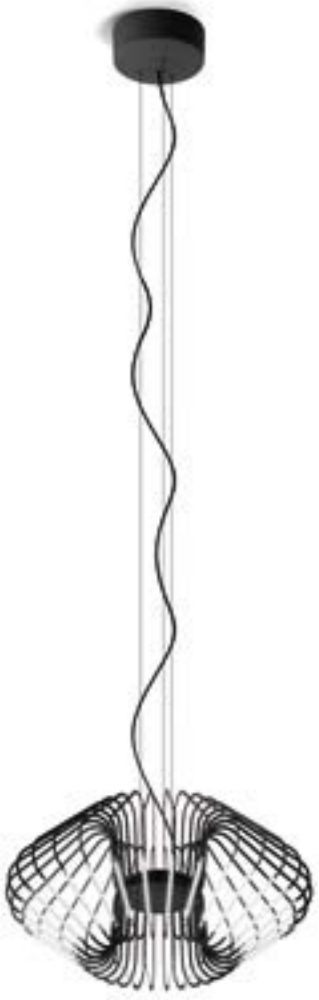



FILO SUSPENSION

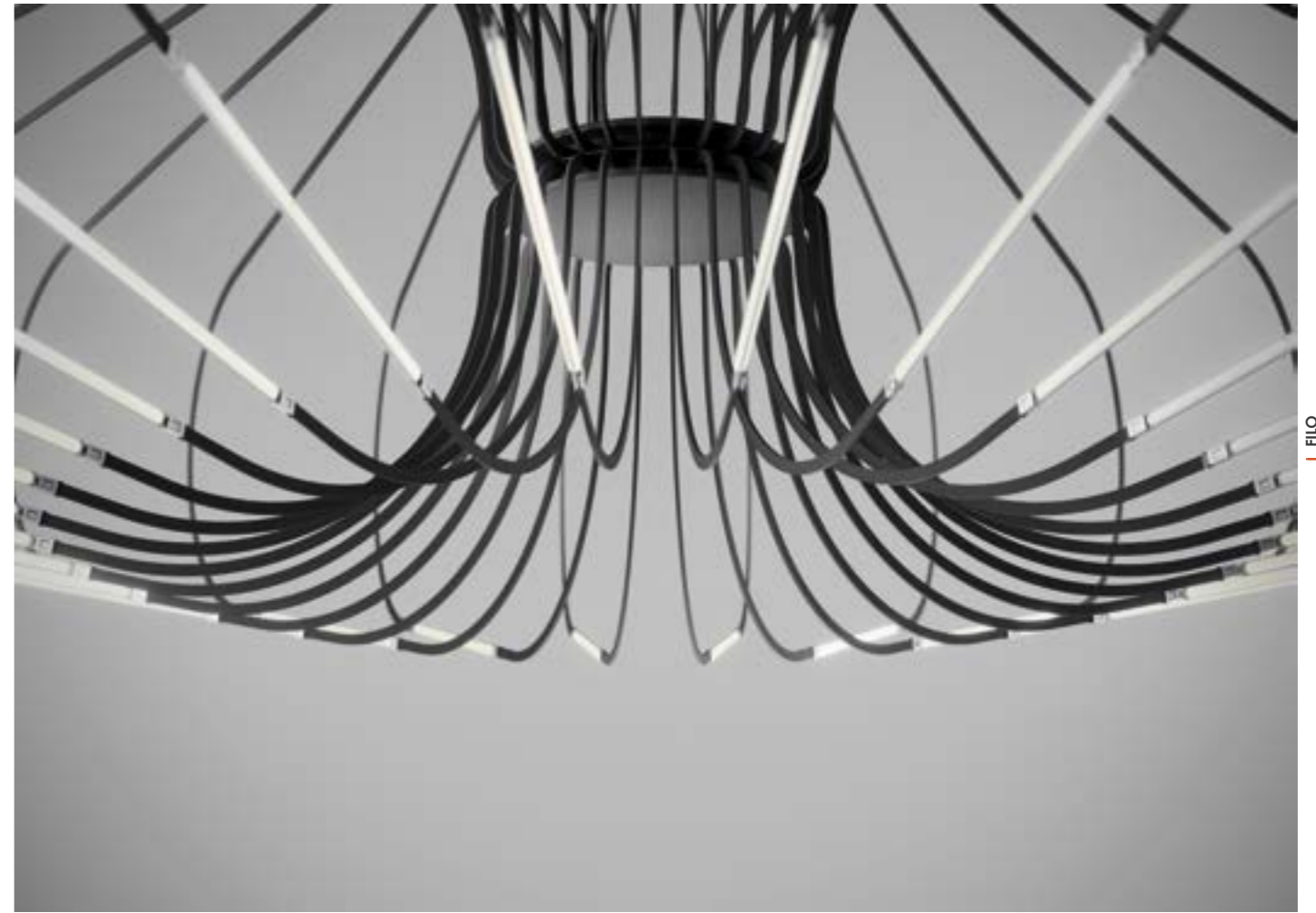

FILO SUSPENSION



FILO SUSPENSION



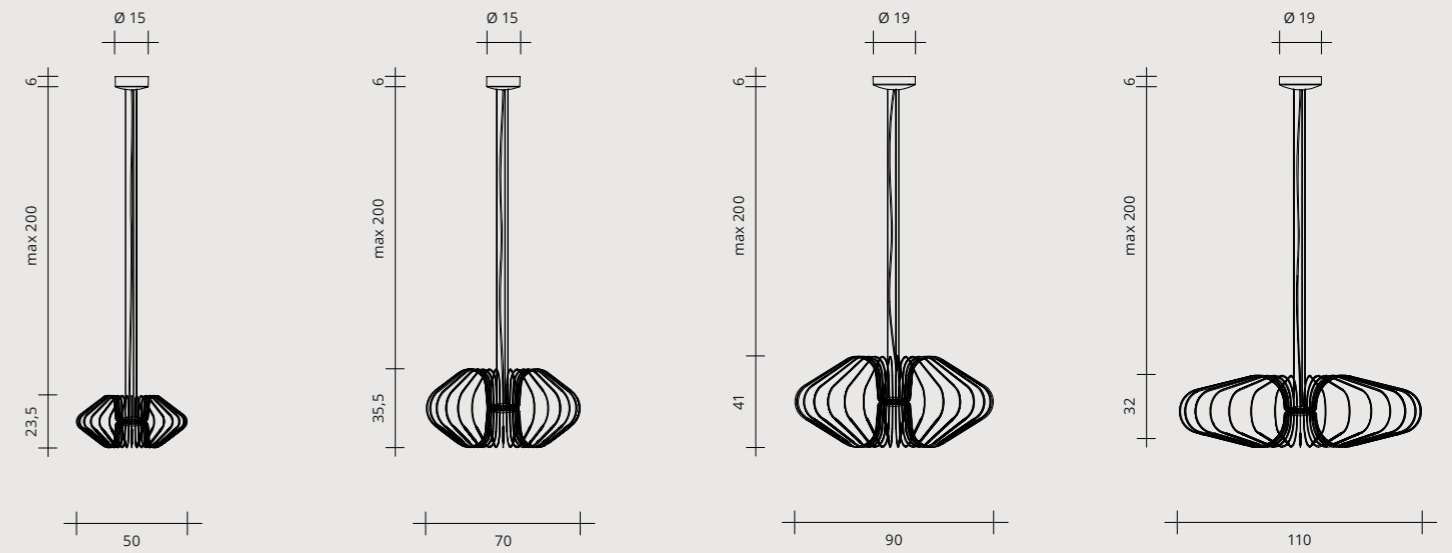

LED 36W - 24V
2700°K / 2460 lumen
3000°K / 2750 lumen

Versions:

On-Off

Push
Dali
0-10v
1-10v

LED 36W - 24V
2700°K / 2460 lumen
3000°K / 2750 lumen

Versions:

On-Off

Push
Dali
0-10v
1-10v

LED 51W - 24V
2700°K / 4568 lumen
3000°K / 5076 lumen

Versions:

On-Off

Push
Dali
0-10v
1-10v

Triac

LED 51W - 24V
2700°K / 4568 lumen
3000°K / 5076 lumen

Versions:

On-Off

Push
Dali
0-10v
1-10v

Triac

FILO Suspension

Lampada a sospensione
Pendelleuchte
Lámpara colgante
Подвесная лампа



FINISHES / FINITURE / FARBE / ACABADOS / ОТДЕЛКИ

- Matt powder pink / Cipria opaco / Puderfarben matt / Rosa palo mate / Пудровый матовый
- Titanium / Titanio / Titan / Titanio / Титан



FILO CEILING

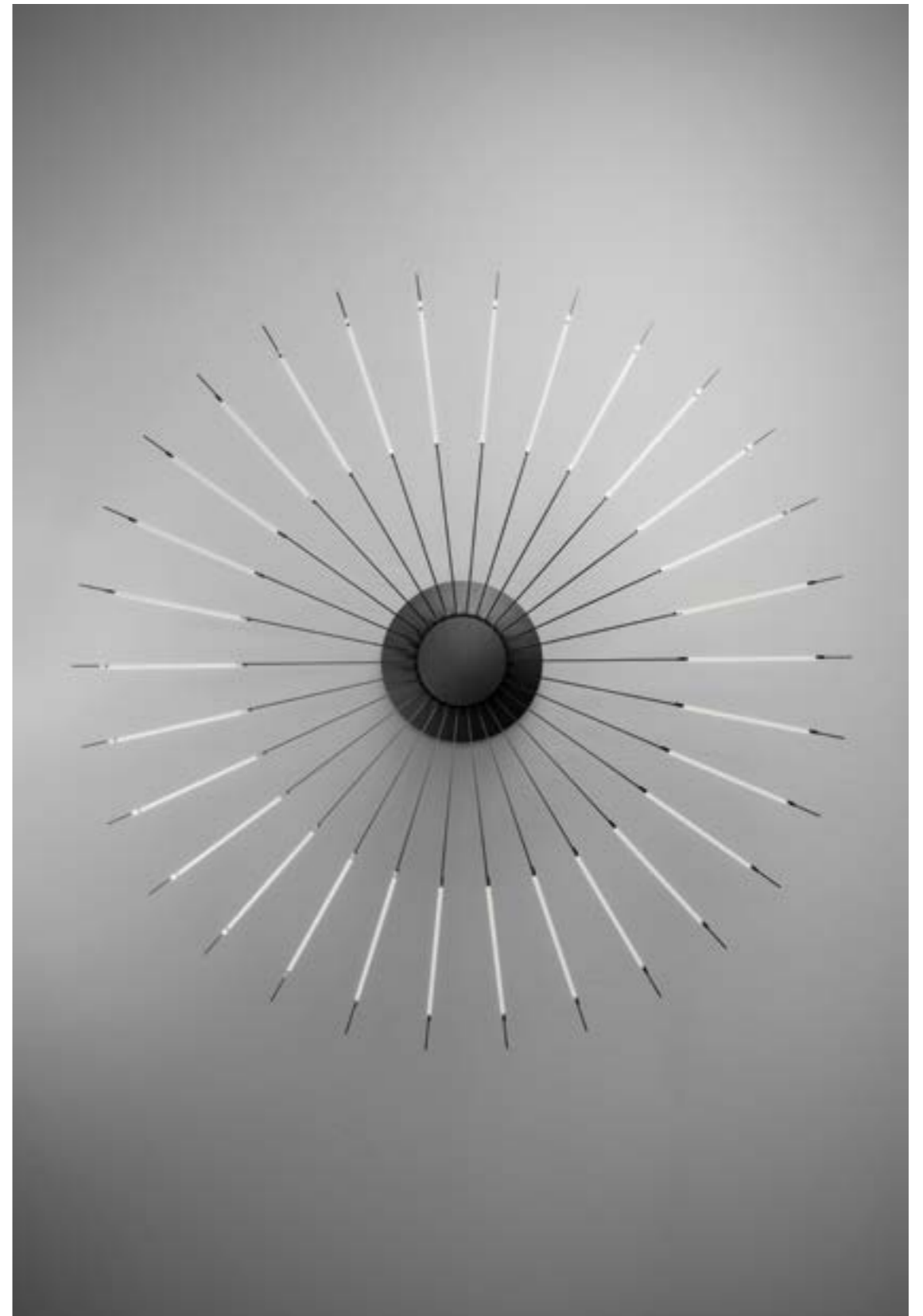

FILO CEILING

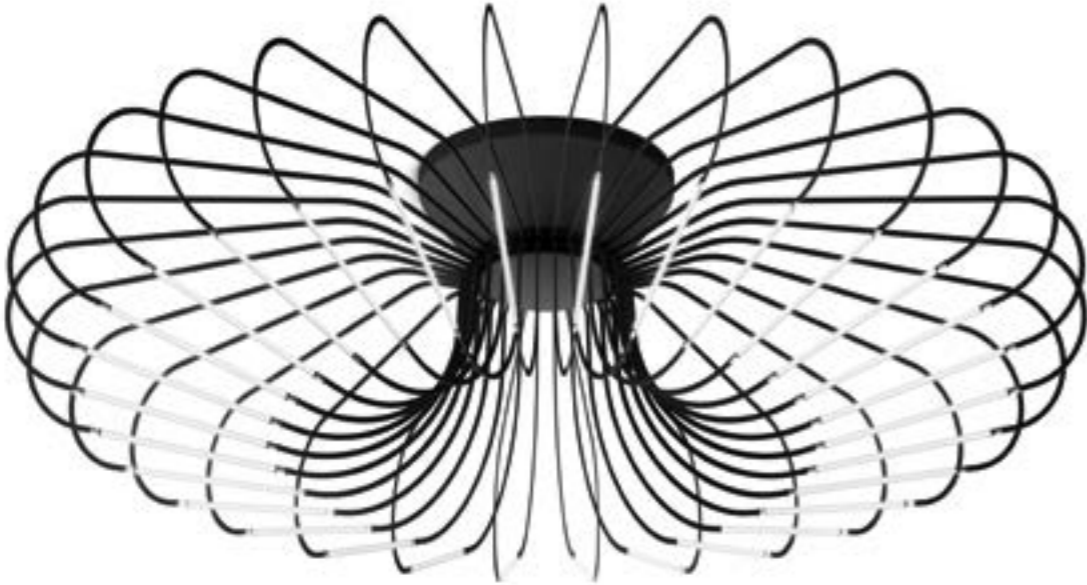



FILO CEILING



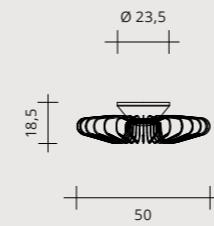
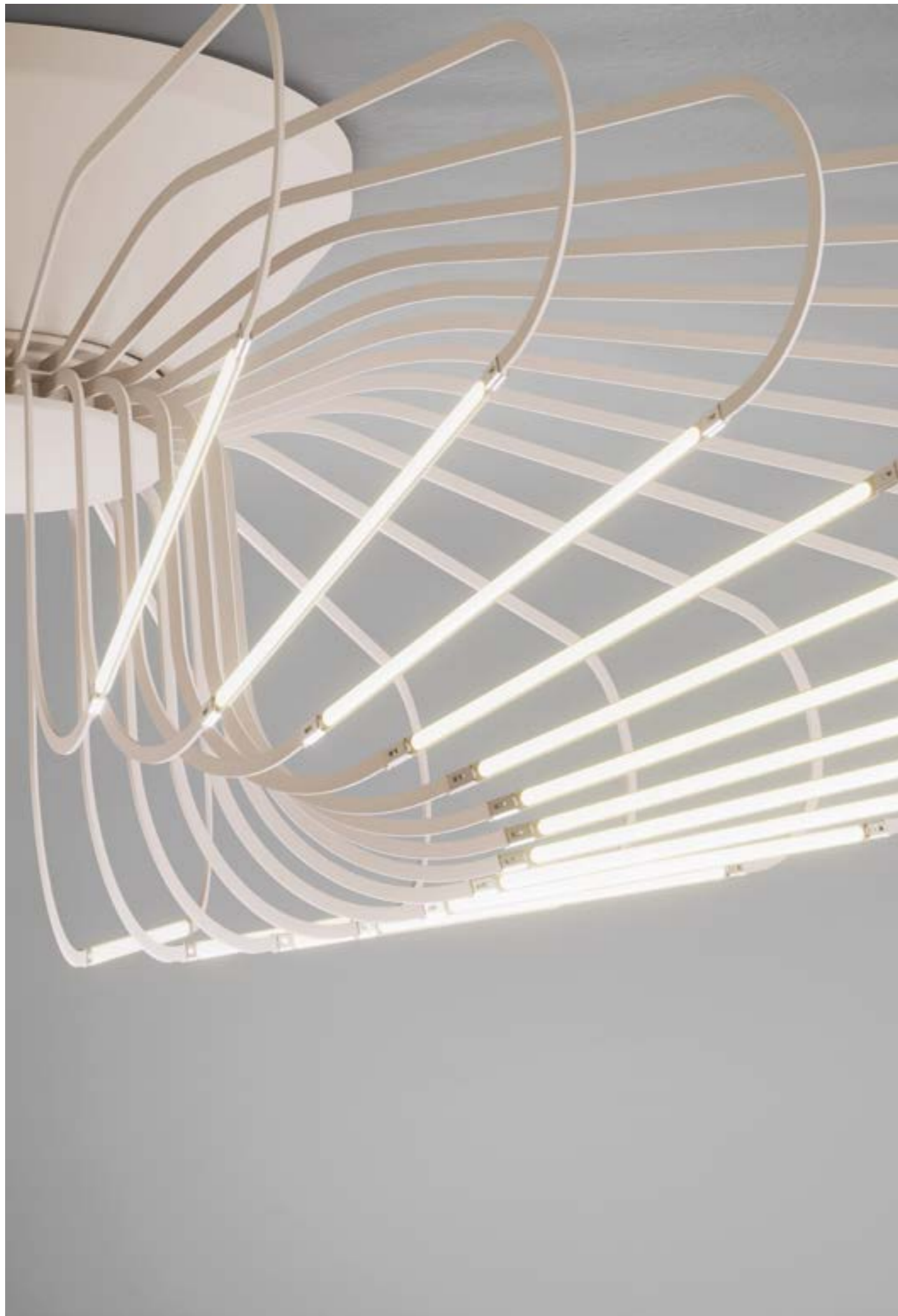

LED 36W - 24V
2700°K / 2460 lumen
3000°K / 2750 lumen

Versions:

On-Off

Push
Dali
0-10v
1-10v

Triac

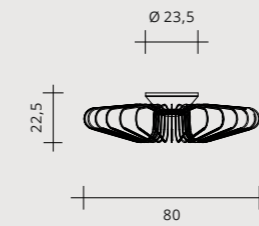

LED 51W - 24V
2700°K / 4568 lumen
3000°K / 5076 lumen

Versions:

On-Off

Push
Dali
0-10v
1-10v

Triac

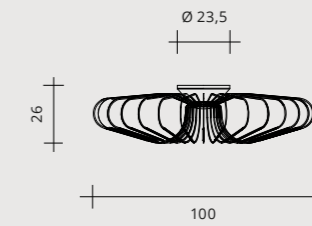

LED 51W - 24V
2700°K / 4568 lumen
3000°K / 5076 lumen

Versions:

On-Off

Push
Dali
0-10v
1-10v

Triac

FILO Ceiling

Lampada da soffitto
Deckenleuchte
Lámpara de techo
Потолочная лампа



FINISHES / FINITURE / FARBE / ACABADOS / ОТДЕЛКИ

- Matt powder pink / Cipria opaco / Puderfarben matt / Rosa palo mate / Пудровый матовый
- Titanium / Titanio / Titan / Titanio / Титан

CARTESIAN

Gerardo Mari

CARTESIAN

Technique, expressiveness, pure contemporary energy. This lighting system consists of light modules connected to one another through elements fixed to the wall, ceiling or suspended. The connection bases can connect up to 4 different modules in a linear or 90° layout, to create paths, different Cartesian geometries and light grids. Simply attach the connection bases so that the light modules can interlock. Only the first connection base needs to be powered, the rest of the current passes through the light modules.

CARTESIAN

Tecnica, espressività, pura energia contemporanea. È un sistema di illuminazione composto da moduli di luce che si collegano tra di loro con elementi di connessione fissati al muro, al soffitto o sospesi. Le basi di connessione collegano fino a 4 moduli diversi in modo lineare o a 90°, permettendo di creare percorsi, geometrie cartesiane diverse e griglie di luce. È sufficiente fissare le basi di connessione perché i moduli di luce si colleghino a incastro. Soltanto una prima base di connessione ha bisogno di essere alimentata, il resto della corrente passa attraverso i moduli di luce.

CARTESIAN

Technik, Ausdruckskraft, pure zeitgenössische Energie. Es handelt sich um ein Beleuchtungssystem, das aus Lichtmodulen besteht, die sich miteinander dank Verbindungselementen verbinden, die an der Wand, der Decke oder aufgehängt sind. Die Verbindungssockel verbinden bis zu 4 verschiedene Module linear oder um 90° versetzt und ermöglichen die Erstellung von Pfaden, verschiedenen kartesischen Geometrien und Lichtgittern. Einfach die Anschlusssockel so anbringen, dass die Lichtmodule sich verzahnen. Nur eine erste Anschlussbasis muss mit Strom versorgt werden, der Rest des Stromnetzes geht durch die Lichtmodule.

CARTESIAN

Técnica, expresividad, pura energía contemporánea. Es un sistema de iluminación compuesto por módulos luminosos que se conectan entre ellos con elementos de unión fijados a la pared, al techo o suspendidos. Las bases de conexión conectan hasta 4 módulos diferentes de forma lineal o a 90°, lo que permite crear recorridos, geometrías cartesianas diferentes y rejillas de luz. Basta con colocar las bases de conexión de modo que los módulos luminosos encajen. Solo es necesario alimentar la primera base de conexión, el resto de la corriente pasa a través de los módulos luminosos.

CARTESIAN

Техничность, экспрессия, яркая современная энергия. Эта система освещения состоит из световых модулей, которые соединяются друг с другом с помощью элементов, крепящихся к стене или к потолку либо подвесных. Соединительные планки могут соединять до 4 различных модулей. Соединение может быть линейным или располагаться под углом 90°, что позволяет создавать различные конфигурации, композиции из геометрических фигур и световые сетки. Чтобы обеспечить взаимное сцепление световых модулей, достаточно закрепить соединительные планки. В подаче питания нуждается лишь первая соединительная планка: далее ток проходит через световые модули.

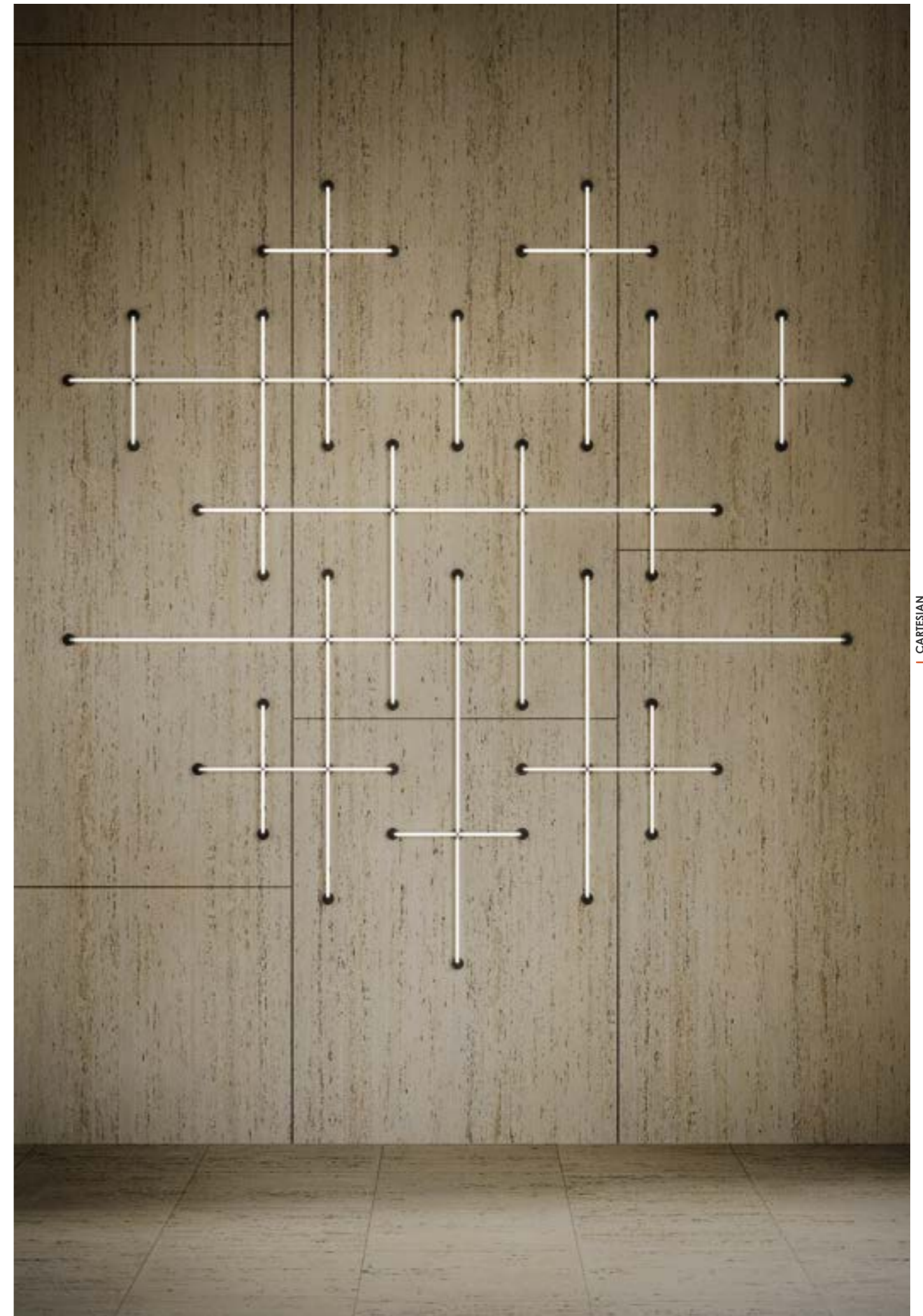

CARTESIAN SURFACE MOUNTING



CARTESIAN

SURFACE MOUNTING



CARTESIAN

SURFACE MOUNTING



CARTESIAN SURFACE MOUNTING



CARTESIAN

SURFACE MOUNTING

CARTESIAN Surface mounting

Modular lighting system
Sistema d'illuminazione modulare
Modulares Beleuchtungssystem
Sistema de iluminación modular
Модульная система освещения

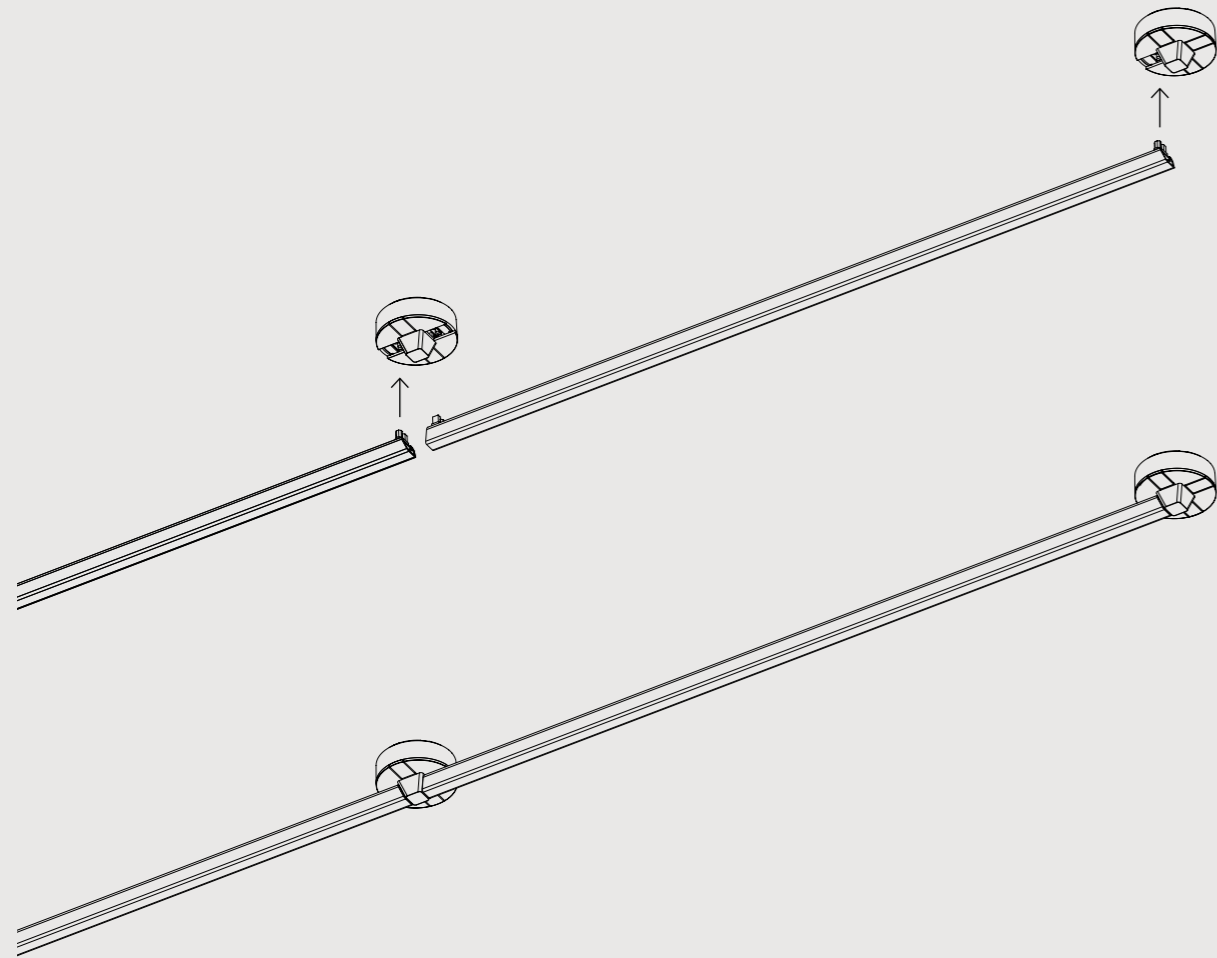
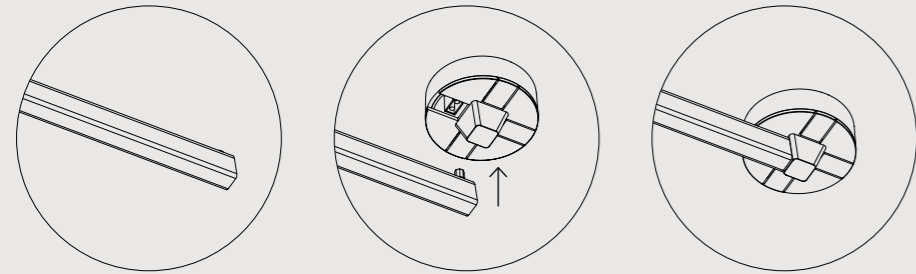

Configurations available

Possibili configurazioni / Mögliche Konfigurationen / Posibles configuraciones / Возможные конфигурации

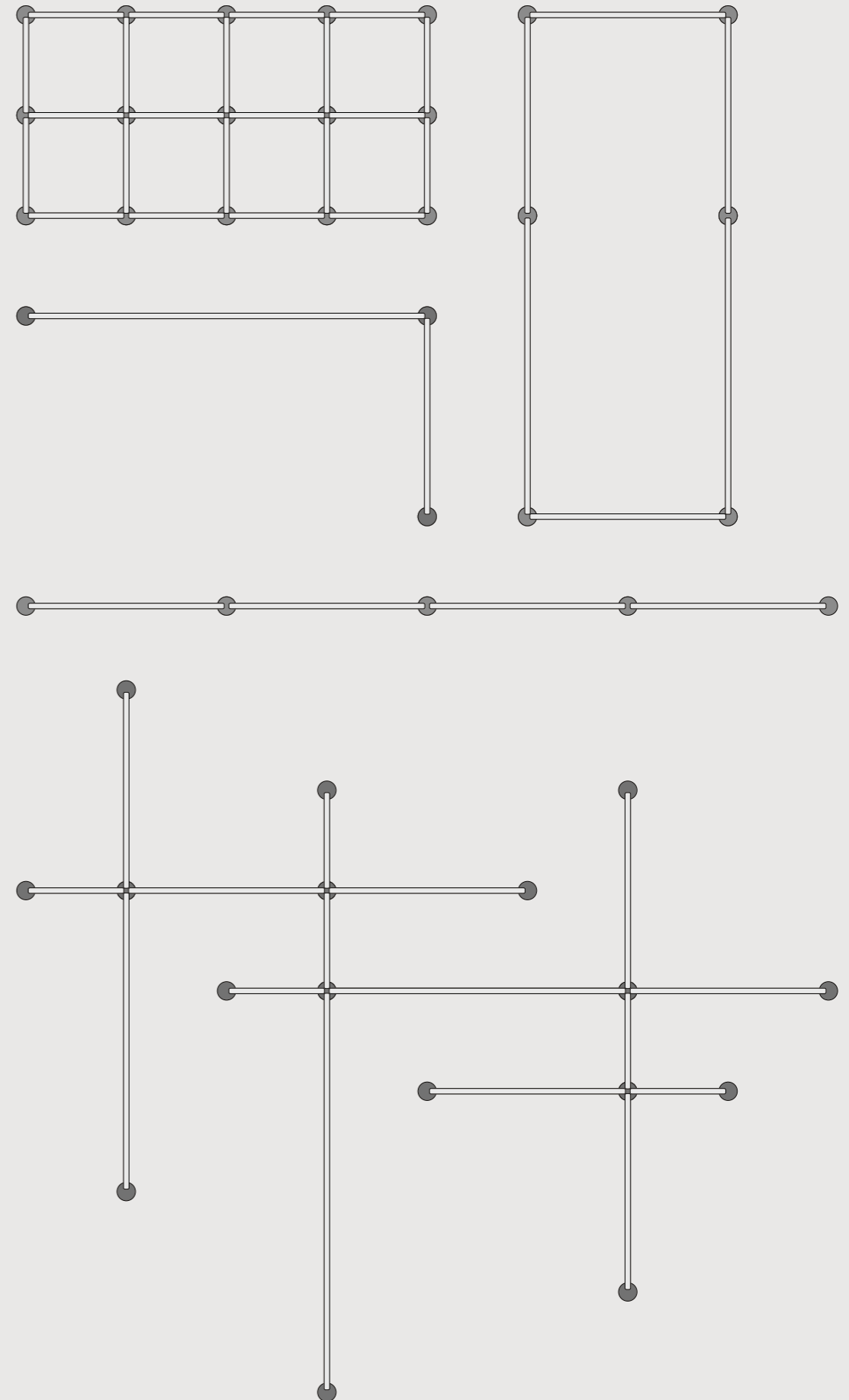

CARTESIAN

Surface mounting

Modular lighting system
 Sistema d'illuminazione modulare
 Modulares Beleuchtungssystem
 Sistema de iluminación modular
 Модульная система освещения



FINISHES / FINITURE / FARBE / ACABADOS / ОТДЕЛКИ

CONNECTORS, DRIVER BOX

Connettori, driver box / Steckverbinder, Treiberboxen /
 Conectores, cajas de controladores / Коннекторы, драйверы в корпусе

- Black / Nero / Schwarz / Negro / Чёрный цвет

LIGHT MODULE

Modulo luce / Lichtmodul / Módulo luminoso / Световой модуль

- White opal polycarbonate / Policarbonato bianco opale / Weißes opales Polycarbonat /
 Policarbonato blanco opalino / Поликарбонат опаловый белый

LIGHT SOURCE / SORGENTE / LICHTQUELLE / FUENTE LUMINOSA / ИСТОЧНИК СВЕТА

30 cm.	LED 5W	24V	2700°K / 590 Lumen 3000°K / 656 Lumen	CRI 90 CRI 90
60 cm.	LED 10W	24V	2700°K / 1171 Lumen 3000°K / 1302 Lumen	CRI 90 CRI 90
90 cm.	LED 15W	24V	2700°K / 1661 Lumen 3000°K / 1846 Lumen	CRI 90 CRI 90
120 cm.	LED 20W	24V	2700°K / 2354 Lumen 3000°K / 2616 Lumen	CRI 90 CRI 90

MODULE / MODULO / MODUL / MÓDULO / МОДУЛЬ

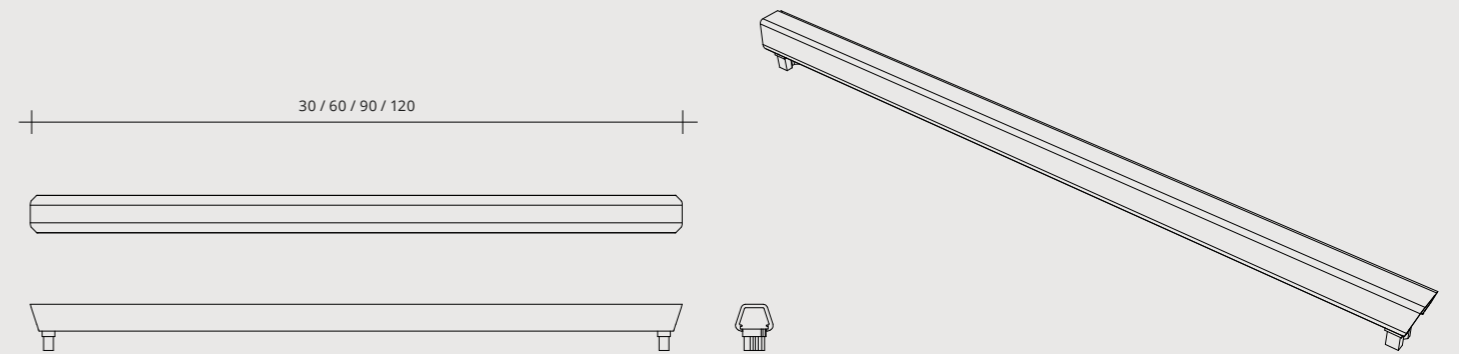

CONNECTOR / CONNETTORE / VERBINDUNGSTEIL / CONECTOR / КОННЕКТОР

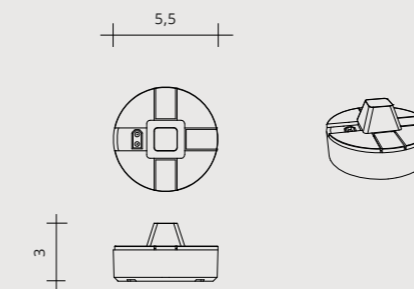

DRIVER BOX

On-Off
up to 200W

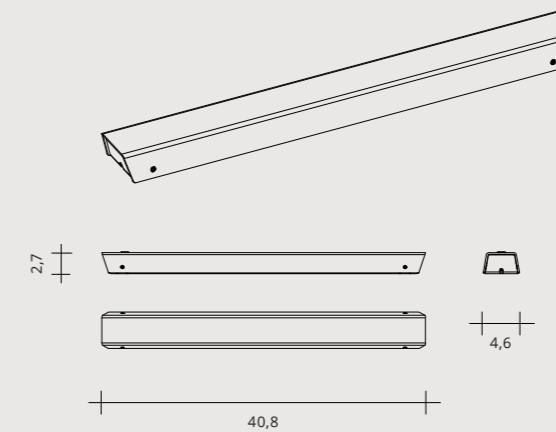

DRIVER BOX

Dimmer
(dali / push / 0-10V / 1-10V)
up to 200W

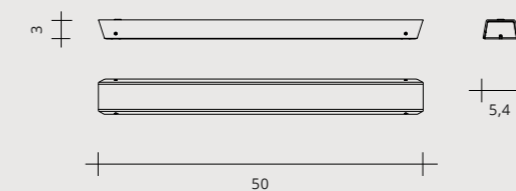

CARTESIAN SUSPENSION



CARTESIAN SUSPENSION



CARTESIAN SUSPENSION

CARTESIAN

Surface mounting

Modular lighting system
 Sistema d'illuminazione modulare
 Modulares Beleuchtungssystem
 Sistema de iluminación modular
 Модульная система освещения



FINISHES / FINITURE / FARBE / ACABADOS / ОТДЕЛКИ

CONNECTORS, DRIVER BOX

Connettori, driver box / Steckverbinder, Treiberboxen /
 Conectores, cajas de controladores / Коннекторы, драйверы в корпусе

- Black / Nero / Schwarz / Negro / Чёрный цвет

LIGHT MODULE

Modulo luce / Lichtmodul / Módulo luminoso / Световой модуль

- White opal polycarbonate / Policarbonato bianco opale / Weißes opales Polycarbonat /
 Policarbonato blanco opalino / Поликарбонат опаловый белый

LIGHT SOURCE / SORGENTE / LICHTQUELLE / FUENTE LUMINOSA / ИСТОЧНИК СВЕТА

30 cm.	LED 5W	24V	2700°K / 590 Lumen 3000°K / 656 Lumen	CRI 90 CRI 90
60 cm.	LED 10W	24V	2700°K / 1171 Lumen 3000°K / 1302 Lumen	CRI 90 CRI 90
90 cm.	LED 15W	24V	2700°K / 1661 Lumen 3000°K / 1846 Lumen	CRI 90 CRI 90
120 cm.	LED 20W	24V	2700°K / 2354 Lumen 3000°K / 2616 Lumen	CRI 90 CRI 90

MODULE / MODULO / MODUL / MÓDULO / МОДУЛЬ

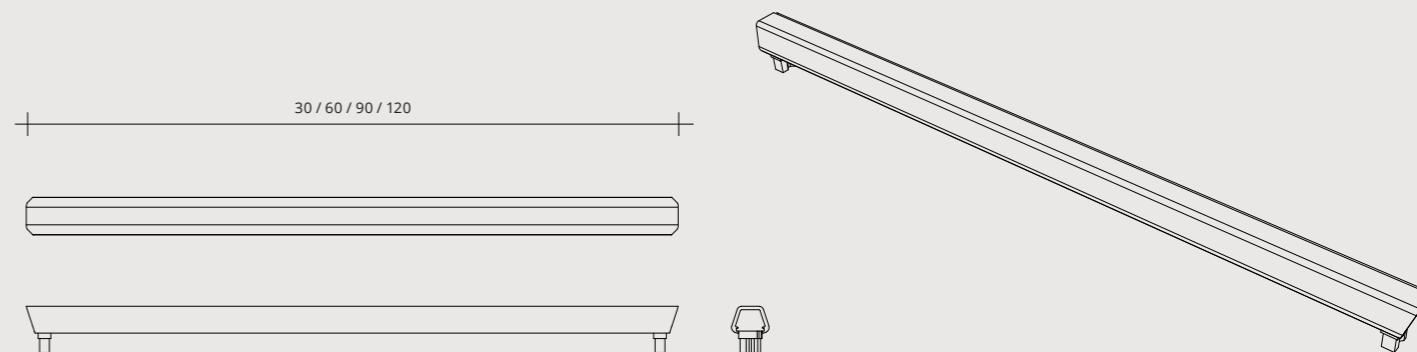

CONNECTOR / CONNETTORE / VERBINDUNGSTEIL / CONECTOR / КОННЕКТОР

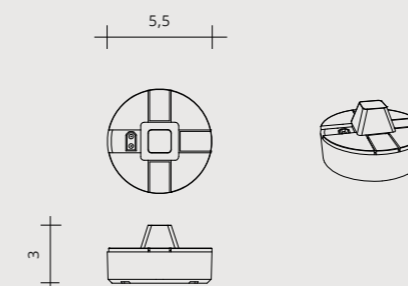

DRIVER BOX

On-Off
up to 200W

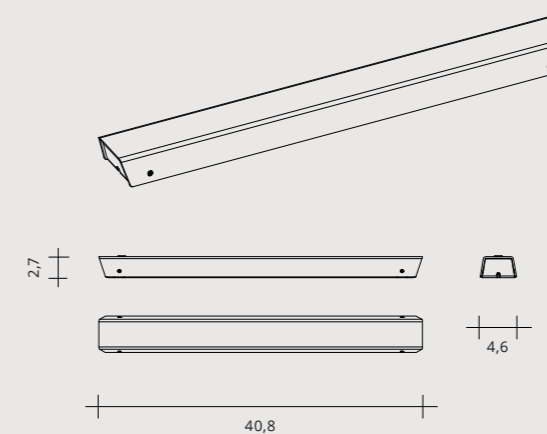

DRIVER BOX

dimmer
(dali / push / 0-10V / 1-10V)
up to 200W

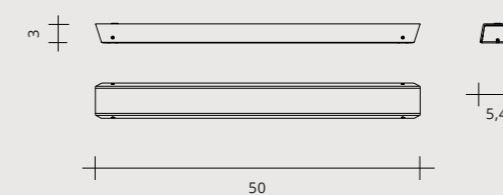

See codes and prices from page to page / Vedi codici e prezzi da pag a pag. / Artikelnummern und Preise siehe Seite bis Seite
 Véanse códigos y precios desde pag. hasta pag. / См. коды и цены от страницы до страницы

321 - 322

EG COLLECTION

Moon and star.
A ceiling light that conveys the discreet charm of rigorous minimal elegance, redefining the essential features of lighting comfort with a timeless design. This is Eg. Refined, discreet, soft and cosy, it looks like a porthole in the ceiling through which natural diffuse light passes. An idea of elegance and lightness that harmoniously expresses form and discretion, on which light is modelled as a protagonist, opening up new spaces.



EG
Luna e stella.
Una plafoniera che sa raccontare il fascino discreto della rigorosa eleganza minimale, ridisegnando i tratti essenziali del comfort dell'illuminazione con un design enza tempo.
Questa è Eg. Raffinata, discreta, morbida e accogliente, si presenta come un oblò sul soffitto da cui passa luce diffusa naturale. Un'idea di eleganza e leggerezza che esprime in modo armonico, forma e discrezione, sulle quali si modella da protagonista la luce, che apre nuovi spazi.

EG
Mond und Stern.
Eine Deckenleuchte, die den diskreten Charme einer strengen, minimalen Eleganz ausstrahlt und die wesentlichen Merkmale des Beleuchtungskomforts mit einem zeitlosen Design neu definiert. Das ist Eg. Raffiniert, diskret, weich und gemütlich wirkt sie wie ein Bullauge in der Decke, durch das natürliches, diffuses Licht fällt. Eine Idee von Eleganz und Leichtigkeit, die Form und Diskretion harmonisch zum Ausdruck bringt, bei der das Licht als Protagonist fungiert und neue Räume eröffnet.

EG
Luna y estrella.
Una lámpara de techo que transmite el discreto encanto de una rigurosa elegancia minimalista, redefiniendo las características esenciales del confort lumínico con un diseño atemporal. Esta es Eg. Refinada, discreta, suave y acogedora, parece un ojo de buey en el techo por el que pasa la luz natural difusa. Una idea de elegancia y ligereza que expresa armoniosamente forma y discreción, en la que a luz se modela como protagonista abriendo nuevos espacios.

EG
Луна и звезда.
Потолочный светильник, который олицетворяет сдержанное очарование строгой и минималистичной элегантности: новая интерпретация основных качеств комфортного освещения под знаком вневременного дизайна. Все это - светильник Eg. Изысканный, неброский, мягкий и уютный светильник напоминает иллюминатор в потолке, через который льется естественный рассеянный свет. Идея элегантности и легкости, гармоничным образом воплощенная в лаконичности форм, над которыми безраздельно властвует свет, распахивающий новые пространства.



EG WALL | CEILING







EG WALL | CEILING



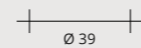
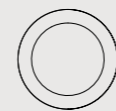
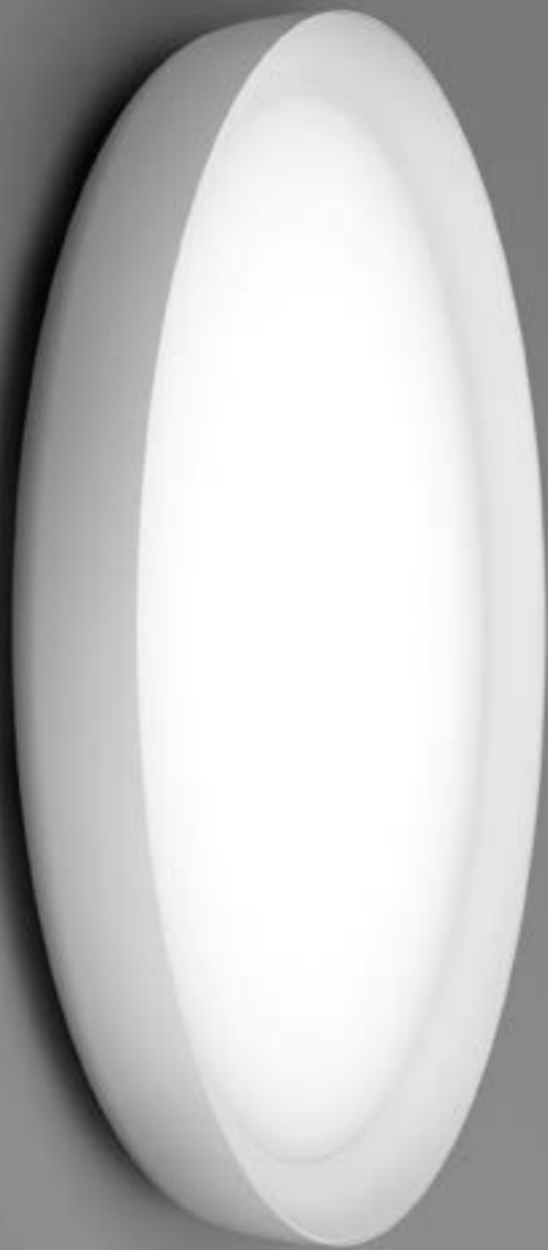

LED 33W
3000°K / 1664 lumen

Version:

On-Off

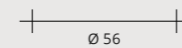
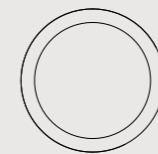
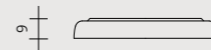

LED 42W
3000°K / 2585 lumen

Version:

On-Off

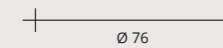
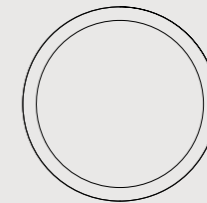

LED 63W
3000°K / 3850 lumen

Version:

On-Off

EG Wall | Ceiling

Lampada da soffitto e parete

Deck-und Wandlampen

Plafón y arliqueПотолочный и настенный светильник



FINISHES / FINITURE / FARBE / ACABADOS / ОТДЕЛКИ

- White / Bianco / Weiß / Blanco / Белый цвет
- Turtledove grey / Tortora / Taubengrau / Gris paloma / Тауп
- Dark grey / Grigio scuro / Dunkelgrau / Gris oscuro / Темно-серый

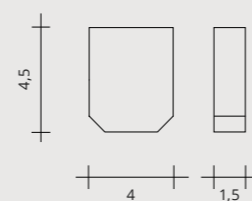

OPTIONAL

DIM001:

Phase-cut dimmer

Dimmer a taglio di fase

Phasenanschnitt-Dimmer

Reguladores de fase

Диммер с отсечкой фазы

ANELLO

SUSPENSION

Urban Design Team

ANELLO

The purest form in its minimal interpretation. A perfect suspended circle, described in space by a thin aluminium body. A continuous, discrete internal thread of light that illuminates the environment evenly. Dimmable version available.

ANELLO

La forma più pura nella sua declinazione minima. Un cerchio perfetto sospeso, descritto nello spazio da un sottile corpo in alluminio. Un filo continuo, discreto, di luce interno che illumina l'ambiente in modo uniforme. Disponibile anche in versione dimmerabile.

ANELLO

Die reinste Form in ihrer minimalen Deklination. Ein perfekter Kreis, beschrieben im Raum durch ein dünnes Aluminiumgehäuse. Ein kontinuierlicher Faden, diskret inneren Lichtes, das den Raum gleichmäßig beleuchtet. Auch eine dimmbare Inversion ist verfügbar.

ANELLO

La forma más pura en su mínima declinación. Un círculo perfecto suspendido, descrito en el espacio por un sutil cuerpo de aluminio. Un hilo continuo, discreto, de luz interior que ilumina el ambiente de manera uniforme. Disponible también la versión regulable.

ANELLO

Чистейшая форма в ее минималистичном воплощении. Безупречный круг, парящий в пространстве и очерченный тонким алюминиевым корпусом. Сплошная струя благородного света внутри круга равномерно освещает помещение. Также имеется диммируемая версия.



ANELLO CEILING

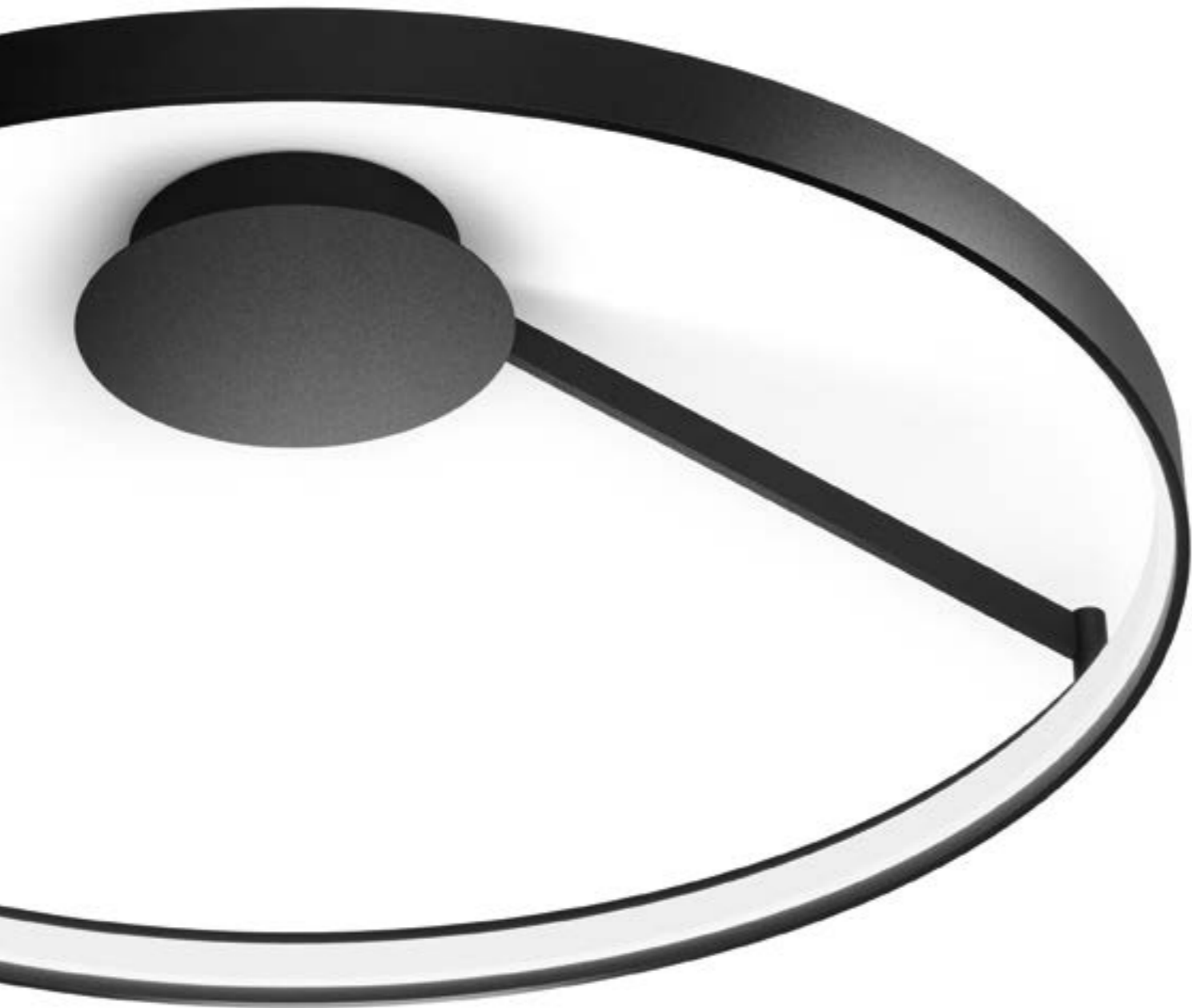

ANELLO CEILING

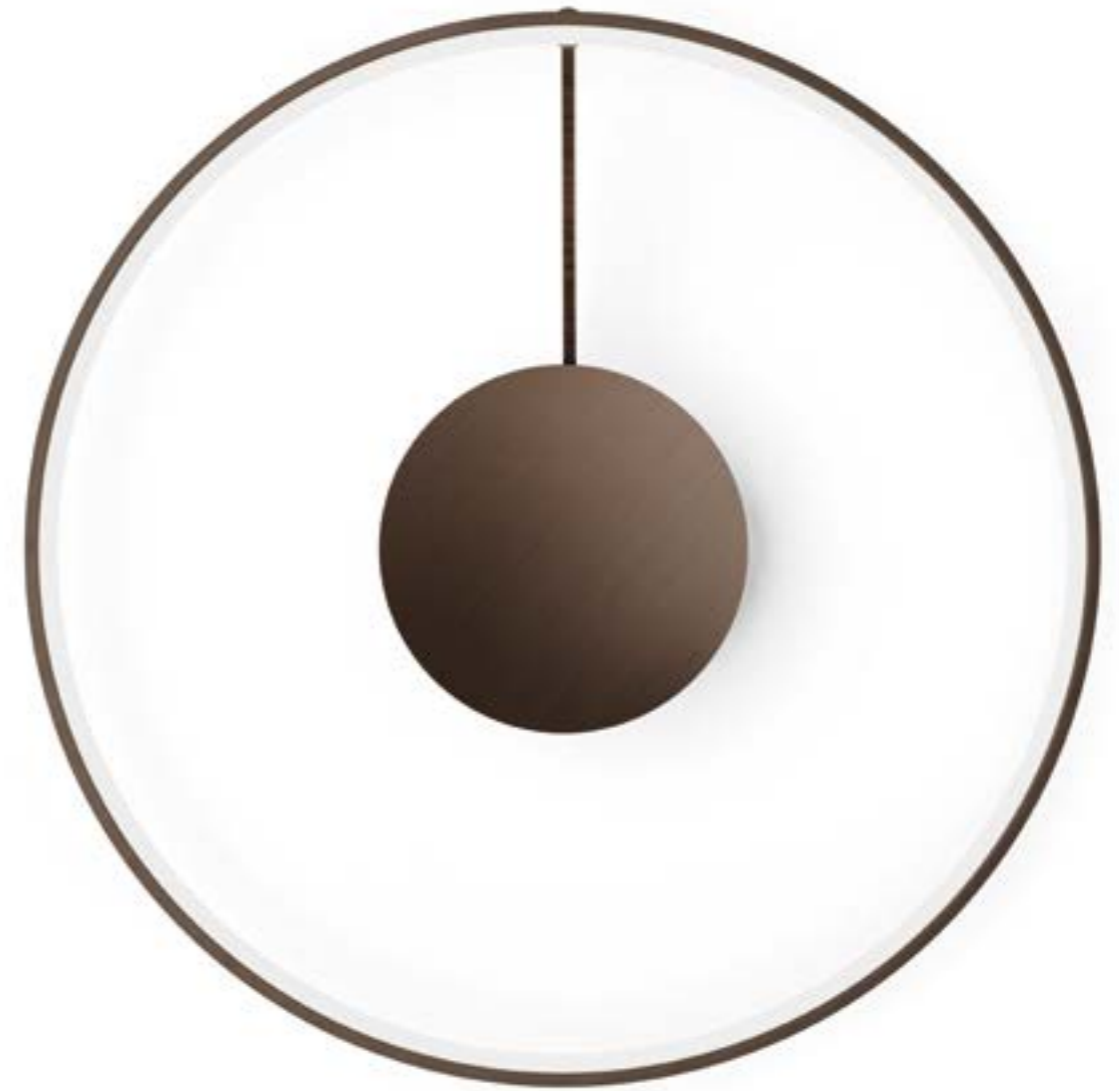

ANELLO CEILING





ANELLO CEILING



ANELLO CEILING



ANELLO

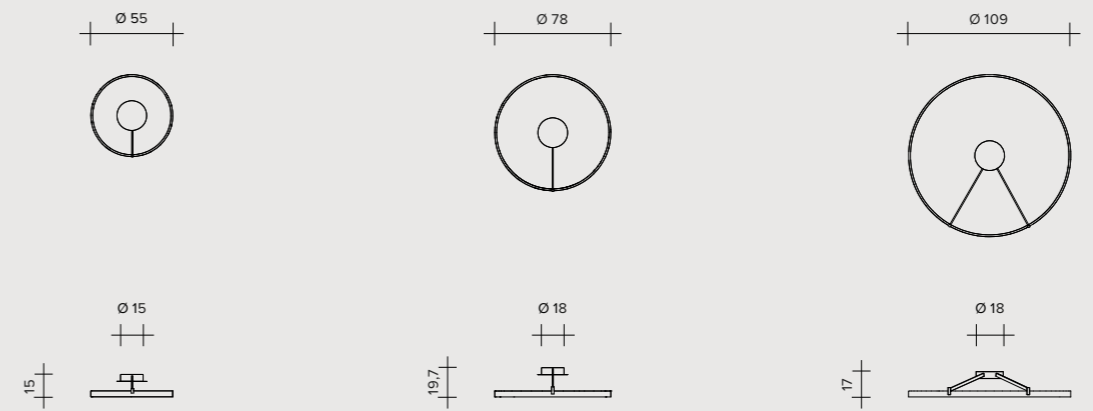

LED 33W - 24V
2700°K / 2668 lumen
3000°K / 2965 lumen

Versions:

On-Off

Push
Dali
0-10v
1-10v

LED 47W - 24V
2700°K / 2761 lumen
3000°K / 3068 lumen

Versions:

On-Off

Push
Dali
0-10v
1-10v

Triac

LED 65W - 24V
2700°K / 3832 lumen
3000°K / 4258 lumen

Versions:

On-Off

Push
Dali
0-10v
1-10v

Triac

ANELLO Ceiling

Lampada da soffitto
Deckenleuchte
Lámpara de techo
Потолочная лампа

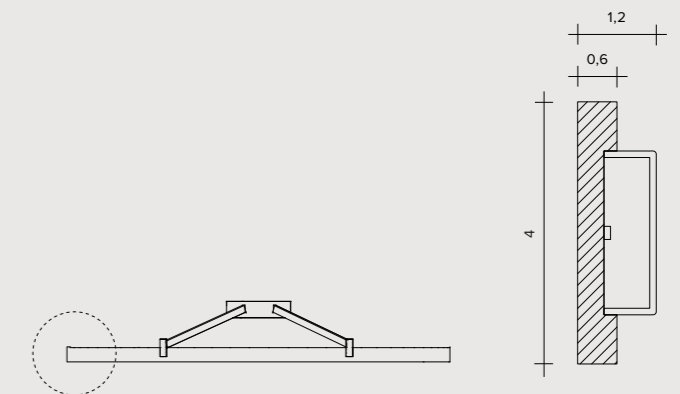

FINISHES / FINITURE / FARBE / ACABADOS / ОТДЕЛКИ

- Painted black / Nero Verniciato / Schwarz lackiert
Negro Pintado / Окрашенный в черный цвет
- Brushed Bronze / Bronzo Spazzolato / Bronze gebürstet
Bronce cepillado / Брашированная бронза
- Brushed Gold / Oro Spazzolato / Gold gebürstet
Oro cepillado / Брашированное золото
- Brushed Copper / Rame Spazzolato / Kupfer gebürstet
Cobre cepillado / Брашированная медь

ANELLO SUSPENSION

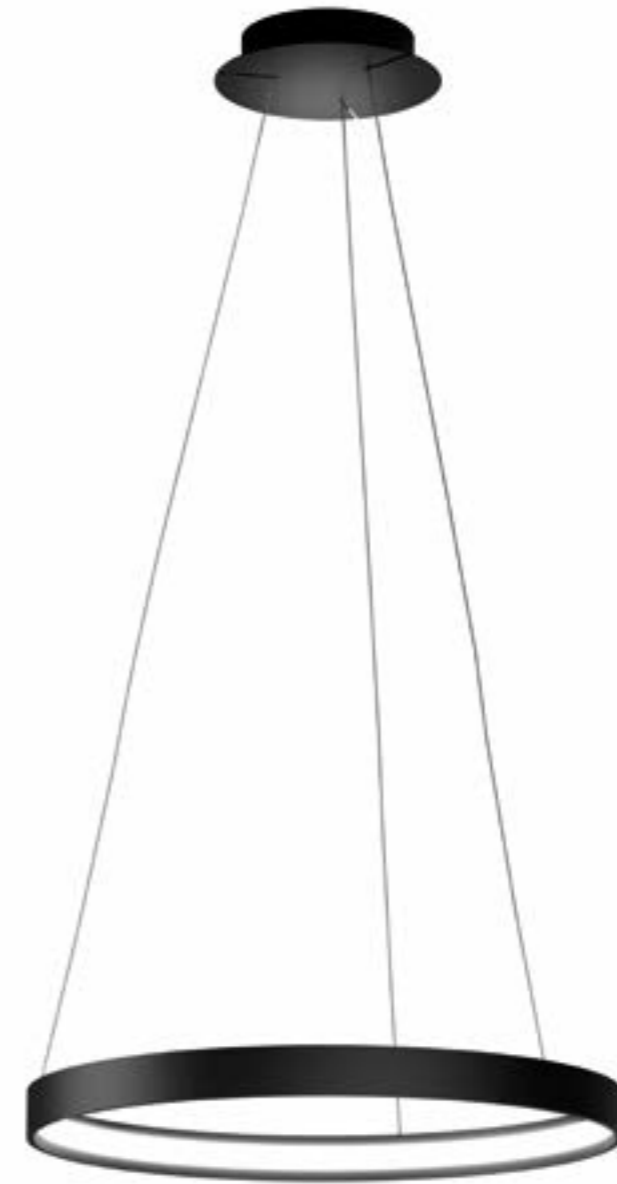

ANELLO SUSPENSION





ANELLO SUSPENSION

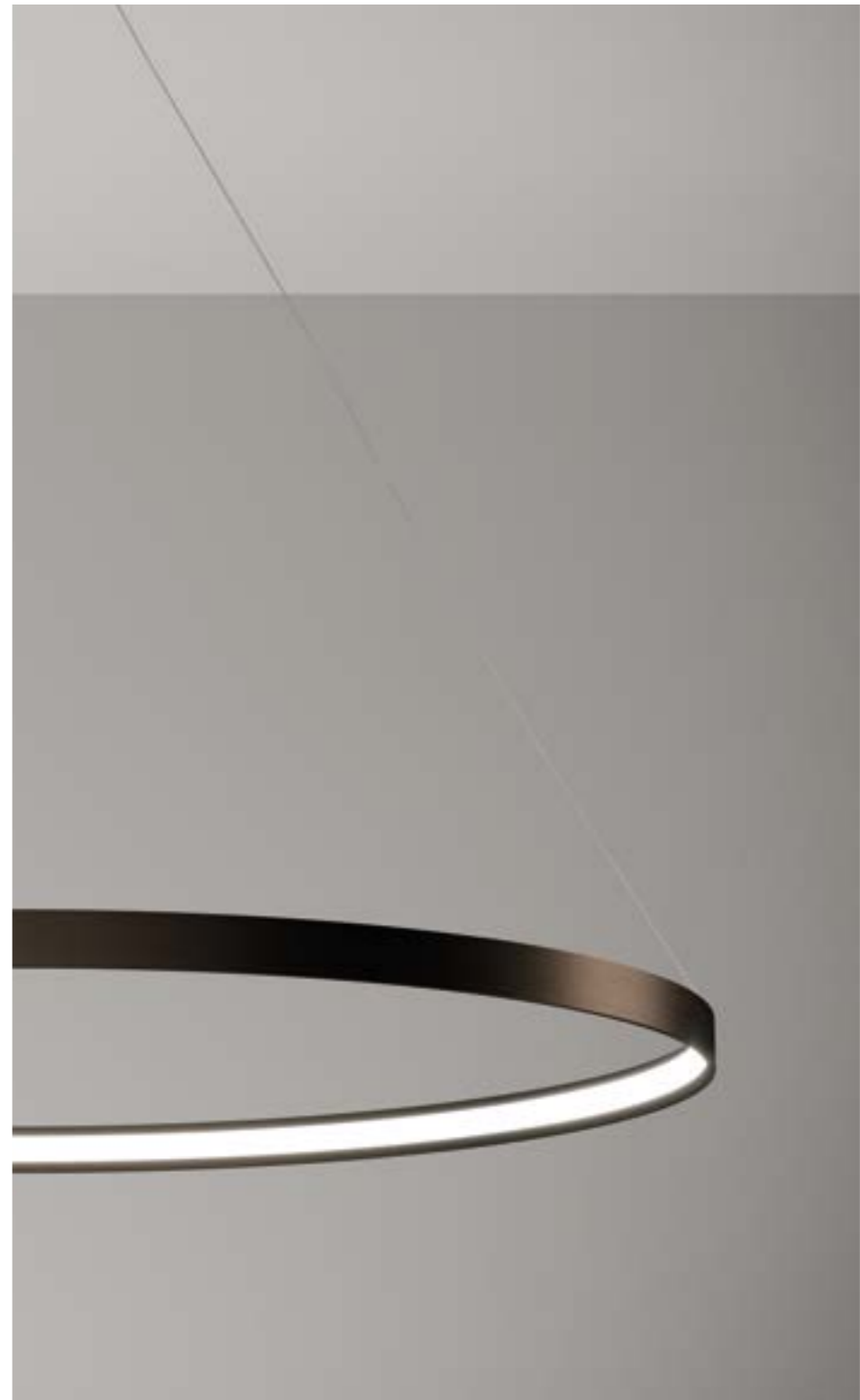

ANELLO SUSPENSION

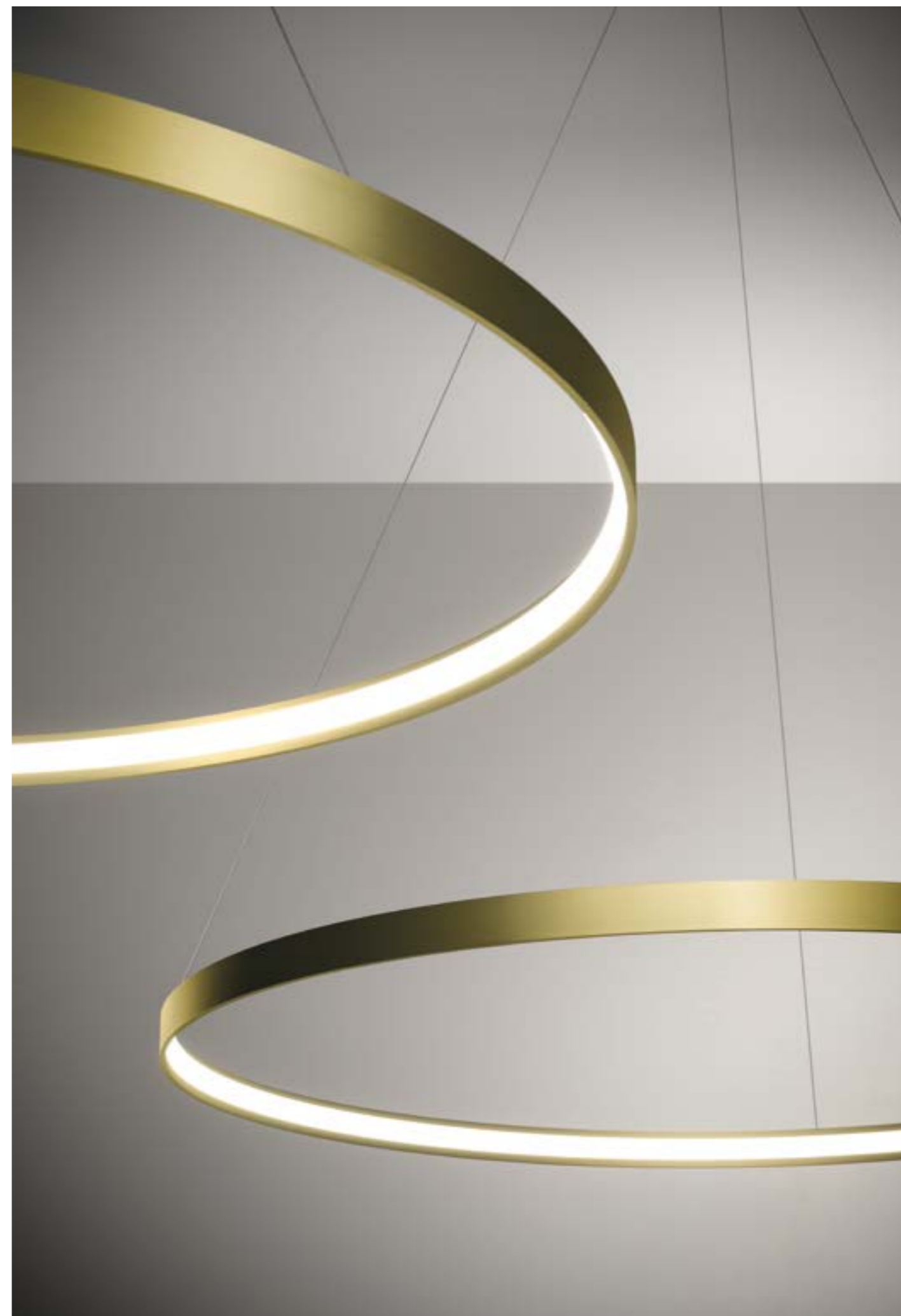

ANELLO SUSPENSION

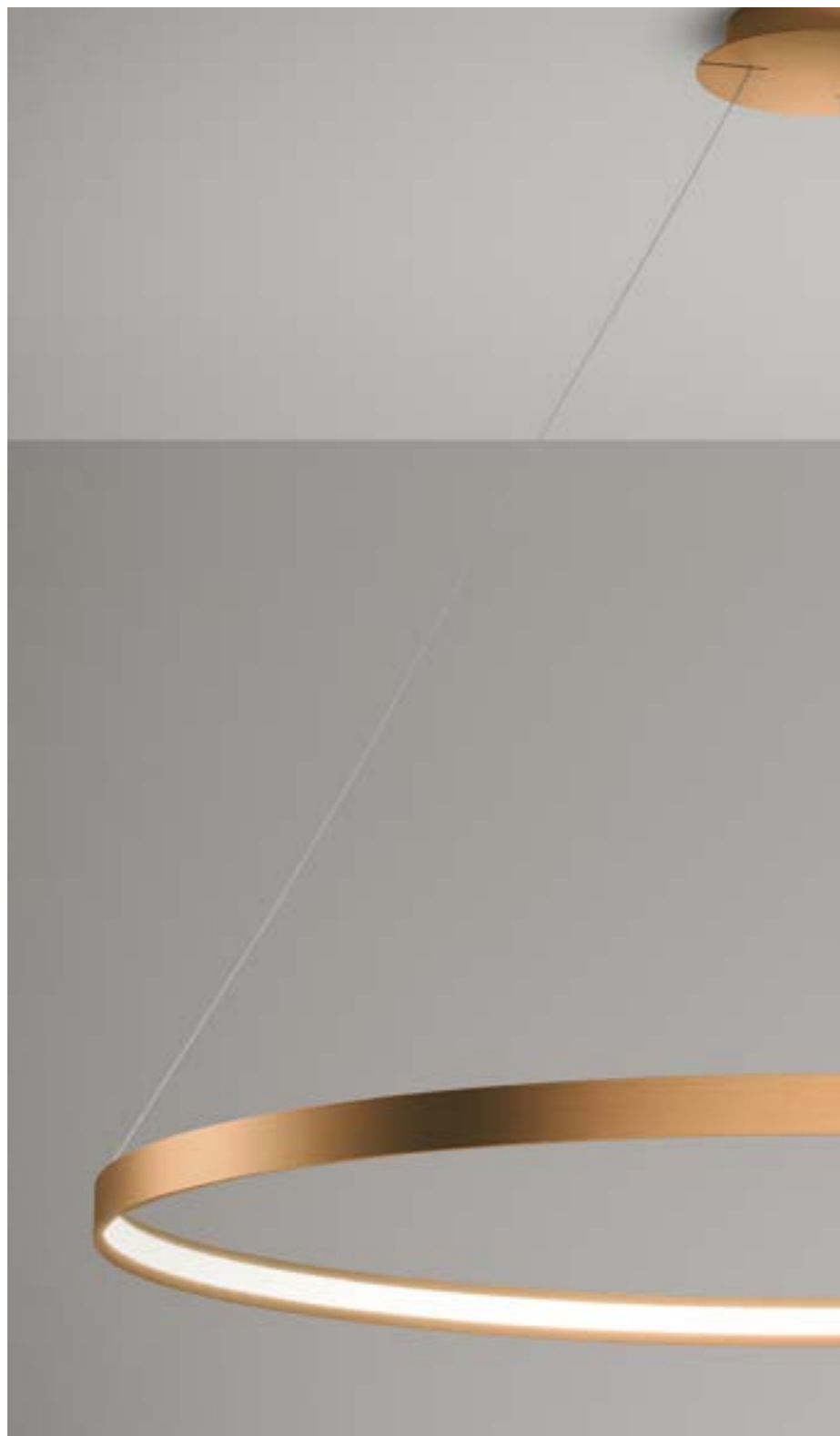

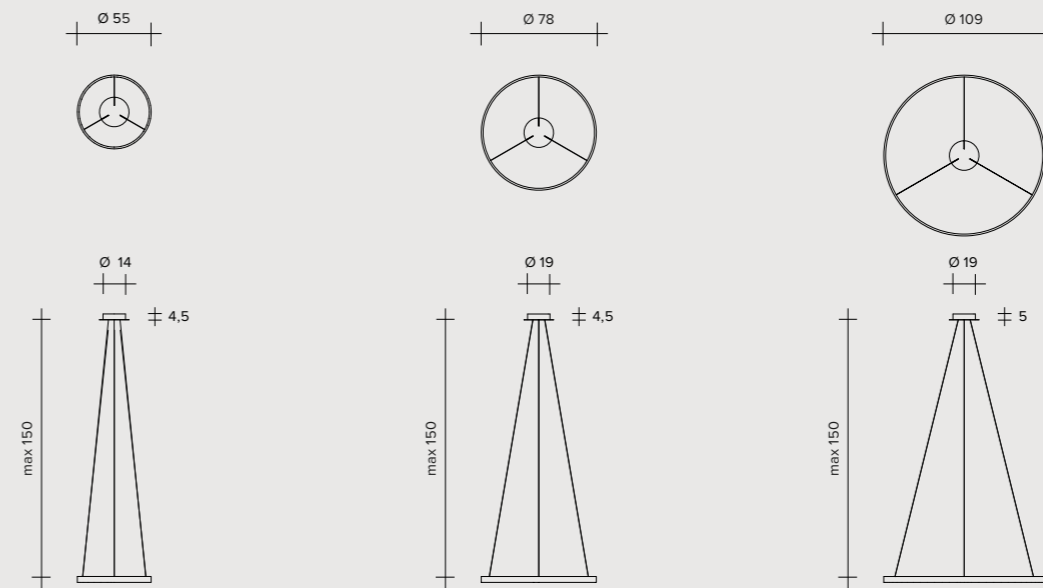

LED 33W - 24V
2700°K / 2668 lumen
3000°K / 2965 lumen

Versions:

On-Off

Push
Dali
0-10v
1-10v

LED 47W - 24V
2700°K / 2761 lumen
3000°K / 3068 lumen

Versions:

On-Off

Push
Dali
0-10v
1-10v

Triac

LED 65W - 24V
2700°K / 3832 lumen
3000°K / 4258 lumen

Versions:

On-Off

Push
Dali
0-10v
1-10v

Triac

ANELLO Suspension

Lampada a sospensione
Pendelleuchte
Lámpara colgante
Подвесная лампа

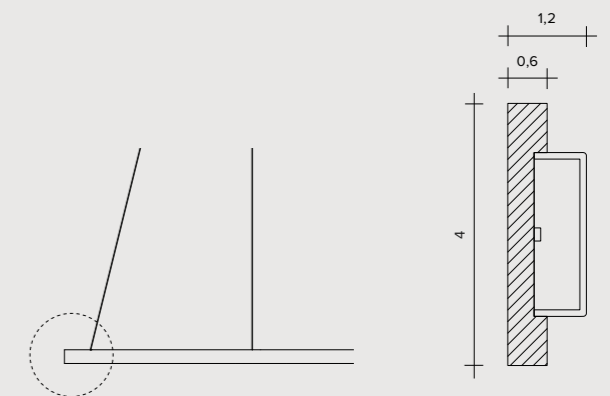

FINISHES / FINITURE / FARBE / ACABADOS / ОТДЕЛКИ

- Painted black / Nero Verniciato / Schwarz lackiert
Negro Pintado / Окрашенный в черный цвет
- Brushed Bronze / Bronzo Spazzolato / Bronze gebürstet
Bronce cepillado / Брашированная бронза
- Brushed Gold / Oro Spazzolato / Gold gebürstet
Oro cepillado / Брашированное золото
- Brushed Copper / Rame Spazzolato / Kupfer gebürstet
Cobre cepillado / Брашированная медь

ANELLO DOUBLE SUSPENSION

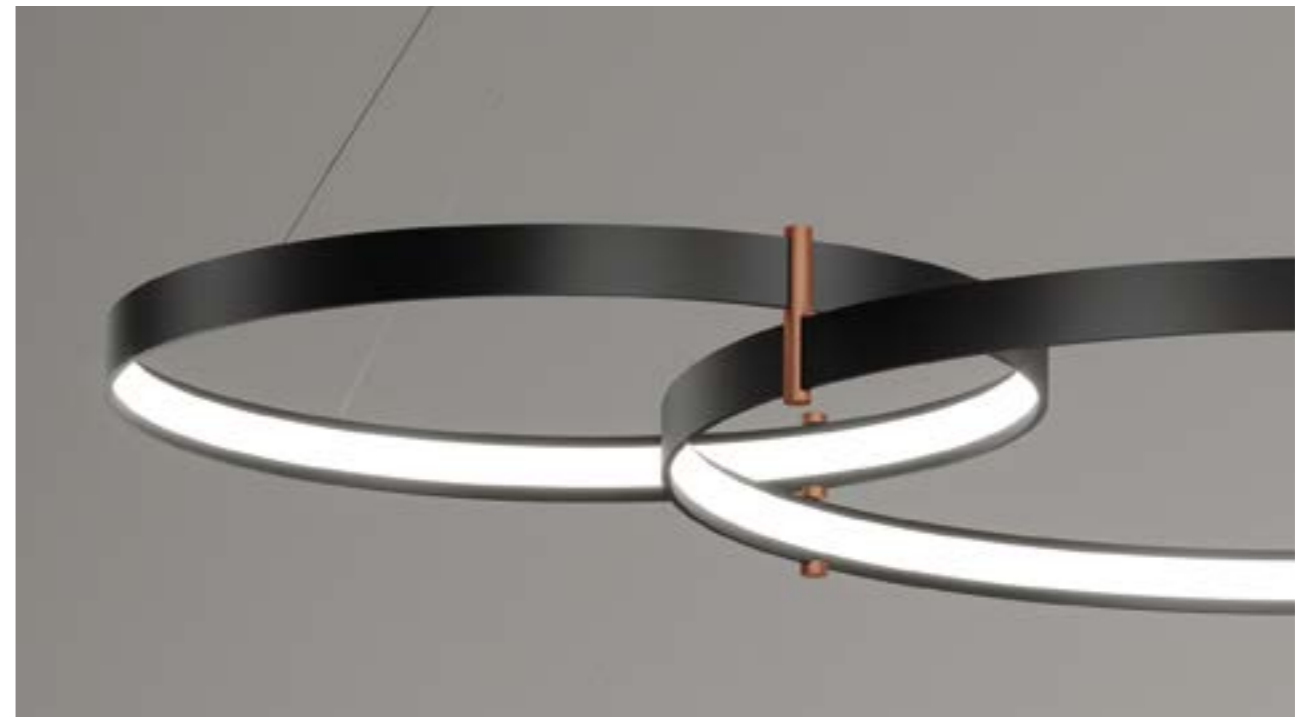

ANELLO DOUBLE
SUSPENSION



ANELLO

DOUBLE
SUSPENSION



ANELLO

ANELLO DOUBLE
SUSPENSION



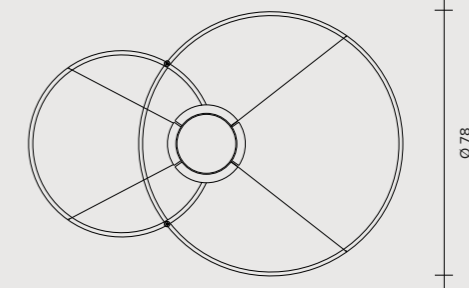
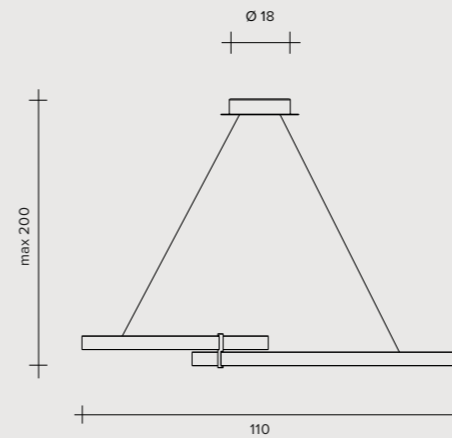

LED 80 W - 24V
2700°k / 5429 lumen
3000°K / 6033 lumen

Versions:

On-Off

Push
Dali
0-10v
1-10v

Triac

ANELLO Double Suspension

Lampada a sospensione
Pendelleuchte
Lámpara colgante
Подвесная лампа



FINISHES / FINITURE / FARBE / ACABADOS / ОТДЕЛКИ

- Painted black / Nero Verniciato / Schwarz lackiert
Negro Pintado / Окрашенный в черный цвет
- Brushed Bronze / Bronzo Spazzolato / Bronze gebürstet
Bronce cepillado / Брашированная бронза
- Brushed Gold / Oro Spazzolato / Gold gebürstet
Oro cepillado / Брашированное золото
- Brushed Copper / Rame Spazzolato / Kupfer gebürstet
Cobre cepillado / Брашированная медь



Joint kit for double suspension Anello (Not included, available as optional)

Kit giunti per anello double suspension (Non incluso, da ordinare a parte)
Verbindungssatz für Anello doppelte Aufhängung (Nur Ringe, Join Kit nicht inbegriffen)
Kit juntas para anello double suspension (Solo anillos, kit de junta no incluido)
Комплект креплений для anello double suspension (Не входит в комплект поставки, заказывается отдельно)

FINISHES / FINITURE / FARBE / ACABADOS / ОТДЕЛКИ

- Painted black / Nero Verniciato / Schwarz lackiert
Negro Pintado / Окрашенный в черный цвет
- Brushed Bronze / Bronzo Spazzolato / Bronze gebürstet
Bronce cepillado / Брашированная бронза
- Brushed Gold / Oro Spazzolato / Gold gebürstet
Oro cepillado / Брашированное золото
- Brushed Copper / Rame Spazzolato / Kupfer gebürstet
Cobre cepillado / Брашированная медь
- Aluminium / Alluminio / Aluminium
Aluminio / Алюминиевого

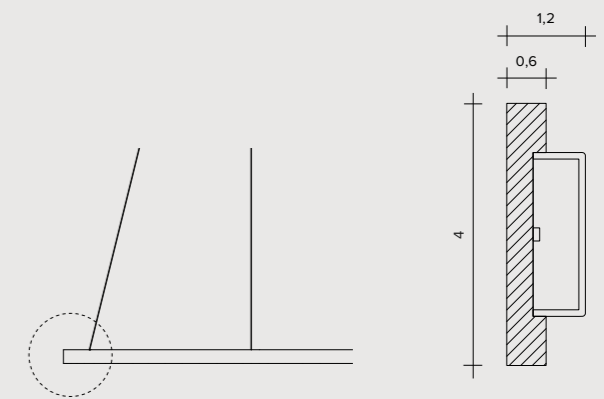

AKI

Extravergine

AKI

Discretion is the privilege of this wall lamp that expresses in the harmony of its shape the values associated with the concept of minimalist aesthetics. Moderation and restraint are the expressive measure of its recyclable die-cast aluminium body. Includes an integrated heat sink with LED to ensure performance, light quality and durability. The lighting is diffuse and washes the wall evenly.

AKI

Discrezione è il privilegio di questa lampada da parete che sa esprimere nell'armonia delle sue forme i valori legati al concetto di estetica minimalista. Moderazione e riserbo sono la misura espressiva del corpo in alluminio pressofuso riciclabile. Include un dissipatore integrato con un LED per garantire prestazioni, qualità della luce e durata. L'illuminazione è diffusa, e lava uniformemente la parete.

AKI

Diskretion ist das Privileg dieser Wandleuchte die in der Lage ist, in der Harmonie ihrer Formen die Werte auszudrücken, die mit dem Konzept der minimalistischen Ästhetik verbunden sind. Mäßigung und Zurückhaltung sind das ausdrucksstarke Maß des recycelbaren Aluminiumdruckgusskörpers. Enthält einen integrierten Kühlkörper mit einer LED, um Leistung, Lichtqualität und Haltbarkeit zu gewährleisten. Das Beleuchtung ist diffus und umspült die Wand gleichmäßig.

AKI

La discreción es el privilegio de esta lámpara de pared que sabe expresar en la armonía de sus formas los valores asociados al concepto de estética minimalista. Moderación y sobriedad son la medida expresiva del cuerpo de aluminio reciclable fundido a presión. Incluye un disipador integrado con un LED para garantizar el rendimiento, la calidad de la luz y la durabilidad. La iluminación es difusa y baña uniformemente la pared.

AKI

Сдержанность - самая благородная черта этого настенного светильника, гармоничность форм которого олицетворяет ценности, связанные с концепцией эстетики минимализма. Сдержанность и строгость - именно в них таится сила экспрессии, которую несет в себе корпус из отлитого под давлением алюминия, пригодного для рециклинга. Комплектуется встроенным светодиодным рассеивателем, обеспечивающим высокую эффективность, качество освещения и долговечность. Рассеянный свет равномерно «омывает» стену.







AKI WALL



AKI WALL



AKI WALL

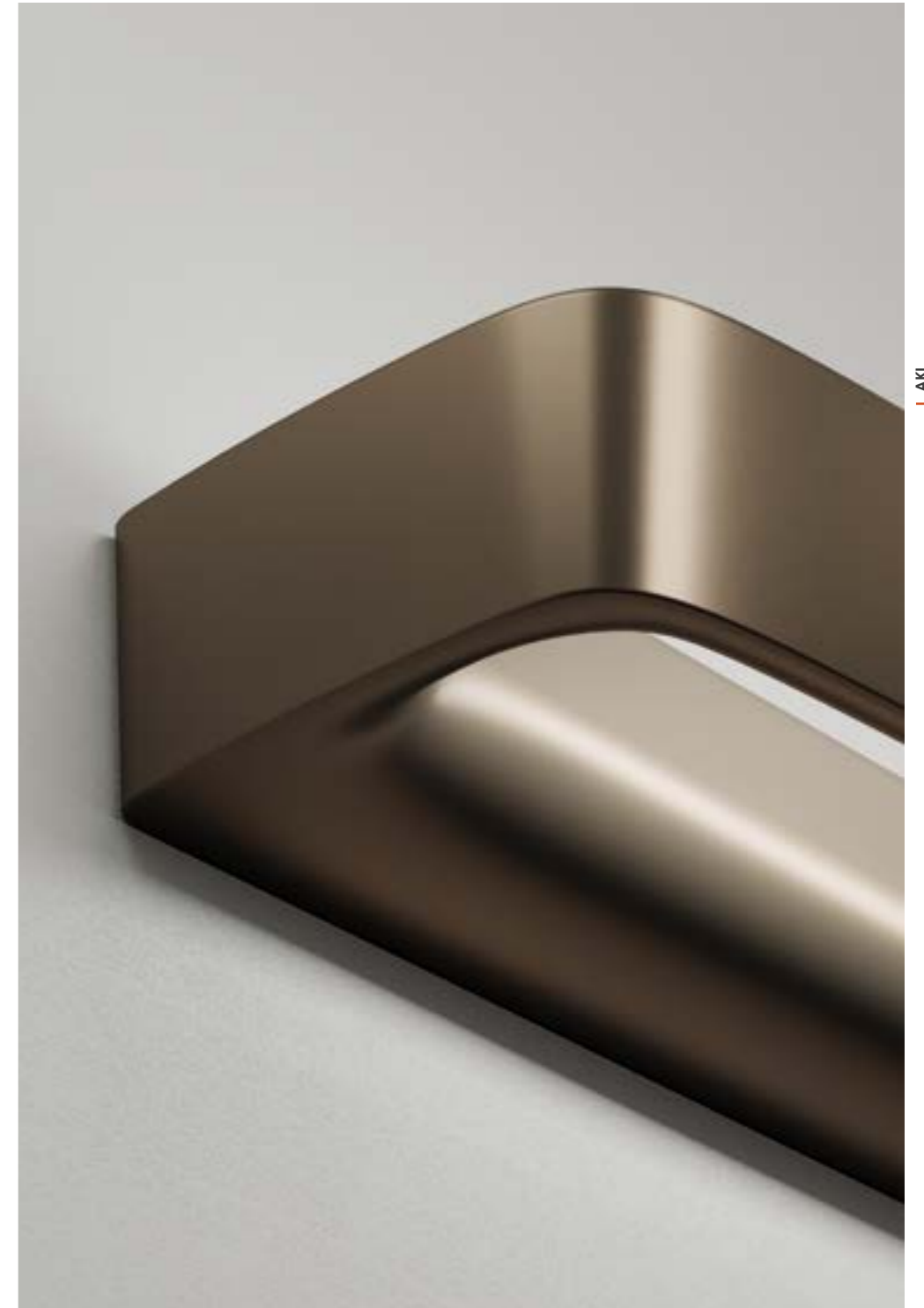



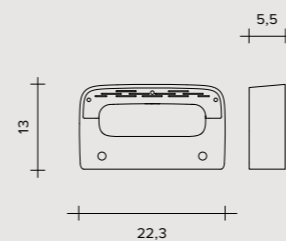

LED 11W
 2700°K / 1567 lumen
 3000°K / 1650 lumen
 4000°K / 1733 lumen
 CRI 90

Versions:

On-Off

Push

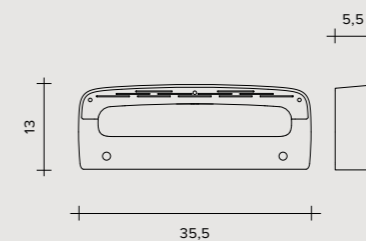

LED 22W
 2700°K / 3054 lumen
 3000°K / 3215 lumen
 4000°K / 3375 lumen
 CRI 90

Versions:

On-Off

Push

AKI Wall

Lampada da parete
 Wandleuchte
 Lámpara de pared
 Настенная лампа



FINISHES / FINITURE / FARBE / ACABADOS / ОТДЕЛКИ

- White / Bianco / Weiß / Blanco / Белый цвет
- Gold / Oro / Kupfe / Gold / Золото
- Copper / Rame / Kupfe / Cobre / Медь
- Bronze / Bronzo / Bronze / Bronce / бронза
- Anthracite grey / Antracite / Anthrazitfarben / Antracita / Антрацит

OLO

Marco Spatti

OLO

Light captured by aesthetics,
clean geometries and defined lines.
A wall lamp that knows how to
characterises an environment,
both on and off.
It is unobtrusive and fits
well in any interior.
Section changes, full and voids,
define the design lightly.
Even wall lighting.
One-of-a-kind die-cast
aluminium body.

WINNER



OLO

*Luce catturata dall'estetica,
geometrie pulite e linee definite,
una lampada da parete che sa
caratterizzare gli ambienti
sia accesa che spenta.
Non è intrusiva, si adatta
a qualsiasi interno.
I cambi di sezione, i pieni
e i vuoti, definiscono il design
con leggerezza.
L'illuminazione della parete
è uniforme. Il corpo realizzato
in pressofusione d'alluminio
è un pezzo unico.*

OLO

*Licht, eingefangen von Ästhetik,
klaren Geometrien und definierten
Linien, eine Wandleuchte,
die weiß, wie man Räume
charakterisiert sowohl an- als
auch ausgeschaltet.
Es ist unauffällig und passt
in jeden Innenraum.
Der Wechsel von Schnitten,
Körpern und Hohlräumen bestimmt
das Design mit Leichtigkeit.
Wandbeleuchtung ist einheitlich.
Das Gehäuse aus Aluminiumdruckguss
ist ein Unikat*

OLO

*Luz captada por la estética,
geometrías limpias y líneas
definidas, un aplique que sabe
caracterizar los ambientes
tanto encendido como apagado.
Es discreto y encaja en cualquier
ambiente interior.
Cambios de sección, sólidos
y vacíos, definen el diseño
con ligereza.
La iluminación de la pared
es uniforme. El cuerpo realizado
de aluminio fundido a presión
es una pieza única.*

OLO

*Свет, плененный эстетикой, чистыми
геометрическими формами и четкими
линиями: настенный светильник,
способный создавать
особую атмосферу в помещениях,
даже будучи выключенным.
Он не создает визуального шума и
вписывается в любой интерьер.
Меняющиеся сечения, игра полных
и пустых объемов формируют дизайн,
пронизанный ощущением легкости.
Стена освещается равномерным
образом. Монолитный корпус выполнен
из отлитого под давлением алюминия.*

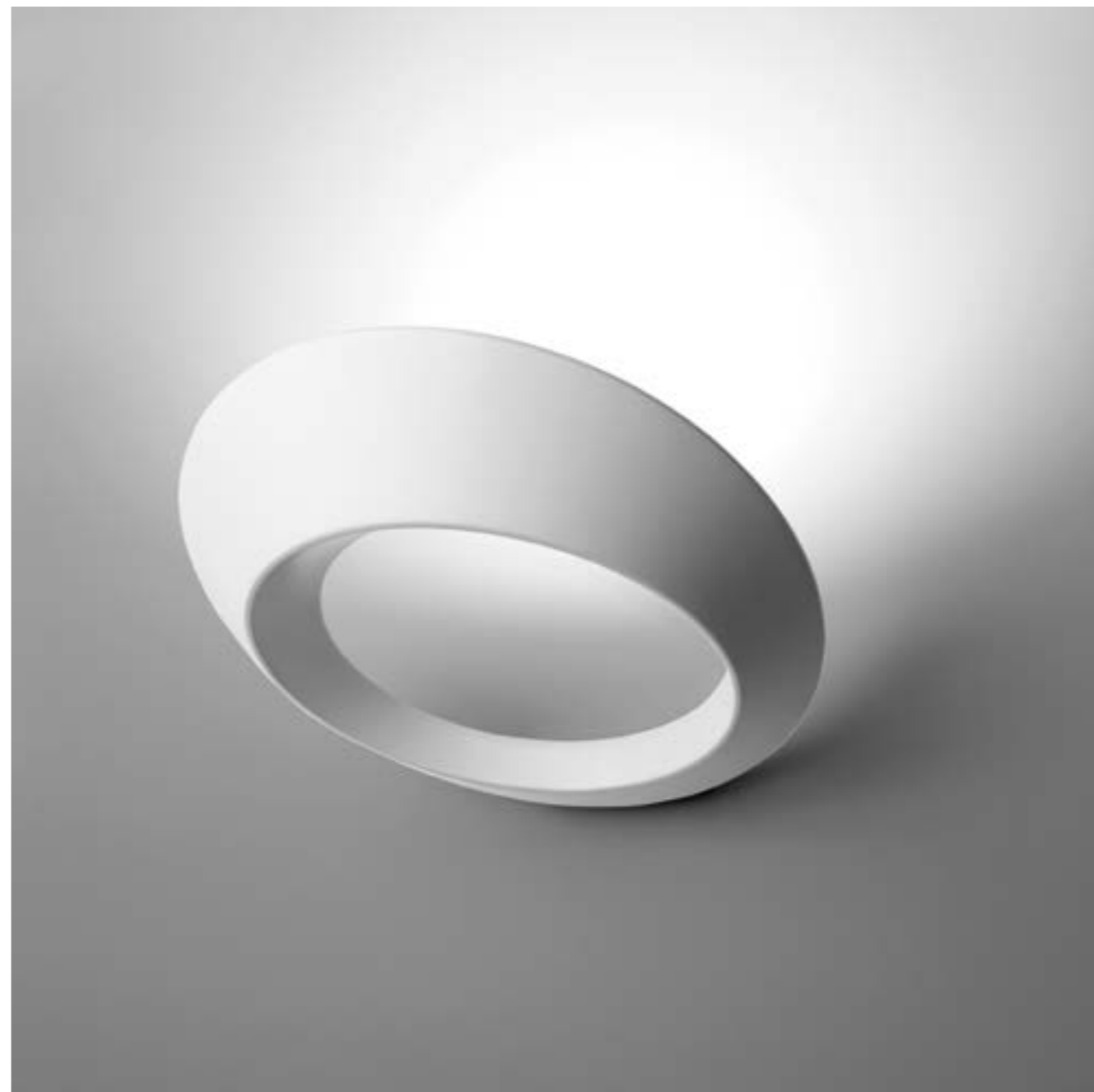







OLO WALL



OLO WALL





OLO WALL





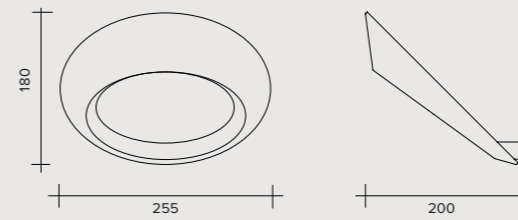

OLO

Wall

Lampada da parete

Wandleuchte

Lámpara de pared

Настенная лампа



FINISHES / FINITURE / FARBE / ACABADOS / ОТДЕЛКИ

- White / Bianco / Weiß / Blanco / Белый цвет
- Anthracite grey / Antracite / Anthrazitfarben / Antracita / Антрацит
- Brushed gold / Oro spazzolato / Gold gebürstet / Oro cepillado / Брашированное золото
- Brushed copper / Rame spazzolato / Kupfer gebürstet / Cobre cepillado / Брашированная медь
- Brushed bronze / Bronzo spazzolato / Bronze gebürstet / Bronce cepillado / Брашированная бронза

LIGHT SOURCE / SORGENTE / LICHTQUELLE / FUENTE LUMINOSA / ИСТОЧНИК СВЕТА

LED 33W - 230V 2700°K / 3085 lumen
 3000°K / 3300 lumen
 4000°K / 3515 lumen

RECOMMENDED DIMMER SWITCHES / DIMMER CONSIGLIATI / EMPFOHLENE DIMMER / REGULADORES DE INTENSIDAD ACONSEJADOS / РЕКОМЕНДУЕМЫЕ ДИММЕРЫ

code 1776.CASAMBI

Bluetooth dimmer, controls up to 4 lights, remote installation.
 Dimmer Bluetooth, gestisce fino a 4 lampade, installazione in remoto.
 Bluetooth-Dimmer, verwaltet bis zu 4 Lampen, Ferninstallation.
 Regulador de intensidad luminosa Bluetooth, para el control de hasta 4 lámparas, instalación a distancia.
 диммер bluetooth, позволяющий подключить до 4 ламп, удаленная установка.

code 1776.DIM

Phase cut dimmer, 230V AC, in/out, controls up to 6 lights, adjustable minimum setting, remote installation.
 Dimmer a taglio di fase 230vac, in/out, gestisce fino a 6 lampade, minimo programmabile, installazione in remoto.
 Phasendimmer 230Vac, Ein-/Ausgang, verwaltet bis zu 6 Lampen, Minimum programmierbar, Ferninstallation.
 Regulador de intensidad luminosa por corte de fase 230 Vca, in/out, para el control de hasta 6 lámparas, mínimo programable, instalación a distancia.
 диммер с отсечкой фазы 230В перем. тока, вход/выход, позволяющий подключить, до 6 ламп; минимальный уровень диммирования программируемый, удаленная установка.

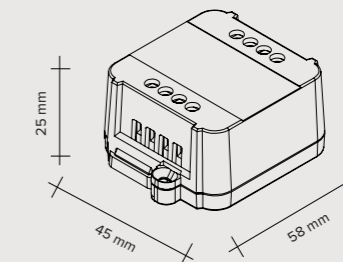
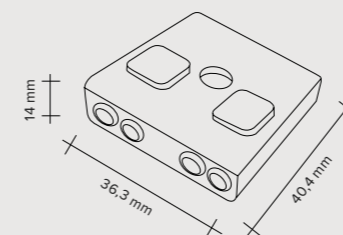

HOLE COVER / COPRIFORO / LOCHABDECKUNG / TAPAORIFICIO / ЗАГЛУШКА

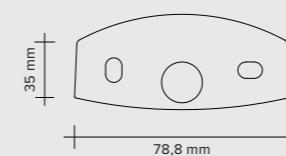

Wall hole cover plate in metal, painted white.
 Supplied standard, used for installations on walls with large sized holes.
 Piastrina copriforo parete in metallo, verniciata bianca. Fornita di serie, utile per installazioni su pareti con fori di grandi dimensioni.
 Lochabdeckung für Wände, aus Metall, weiß lackiert. Wird serienmäßig mitgeliefert und ist nützlich bei einer Installation an der Wand, wenn das Loch einen großen Durchmesser hat.
 Placa tapaorificio de metal para pared, pintada de blanco.
 Suministrada de serie, útil para instalaciones en paredes con orificios grandes.
 Металлическая накладка для покрытия настенных отверстий, окрашенная в белый цвет. Накладка входит в комплект поставки и хорошо подходит для установки на стены с отверстиями большого размера.

LINEA

blank design studio + Gerardo Mari

REGISTERED TRADEMARK, MODELLO REGISTRATO
GESCH. ZTETS MUSTER, MODELO REGISTRADO
ЗАРЕГИСТРИРОВАННАЯ МОДЕЛЬ

LINEA

Linearity is the philosophy of this product.

A system of flexible LED lighting elements with a harmonic steel core that reinvents the way light is experienced in an environment. Linea can be stretched between two opposing planes, mounted on the wall (wall/wall or wall/ceiling), installed directly with surface mounting or suspended to the ceiling. It can also be composed into free geometric shapes. The silicone cover evenly diffuses light, generated by two opposing LED strips with a combined output of up to 1900 lumens/metre.

WINNER



LINEA

La linearità è la filosofia del prodotto. Un sistema di elementi illuminanti flessibili a led con un'anima in acciaio armonico che reinventa il modo di vivere la luce negli ambienti. Linea può essere tesa tra due piani opposti, montabile sulla parete (parete/parete o parete/soffitto), installata direttamente con montaggio superficiale o può essere sospesa al soffitto e composta anche in forme geometriche libere. La copertura silconica diffonde in modo uniforme la luce, generata da due strip led contrapposte con resa combinata fino a 1900 lumen/metro.

LINEA

Linearität ist die Philosophie des Produkts. Ein System flexibler LED-Beleuchtungselemente mit einem harmonischen Stahlkern, das die Art und Weise Licht in Umgebungen zu erleben, neu erfindet. Linea kann zwischen zwei gegenüberliegenden Ebenen gespannt, an der Wand montiert (Wand/Wand oder Wand/Decke), direkt mit Oberflächenmontage installiert oder an der Decke aufgehängt und auch aus freien geometrischen Formen zusammengestellt werden. Die Silikonabdeckung sorgt für eine gleichmäßige Streuung des Lichts, das von zwei gegenüberliegenden LED-Streifen mit einer Gesamtleistung von bis zu 1900 Lumen/Meter erzeugt wird.

LINEA

La linealidad es la filosofía del producto. Un sistema de elementos de iluminación LED flexibles con un núcleo de acero armónico que reinventa la manera de experimentar la luz en los ambientes. Linea puede tensarse entre dos planos opuestos, montarse en la pared (pared/pared o pared/techo), instalarse directamente con montaje en superficie o puede suspenderse al techo e incluso en formas geométricas libres. La cubierta de silicona difunde uniformemente la luz, generada por dos tiras de LED opuestas con una potencia combinada de hasta 1900 lúmenes/metro.

LINEA

Философией изделия является линейность. Система гибких светодиодных световых элементов с сердечником из пружинной стали, которая представляет собой переосмысление концепции освещения помещений. Светильники Linea можно размещать между двумя противоположными плоскостями, закрепив на стене (стена/стена или стена/потолок); можно выполнить поверхностный монтаж или повесить светильник к потолку. Помимо этого, можно создавать различные композиции из геометрических фигур. Силиконовый кожух равномерно рассеивает свет, излучаемый двумя противоположными светодиодными лентами с суммарным световым потоком до 1900 люмен/метр.

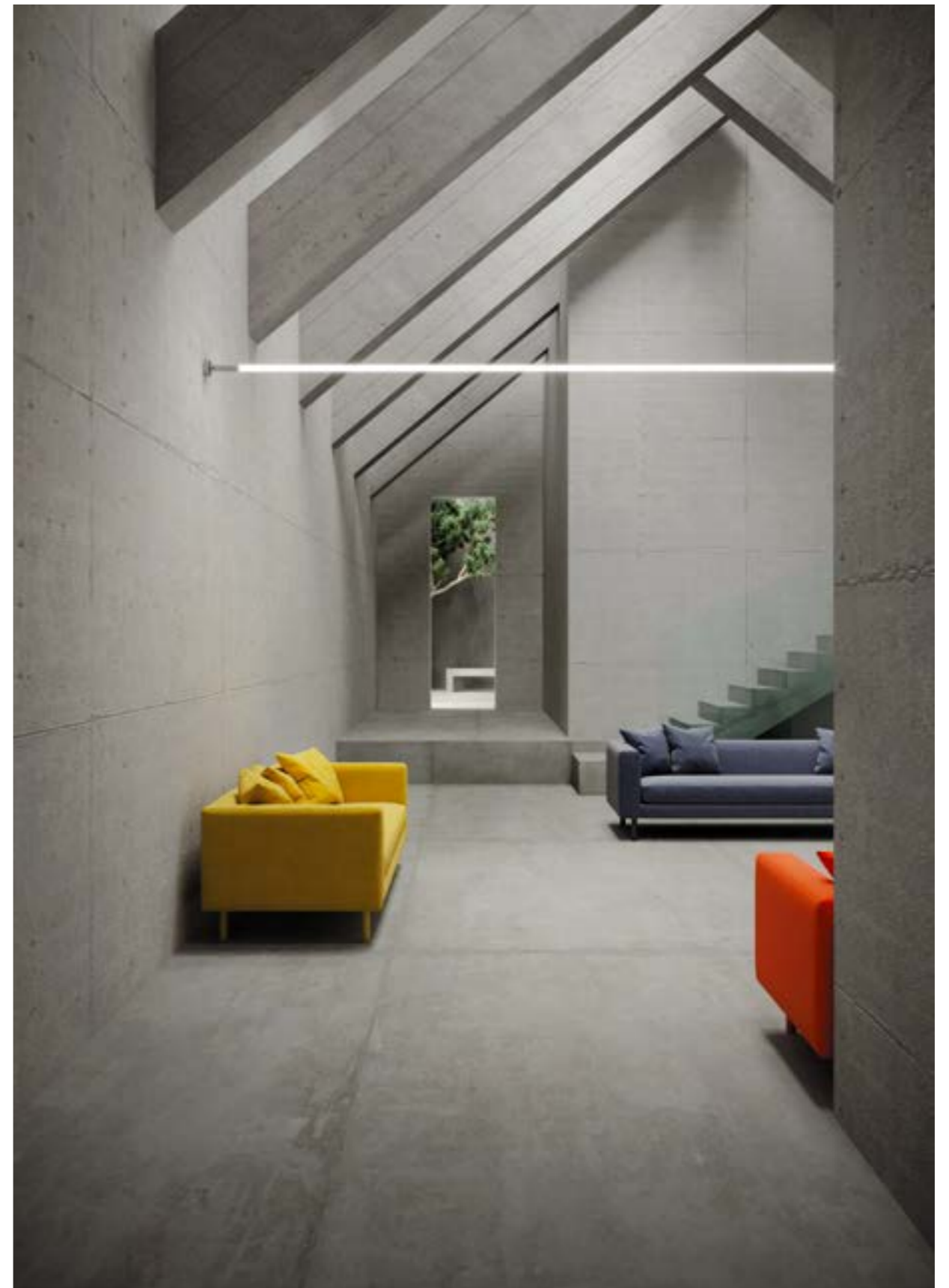



LINEA WALL-WALL







Wall-wall assembly

Installazione parete/parete / Wand/Wand Installation / Instalación pared/pared / Установка от стены до стены

Remote driver options

Opzioni con driver remoto
Optionen mit entfernt liegendem Driver
Opciones con driver remoto
Вариант с удаленным устройством управления

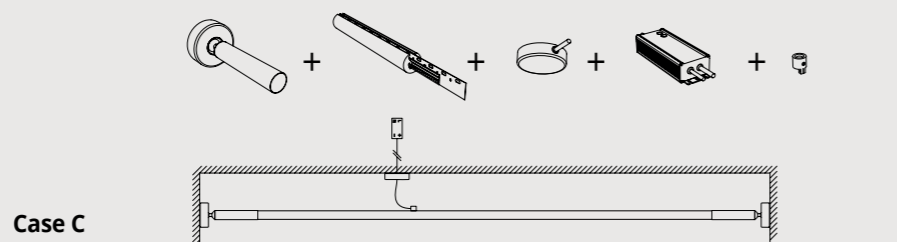
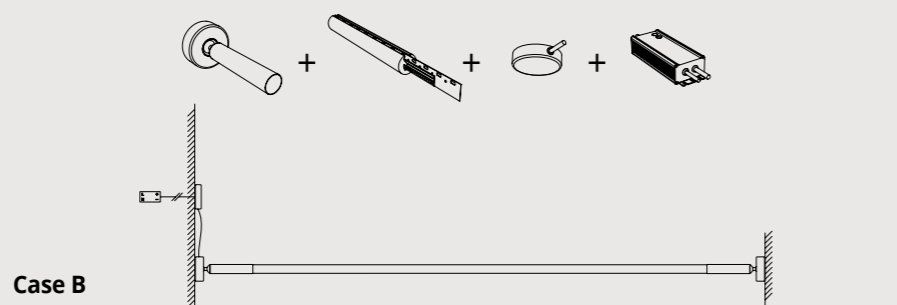
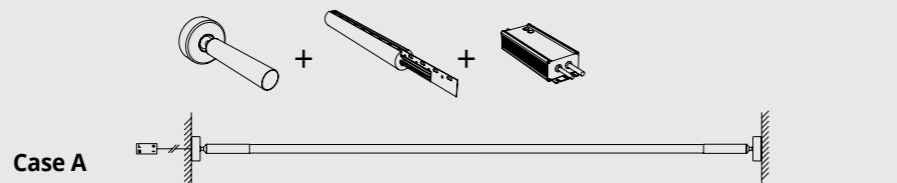

On-board driver options

Opzioni con driver a bordo
Optionen mit an der Einheit befindlichem Driver
Opciones con driver a bordo
Вариант со встроенным устройством управления

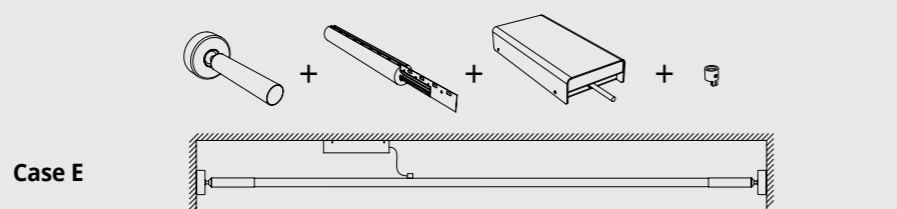
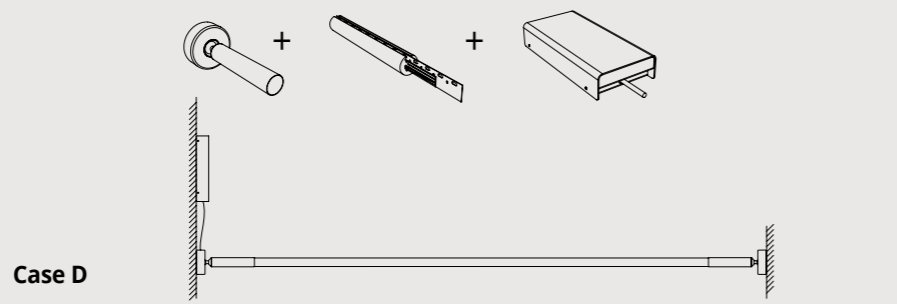

WALL-WALL / FLOOR-CEILING DIMENSIONS

Dimensione parete-parete / terra-soffitto
Abmessungen wand-wand / boden-decke
Medida pared-pared / suelo-techo
Версия от стены до стены / от пола до потолка

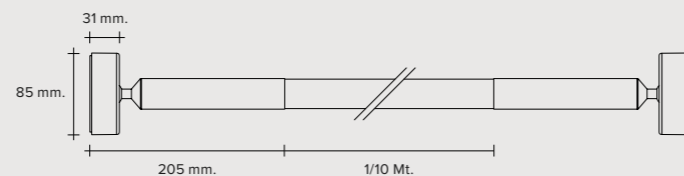

LINEA

System

LED linear lighting system
Sistema di illuminazione lineare a Led
Lineares LED-Beleuchtungssystem
El sistema de iluminación lineal de led
Линейная светодиодная осветительная система

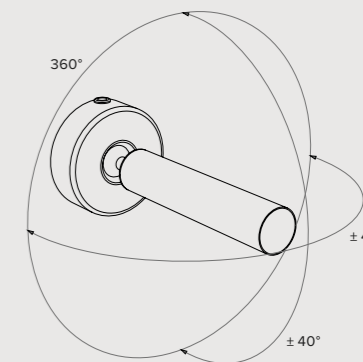

FINISHES / FINITURE / FARBE / ACABADOS / ОТДЕЛКИ

FRAME - CANOPIES - DRIVER BOX

Montatura - Rosoni - Driver Box / Gestell - Baldachin - Driver Box / Estructura - Florones - Driver Box
Отделка - Основания светильника - светодиодные драйверы

- Brushed aluminium / Alluminio spazzolato / Gebürstetes Aluminium / Aluminio cepillado / Крацованный алюминий
- Black / Nero / Schwarz / Negro / Чёрный цвет
- Sand / Sabbia / Sandfarben / Arena / Песочный цвет

DIFFUSER

Diffusore / Diffusorabdeckung / Difusor / Рассеиватель

- White opaline silicone / Silicone bianco opalino / Weiß opalfarben silikon / Silicona blanca opalin / Белый молочный силикон

LIGHT SOURCE / SORGENTE / LICHTQUELLE / FUENTE LUMINOSA / ИСТОЧНИК СВЕТА

1 m.	LED 20W	48V	2700°K / 1700 Lumen	CRI 90	6 m.	LED 120W	48V	2700°K / 10200 Lumen	CRI 90
			3000°K / 1900 Lumen	CRI 90				3000°K / 11400 Lumen	CRI 90
2 m.	LED 40W	48V	2700°K / 3400 Lumen	CRI 90	7 m.	LED 140W	48V	2700°K / 11900 Lumen	CRI 90
			3000°K / 3800 Lumen	CRI 90				3000°K / 13300 Lumen	CRI 90
3 m.	LED 60W	48V	2700°K / 5100 Lumen	CRI 90	8 m.	LED 160W	48V	2700°K / 13600 Lumen	CRI 90
			3000°K / 5700 Lumen	CRI 90				3000°K / 15200 Lumen	CRI 90
4 m.	LED 80W	48V	2700°K / 6800 Lumen	CRI 90	9 m.	LED 180W	48V	2700°K / 15300 Lumen	CRI 90
			3000°K / 7600 Lumen	CRI 90				3000°K / 17100 Lumen	CRI 90
5 m.	LED 100W	48V	2700°K / 8500 Lumen	CRI 90	10 m.	LED 200W	48V	2700°K / 17000 Lumen	CRI 90
			3000°K / 9500 Lumen	CRI 90				3000°K / 19000 Lumen	CRI 90

DRIVER BOX L

xxxx.B3
xxxx.B5
xxxx.B6

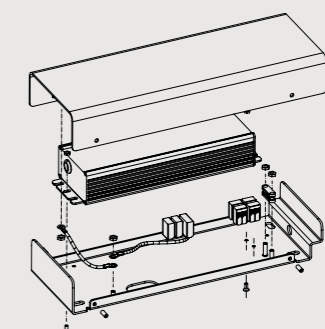
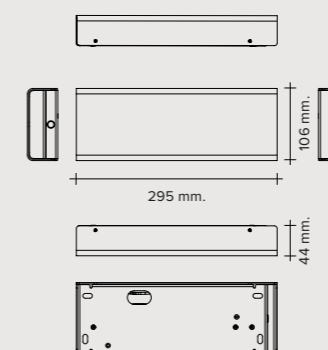

DRIVER BOX S

xxxx.B1
xxxx.B2
xxxx.B4

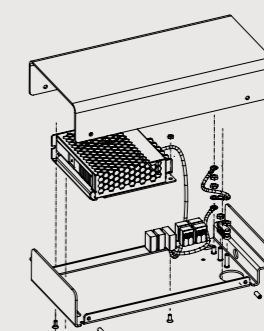
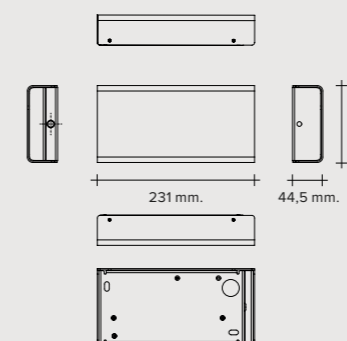

CANOPY

xxxx.M4



* Power cable: 1,2 m.
Cavo di alimentazione: 1,2 m. / Stromversorgungskabel: 1,2 m. / Cable de alimentación: 1,2 m. / Шнур питания: 1,2 m.

See codes and prices from page to page / Vedi codici e prezzi da pag a pag. / Artikelnummern und Preise siehe Seite bis Seite
Véanse códigos y precios desde pág. hasta pág. / См. коды и цены от страницы до страницы



LINEA

SURFACE MOUNTING





LINEA SURFACE MOUNTING



LINEA

SURFACE MOUNTING



Surface mounting

Installazione superficiale / Aufputz-Installation / Instalación en superficie / Установка на поверхность стены или потолка

Remote driver options

Opzioni con driver remoto
 Optionen mit entfernt liegendem Driver
 Opciones con driver remoto
 Вариант с удаленным устройством управления

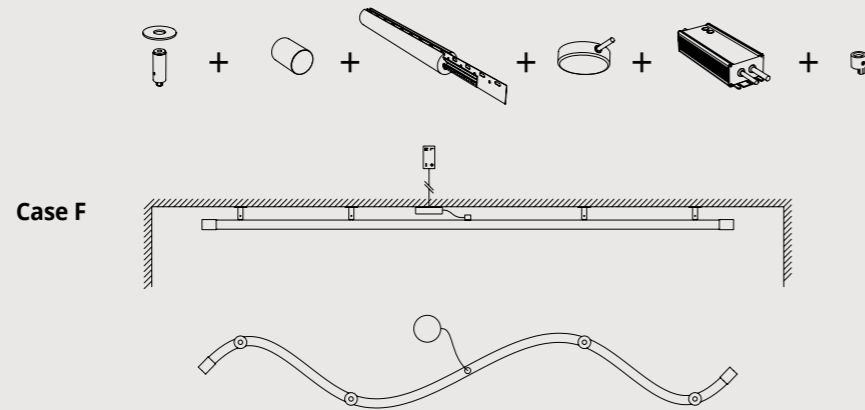

On-board driver options

Opzioni con driver a bordo
 Optionen mit an der Einheit befindlichem Driver
 Opciones con driver a bordo
 Вариант со встроенным устройством управления

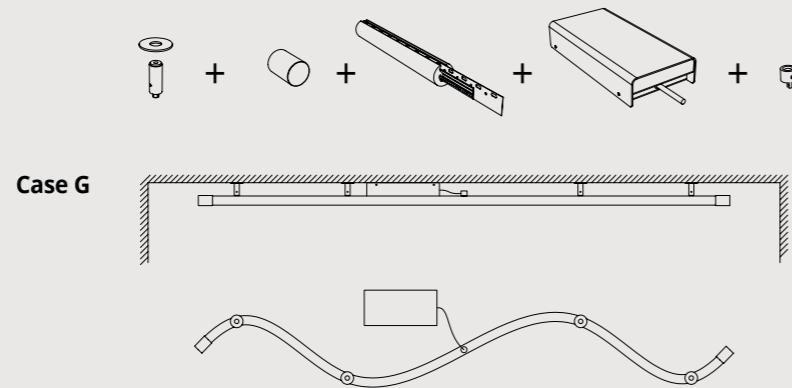

WALL / CEILING DIMENSIONS

Dimensione parete / soffitto
 Abmessungen wand/decke
 Medidas pared / techo
 Версия стена / потолок

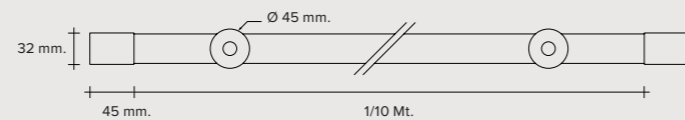

* Power cable: 1,5 m.

Cavo di alimentazione: 1,5 m. / Stromversorgungskabel: 1,5 m. / Cable de alimentación: 1,5 m. / Шнур питания: 1,5 m.

IF YOU NEED THE FOLLOWING TYPES OF INSTALLATIONS PLEASE SHARE WITH US SIZE A WHEN ORDERING

Nei seguenti casi di installazione comunicare la misura A al momento dell'ordine / In den folgenden Installationssituationen bitte bei der Bestellung das Maß A mitteilen / En los siguientes casos de instalación al hacer el pedido es necesario comunicar la medida A / В следующих случаях при размещении заказа следует сообщить размер A

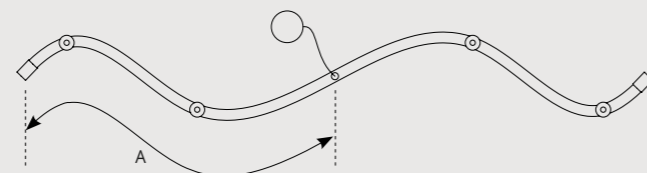

LINEA

System

LED linear lighting system
 Sistema di illuminazione lineare a Led
 Lineares LED-Beleuchtungssystem
 El sistema de iluminación lineal de led
 Линейная светодиодная осветительная система



FINISHES / FINITURE / FARBE / ACABADOS / ОТДЕЛКИ

FRAME - CANOPIES - DRIVER BOX

Montatura - Rosoni - Driver Box / Gestell - Baldachin - Driver Box / Estructura - Florones - Driver Box
 Отделка - Основания светильника - светодиодные драйверы

- Brushed aluminium / Alluminio spazzolato / Gebürstetes Aluminium / Aluminio cepillado / Крацованный алюминий
- Black / Nero / Schwarz / Negro / Чёрный цвет
- Sand / Sabbia / Sandfarben / Arena / Песочный цвет

DIFFUSER

Diffusore / Diffusorabdeckung / Difusor / Рассеиватель

- White opaline silicone / Silicone bianco opalino / Weiß opalfarben silikon / Silicona blanca opalin / Белый молочный силикон

LIGHT SOURCE / SORGENTE / LICHTQUELLE / FUENTE LUMINOSA / ИСТОЧНИК СВЕТА

1 m.	LED 20W	48V	2700°K / 1700 Lumen	CRI 90	6 m.	LED 120W	48V	2700°K / 10200 Lumen	CRI 90
			3000°K / 1900 Lumen	CRI 90				3000°K / 11400 Lumen	CRI 90
2 m.	LED 40W	48V	2700°K / 3400 Lumen	CRI 90	7 m.	LED 140W	48V	2700°K / 11900 Lumen	CRI 90
			3000°K / 3800 Lumen	CRI 90				3000°K / 13300 Lumen	CRI 90
3 m.	LED 60W	48V	2700°K / 5100 Lumen	CRI 90	8 m.	LED 160W	48V	2700°K / 13600 Lumen	CRI 90
			3000°K / 5700 Lumen	CRI 90				3000°K / 15200 Lumen	CRI 90
4 m.	LED 80W	48V	2700°K / 6800 Lumen	CRI 90	9 m.	LED 180W	48V	2700°K / 15300 Lumen	CRI 90
			3000°K / 7600 Lumen	CRI 90				3000°K / 17100 Lumen	CRI 90
5 m.	LED 100W	48V	2700°K / 8500 Lumen	CRI 90	10 m.	LED 200W	48V	2700°K / 17000 Lumen	CRI 90
			3000°K / 9500 Lumen	CRI 90				3000°K / 19000 Lumen	CRI 90

DRIVER BOX L

xxxx.B3
 xxxx.B5
 xxxx.B6

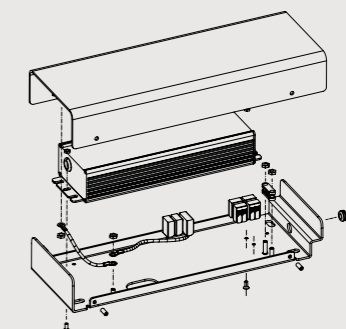
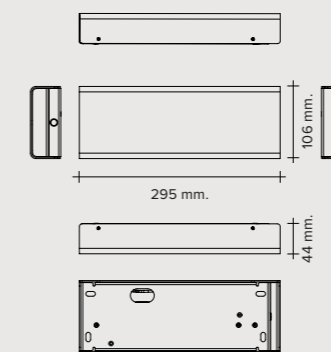

DRIVER BOX S

xxxx.B1
 xxxx.B2
 xxxx.B4

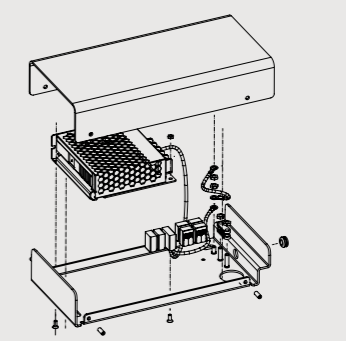
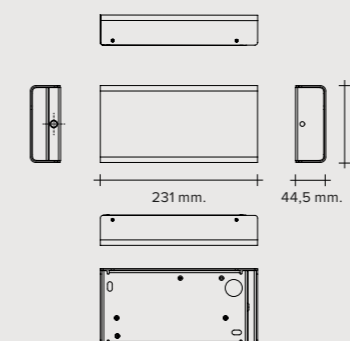

CANOPY

xxxx.M4



See codes and prices from page to page / Vedi codici e prezzi da pag. a pag. / Artikelnummern und Preise siehe Seite bis Seite
 Véanse códigos y precios desde pag. hasta pag. / См. коды и цены от страницы до страницы

338 - 339 - 340 - 341

LINEA

VERTICAL SUSPENSION



LINEA

Suspended installation

Installazione a sospensione / Installation als Hängeleuchte / Instalación de suspensión / Подвесная установка

Vertical assembly

Montaggio verticale
Vertikale Montage
Montaje vertical
Вертикальная установка

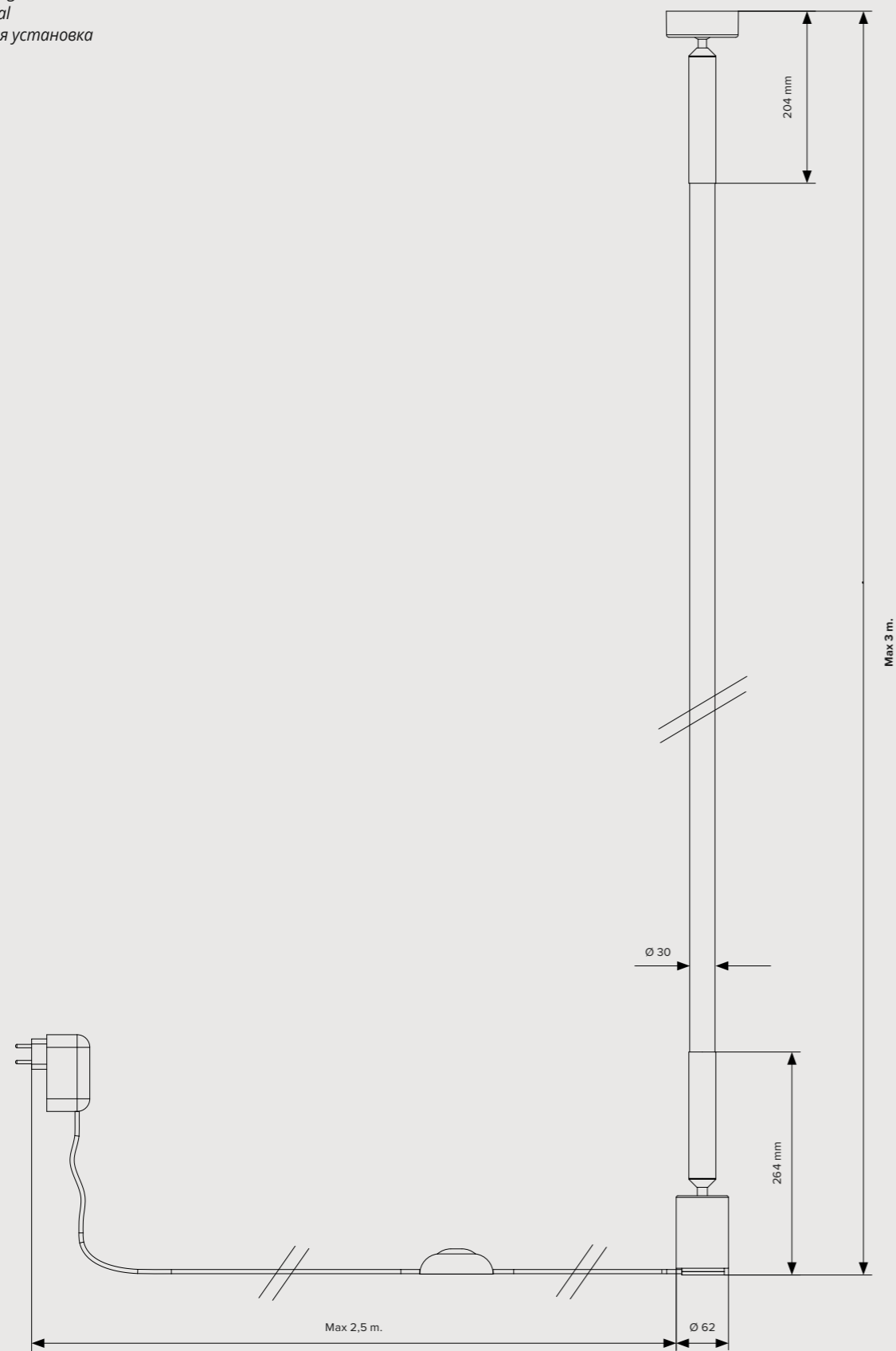

LINEA

System

LED linear lighting system
Sistema di illuminazione lineare a Led
Lineares LED-Beleuchtungssystem
El sistema de iluminación lineal de led
Линейная светодиодная осветительная система



FINISHES / FINITURE / FARBE / ACABADOS / ОТДЕЛКИ

FRAME

Montatura / Gestell / Estructura / Отделка

- Brushed aluminium / Alluminio spazzolato / Gebürstetes Aluminium / Aluminio cepillado / Крацованный алюминий
- Black / Nero / Schwarz / Negro / Чёрный цвет
- Sand / Sabbia / Sandfarben / Arena / Песочный цвет

DIFFUSER

Diffusore / Diffusorabdeckung / Difusor / Рассеиватель

- White opaline silicone / Silicone bianco opalino
Weiß opalfarben silikon / Silicona blanca opalina / Белый молочный силикон

LIGHT SOURCE / SORGENTE / LICHTQUELLE / FUENTE LUMINOSA / ИСТОЧНИК СВЕТА

3 m.	LED 60W	48V *	2700°K / 5100 Lumen	CRI 90
			3000°K / 5700 Lumen	CRI 90

* Dimmable - Foot-dimmable. Plug connector

Dimmerabile. Dimmer a piede. Alimentatore a spina
Dimmbar - Fußdimmer. Steckernetzteil
Atenuable - Regulador de intensidad de pie. Fuente de alimentación con enchufe
С регулируемой яркостью - Педальный диммер. Штепсельный блок питания.

LINEA HORIZONTAL SUSPENSION





LINEA

HORIZONTAL SUSPENSION





Suspended installation

Installazione a sospensione / Installation als Hängeleuchte / Instalación de suspensión / Подвесная установка

Horizontal assembly
 Montaggio orizzontale
 Horizontale Montage
 Montaje horizontal
 Горизонтальный монтаж

S1

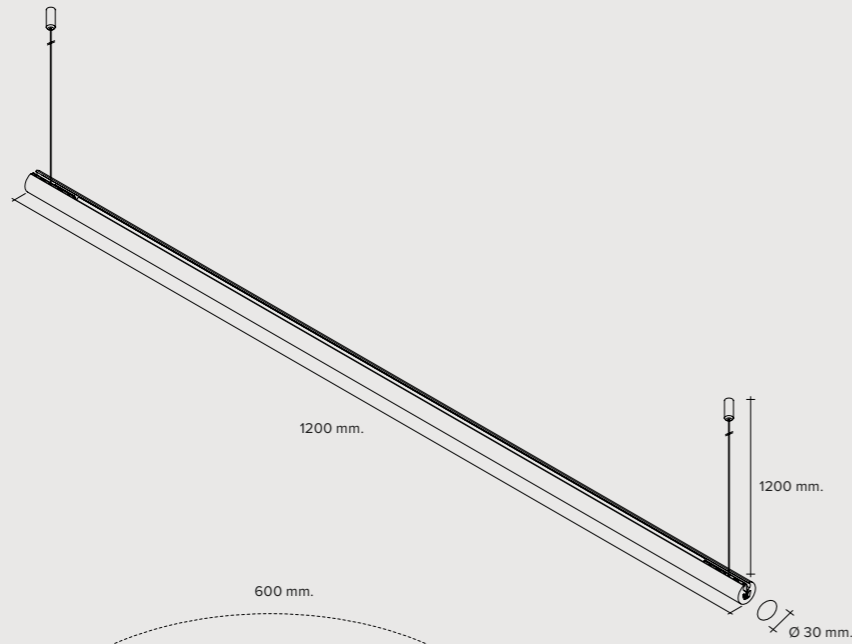

S2

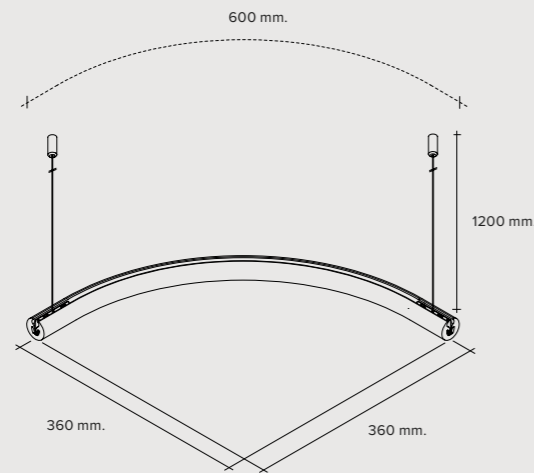

S3

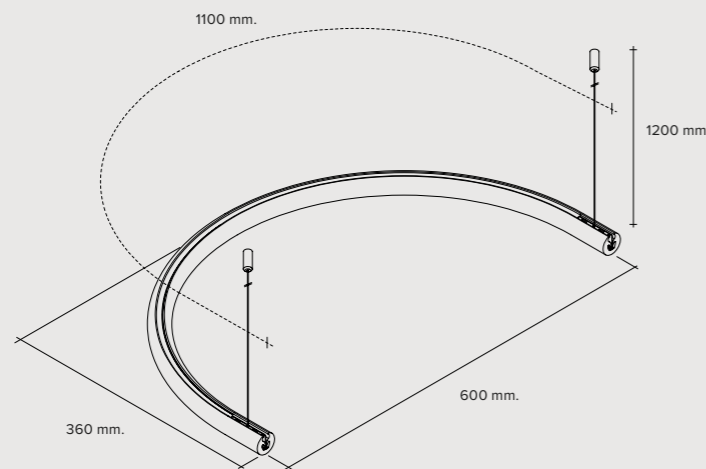

* Power cable: 2 m. Steel core elements cannot be cut to measure

Cavo di alimentazione: 2 m. Elementi con anima in acciaio non sezionabili a misura

Stromversorgungskabel: 2 m. Elemente mit Stahlkern, die nicht auf Maß geschnitten werden können

Cable de alimentación: 2 m. Elementos con núcleo de acero, no pueden cortarse a medida

Шнур питания: 2 м. Элементы со стальным сердечником, резка по индивидуальному размеру невозможна.

LINEA

System

LED linear lighting system

Sistema di illuminazione lineare a Led

Lineares LED-Beleuchtungssystem

El sistema de iluminación lineal de led

Линейная светодиодная осветительная система



FINISHES / FINITURE / FARBE / ACABADOS / ОТДЕЛКИ

FRAME - CANOPIES - DRIVER BOX

Montatura - Rosoni - Driver Box / Gestell - Baldachin - Driver Box / Estructura - Florones - Driver Box

Отделка - Основания светильника - светодиодные драйверы

- Brushed aluminium / Alluminio spazzolato / Gebürstetes Aluminium / Aluminio cepillado / Крацованный алюминий
- Black / Nero / Schwarz / Negro / Чёрный цвет
- Sand / Sabbia / Sandfarben / Arena / Песочный цвет

DIFFUSER

Diffusore / Diffusorabdeckung / Difusor / Рассеиватель

- White opaline silicone / Silicone bianco opalino / Weiß opalfarben silikon / Silicona blanca opalin / Белый молочный силикон

LIGHT SOURCE / SORGENTE / LICHTQUELLE / FUENTE LUMINOSA / ИСТОЧНИК СВЕТА

Model	Power	Voltage	Color Temperature	Lumen	CRI
S1	LED 24W	48V	2700°K	2040 Lumen	CRI 90
			3000°K	2280 Lumen	CRI 90
S2	LED 12W	48V	2700°K	1020 Lumen	CRI 90
			3000°K	1140 Lumen	CRI 90
S3	LED 22W	48V	2700°K	1870 Lumen	CRI 90
			3000°K	2090 Lumen	CRI 90

DRIVER BOX L

xxxx.B3
 xxxx.B5
 xxxx.B6

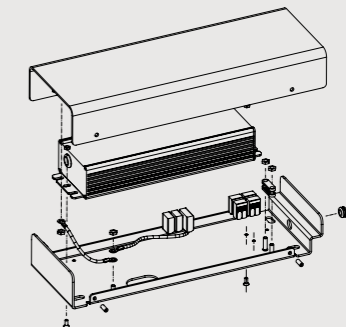
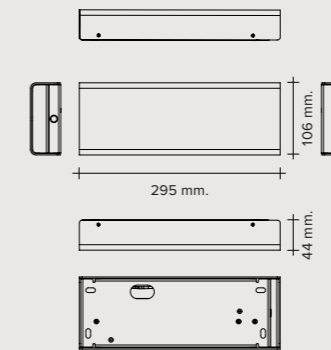

DRIVER BOX S

xxxx.B1
 xxxx.B2
 xxxx.B4

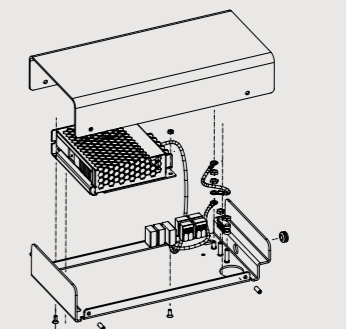
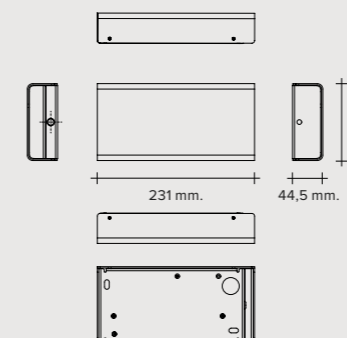

CANOPIE

xxxx.M4



Ø 85

See codes and prices from page to page / Vedi codici e prezzi da pag. a pag. / Artikelnummern und Preise siehe Seite bis Seite
 Véanse códigos y precios desde pag. hasta pag. / См. коды и цены от страницы до страницы

Settings and components

Configurazione e componenti / Konfigurationen und Komponenten / Configuraciones y componentes / Компоновка и детали

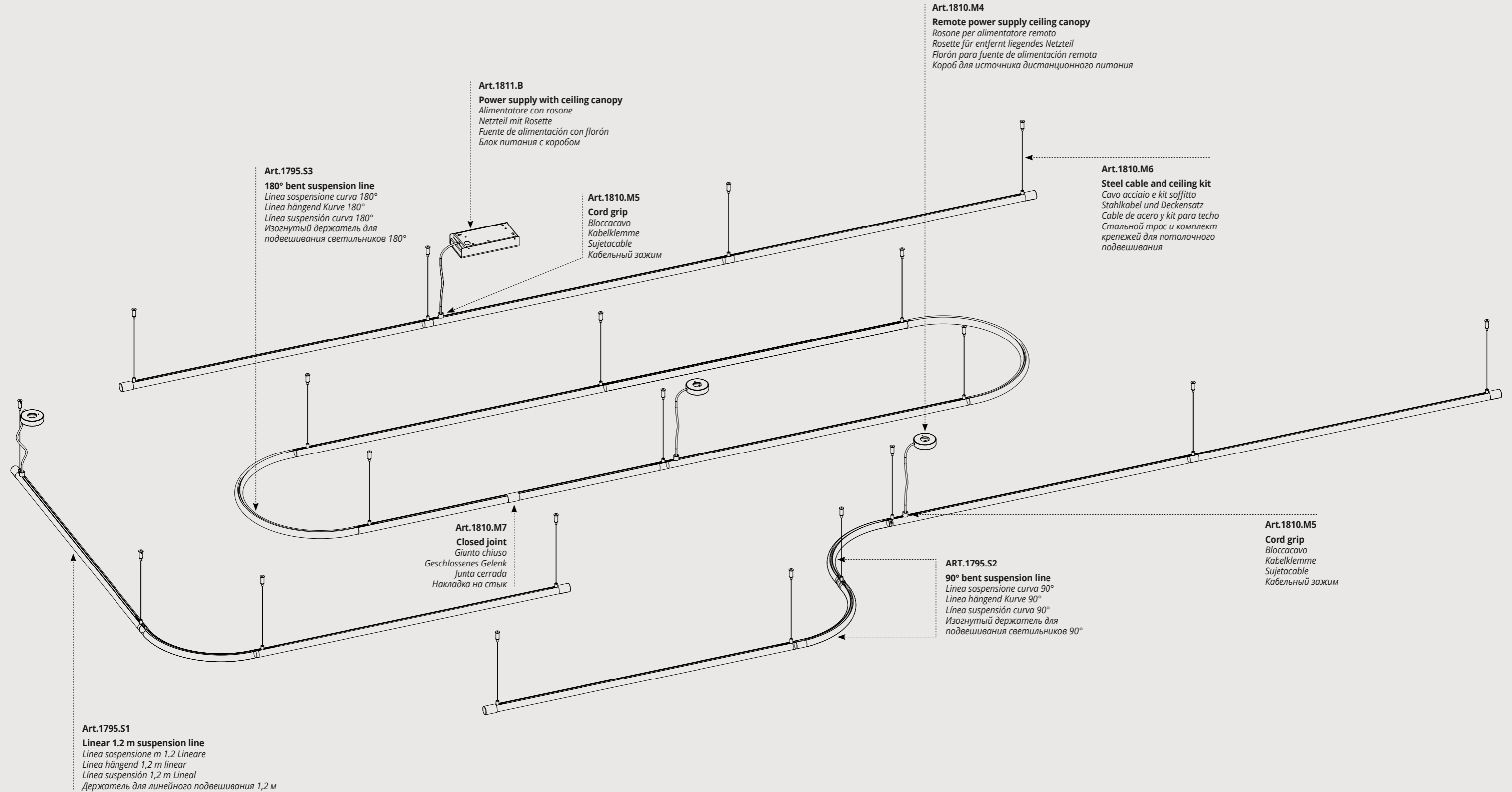

LAMOI

Andrea Barra

LAMOI

The light that amazes, fascinates and involves is a theme that the Lamoi LED lamp series interprets with ethereal personality. The current-conducting metal powers and switches on the 1w LED modules. Available in the 2700°K and 3000°K versions. Dimmable and non-dimmable, with or without covers.

LAMOI

La luce che stupisce, affascina e coinvolge è un tema che la serie di lampade a led, Lamoi interpreta con eterea personalità. Il metallo conduttore di corrente alimenta e accende i moduli led da 1 w. Disponibili in 2700°K e 3000°K. Dimmerabile e non, con o senza coperture.

LAMOI

Licht, das erstaunt, fasziniert und mitreißt, ist ein Thema, das die LED-Lampenserie Lamoi mit ätherischer Persönlichkeit interpretiert. Das stromleitende Metall versorgt die 1-W-LED-Module mit Strom und schaltet sie ein. Erhältlich in 2700°K und 3000°K. Dimmbar und nicht dimmbar, mit oder ohne Abdeckung.

LAMOI

La luz que asombra, fascina y envuelve es un tema que la serie de lámparas LED, Lamoi, interpreta con personalidad etérea. El metal conductor de corriente alimenta y enciende los módulos LED de 1 w. Disponible en 2700°K y 3000°K. Regulable y no regulable, con o sin cubiertas.

LAMOI

Свет, который удивляет, завораживает и привлекает: серия светодиодных светильников Lamoi предлагает интерпретацию этой темы, несущую на себе печать воздушной оригинальности. Токпроводящий металл подает питание на светодиодные модули мощностью 1 Вт. Доступны варианты 2700°K и 3000°K. Версии с диммером и без него, с крышками и без.





LAMOI SUSPENSION

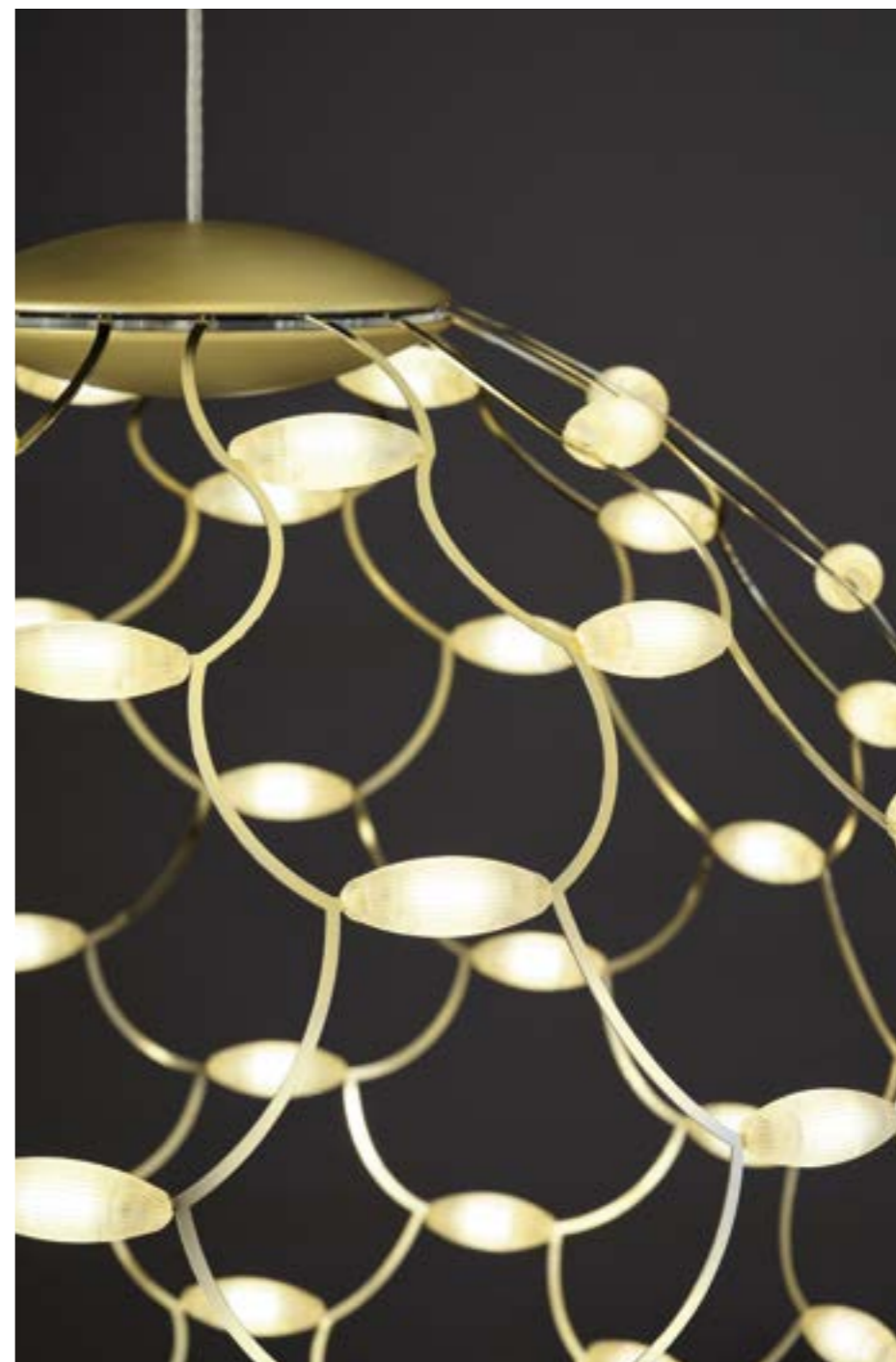

LAMOI SUSPENSION

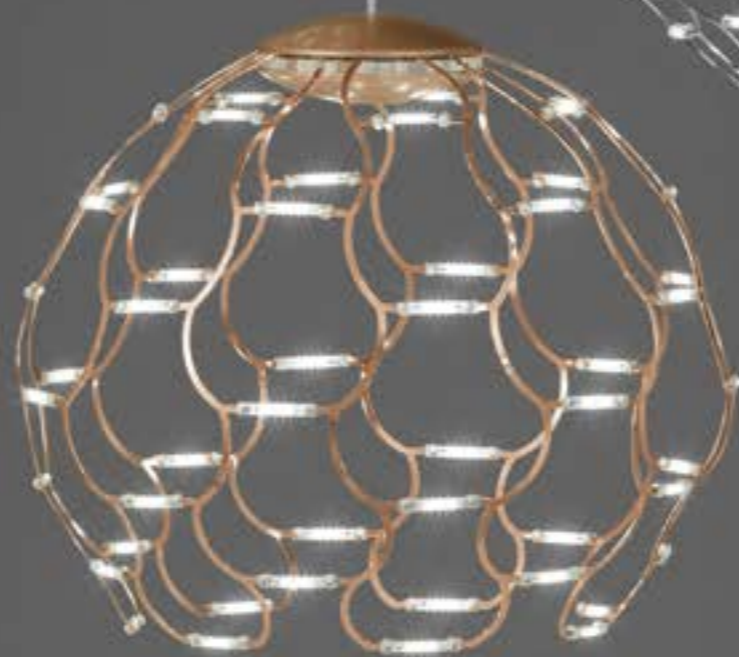
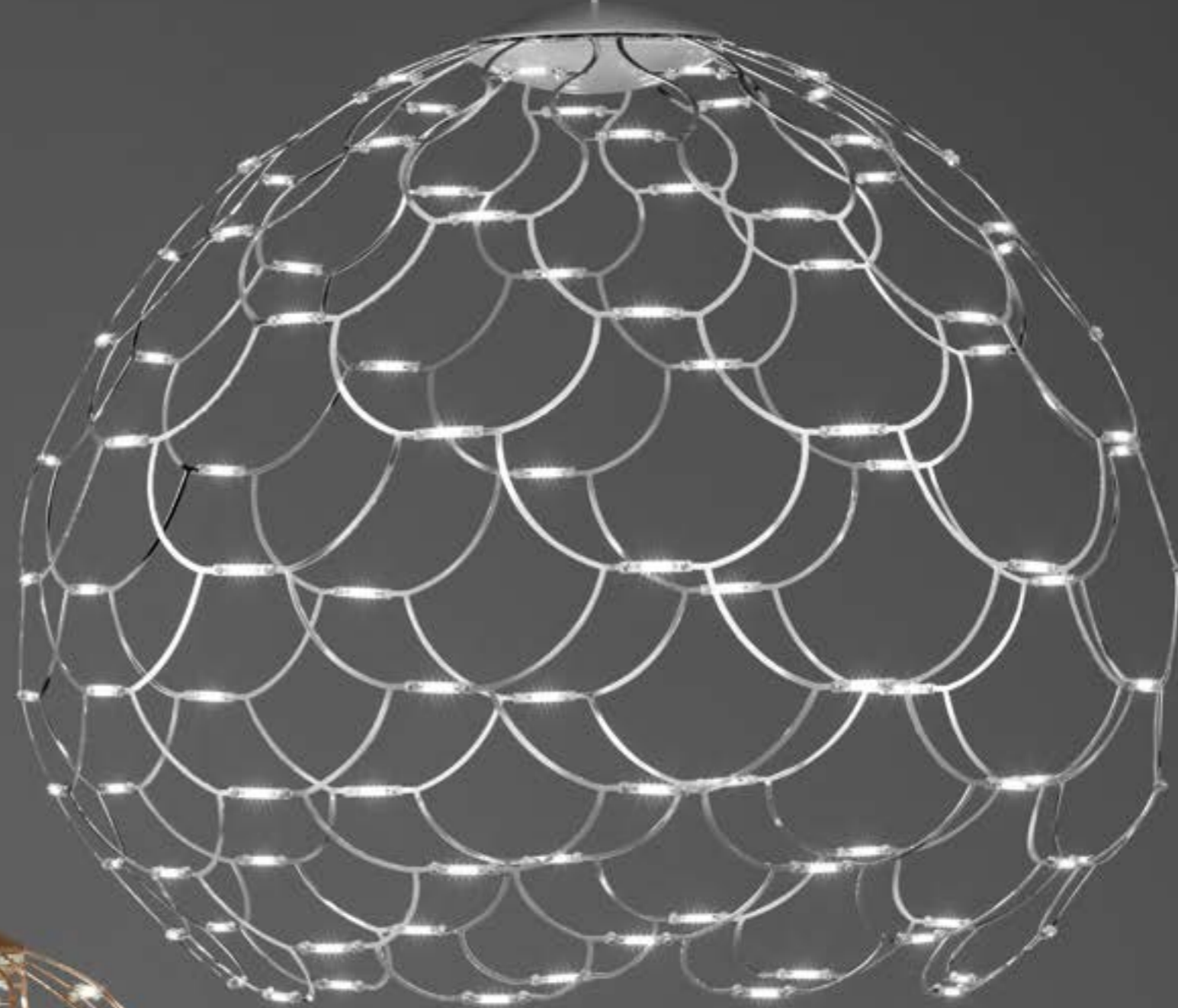



LAMOI

SUSPENSION



LAMOI 2.0 SUSPENSION



LAMOI 2.0 SUSPENSION

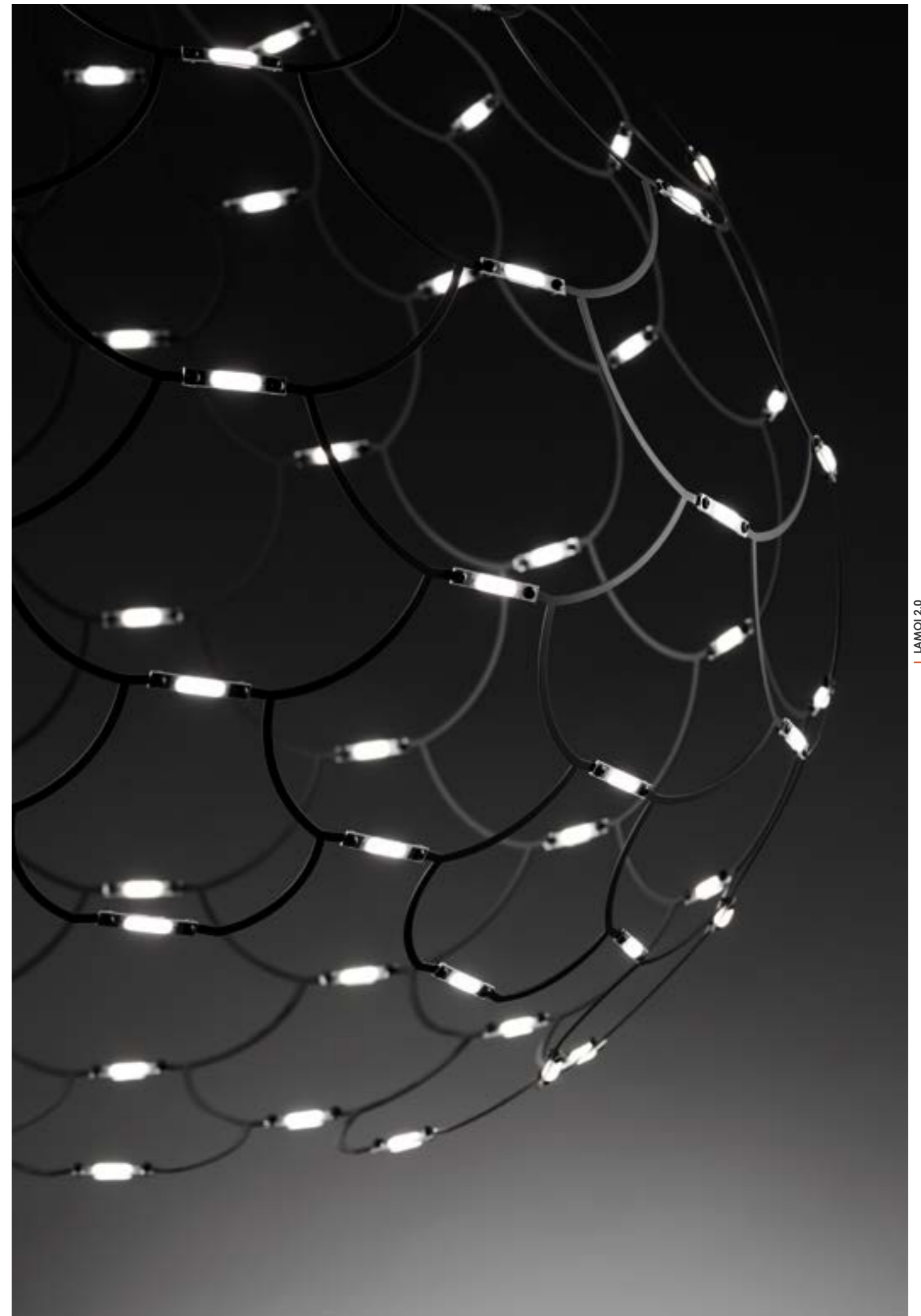

LAMOI 2.0 SUSPENSION



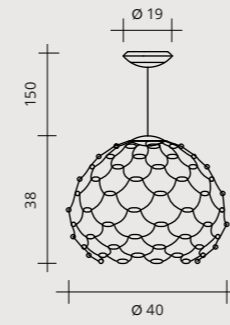

LED 49W - 24V
2700°K / 5468 lumen
3000°K / 6076 lumen

Versions:

On-Off

Push
Dali
0-10v
1-10v

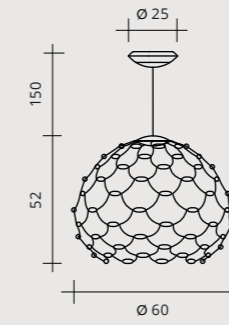

LED 72W - 24V
2700°K / 8035 lumen
3000°K / 8928 lumen

Versions:

On-Off

Push
Dali
0-10v
1-10v

Triac

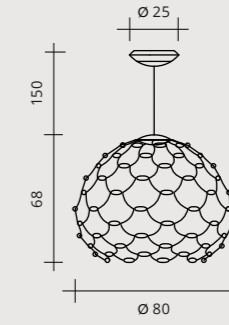

LED 99W - 24V
2700°K / 9939 lumen
3000°K / 11044 lumen

Versions:

On-Off

Push
Dali
0-10v
1-10v

LAMOI Suspension

Lampada a sospensione
Pendelleuchte
Lámpara colgante
Подвесная лампа



FINISHES / FINITURE / FARBE / ACABADOS / ОТДЕЛКИ

- Copper / Rame / Kupfe / Cobre / Медь
- Chrome / Cromo / Chrom / Cromo / Хром
- Gold / Oro / Kupfe / Gold / Золото

LAMOI 2.0 Suspension

Lampada a sospensione
Pendelleuchte
Lámpara colgante
Подвесная лампа



FINISHES / FINITURE / FARBE / ACABADOS / ОТДЕЛКИ

- Matt black / Nero opaco / Mattschwarz / Negro mate / Матовый черный/ве

See codes and prices from page to page / Vedi codici e prezzi da pag a pag. / Artikelnummern und Preise siehe Seite bis Seite
Véanse códigos y precios desde pág. hasta pág. / См. коды и цены от страницы до страницы

346 - 347 - 350



LAMOI CEILING

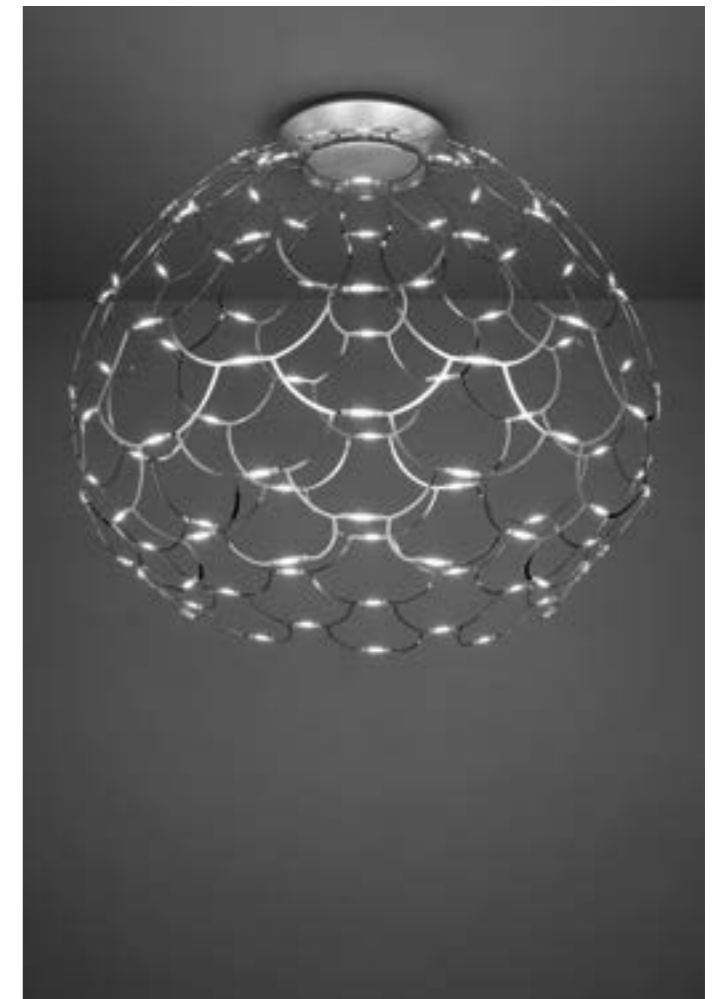



LAMOI 2.0 CEILING

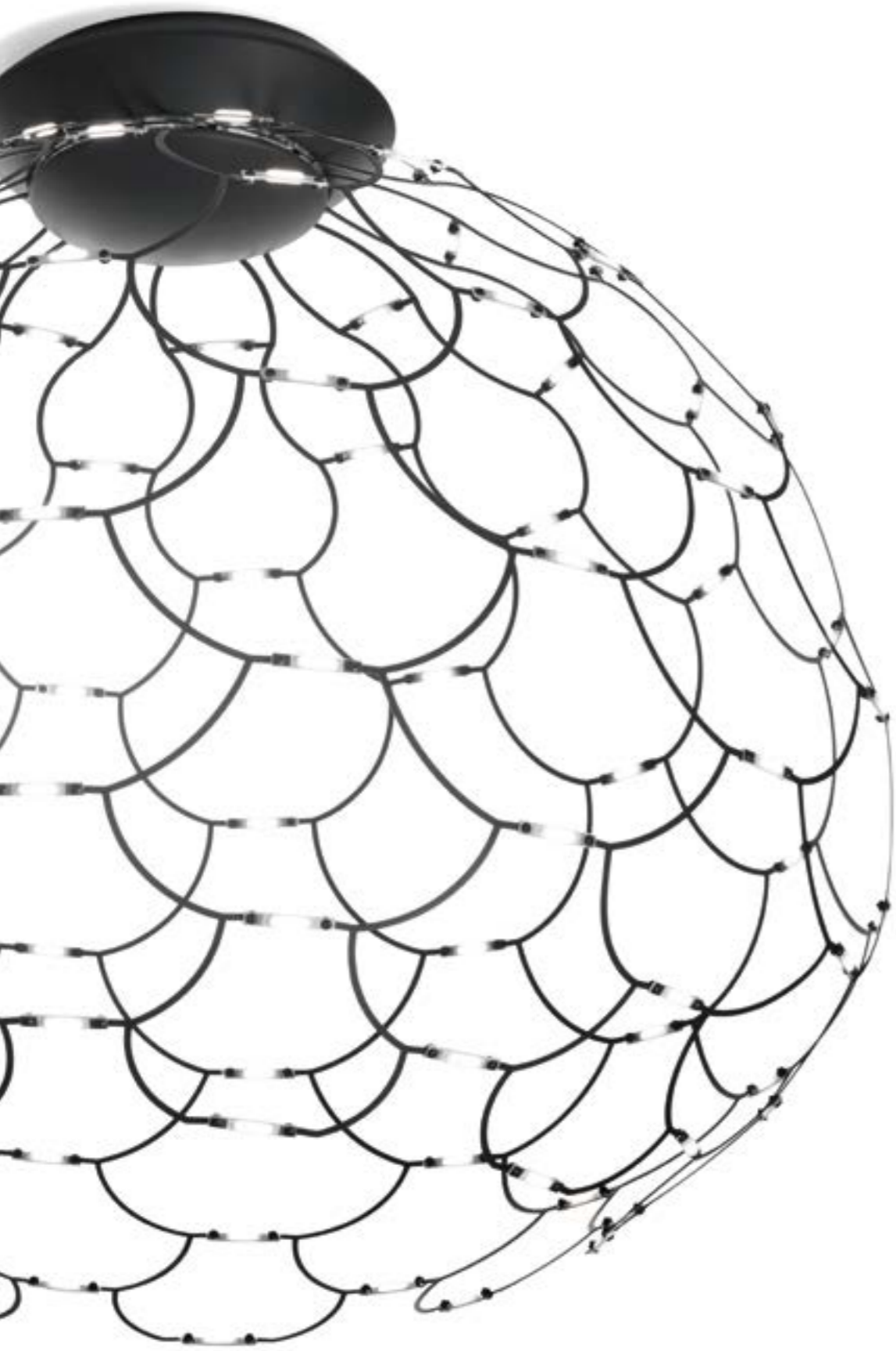

LAMOI 2.0 CEILING



LAMOI 2.0 CEILING



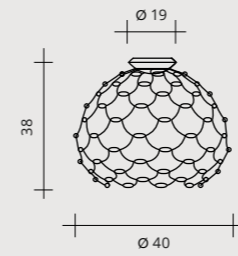

LED 49W - 24V
2700°K / 5468 lumen
3000°K / 6076 lumen

Versions:

On-Off

Push
Dali
0-10v
1-10v

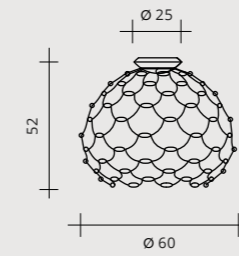

LED 72W - 24V
2700°K / 8035 lumen
3000°K / 8928 lumen

Versions:

On-Off

Push
Dali
0-10v
1-10v

Triac

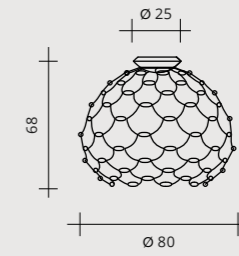

LED 99W - 24V
2700°K / 9939 lumen
3000°K / 11044 lumen

Versions:

On-Off

Push
Dali
0-10v
1-10v

LAMOI Ceiling

Lampada da soffitto
Deckenleuchte
Lámpara de techo
Потолочная лампа



FINISHES / FINITURE / FARBE / ACABADOS / ОТДЕЛКИ

- Copper / Rame / Kupfe / Cobre / Медь
- Chrome / Cromo / Chrom / Cromo / Хром
- Gold / Oro / Kupfe / Gold / Золото

LAMOI 2.0 Ceiling

Lampada da soffitto
Deckenleuchte
Lámpara de techo
Потолочная лампа



FINISHES / FINITURE / FARBE / ACABADOS / ОТДЕЛКИ

- Matt black / Nero opaco / Mattschwarz / Negro mate / Матовый черный

LAMOI Suspension

Lampada a sospensione
Pendelleuchte
Lámpara colgante
Подвесная лампа



FINISHES / FINITURE / FARBE / ACABADOS / ОТДЕЛКИ

- Copper / Rame / Kupfe / Cobre / Медь
- Chrome / Cromo / Chrom / Cromo / Хром
- Gold / Oro / Kupfe / Gold / Золото

LAMOI 2.0 Suspension

Lampada a sospensione
Pendelleuchte
Lámpara colgante
Подвесная лампа



FINISHES / FINITURE / FARBE / ACABADOS / ОТДЕЛКИ

- Matt black / Nero opaco / Mattschwarz / Negro mate / Матовый черный

See codes and prices from page to page / Vedi codici e prezzi da pag a pag. / Artikelnummern und Preise siehe Seite bis Seite
Véanse códigos y precios desde pág. hasta pág. / См. коды и цены от страницы до страницы

348 - 349 - 351

LAMOI FLOOR



LAMOI

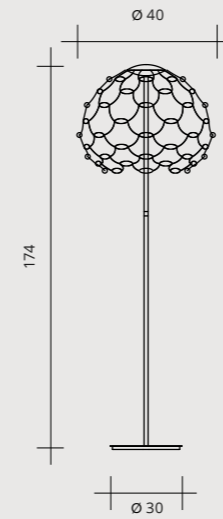

LED 49W - 24V
2700°K / 5468 lumen
3000°K / 6076 lumen

LAMOI

Floor

Floor lamp. Footswitch dimmer included.

Lampada da terra, dimmer a pedale incluso.

Stehleuchte. Inklusive Fußschalter und Dimmer.

Lámpara de pie. Regulador de intensidad con pedal incluido.

Напольный светильник. В комплект входит диммер с ножным управлением.



FINISHES / FINITURE / FARBE / ACABADOS / ОТДЕЛКИ

- Copper / Rame / Kupfe / Cobre / Медь
- Chrome / Cromo / Chrom / Cromo / Хром
- Gold / Oro / Kupfe / Gold / Золото

TESA

Marco Spatti

TESA

A shining microcosm.
Star-like points of light,
suspended in a harmonious
and balanced geometric orbit.
Both the large Tesa version and the
mini version convey a sense of lightness,
appeal, intimacy and personality.
LED and metal structure in a single
body enhance an elegant lamp of solids
and voids, sparkles and reflections,
with a strong visual impact.
Available in the 2700°k
and 3000°k version.
Dimmable and non-dimmable.



TESA

Un microcosmo splendente.
Punti di luce, quasi stelle,
sospesi in un'orbita geometrica
armonica ed equilibrata.
Sia la versione grande Tesa che
Tesa mini, esprimono leggerezza,
appeal, intimità e personalità.
Led e struttura metallica in corpo
unico esaltano una lampada
elegante, di pieni e di vuoti, scintillii
e riflessi, dal forte impatto visivo.
Disponibile 2700°k e 3000°k.
Dimmerabile e non.

TESA

Ein leuchtender Mikrokosmos.
Lichtpunkte, fast Sterne,
die in einer harmonischen und
ausgewogenen geometrischen
Umlaufbahn schweben.
Sowohl die große Tesa-Version
als auch die Tesa Mini, drücken
Leichtigkeit Attraktivität, Intimität
und Persönlichkeit aus. Die LED und
die Metallstruktur in einem einzigen
Gehäuse ergeben eine elegante
Leuchte mit einer Mischung aus
Voll- und Hohlräumen, Glitzern und
Reflexen, die eine starke visuelle
Wirkung hat. Erhältlich in 2700°k
und 3000°k. Dimmbar und nicht
dimmbar.

TESA

Un microcosmos brillante.
Puntos de luz, casi estrellas,
suspensos en una órbita
geométrica armoniosa y equilibrada.
Tanto la versión grande de Tesa
como Tesa mini, expresan ligereza,
atractivo, intimidad y personalidad.
LED y estructura metálica en un solo
cuerpo realzan una elegante lámpara
de sólidos y vacíos, destellos y reflejos,
con un fuerte impacto visual.
Disponibile en 2700°k y 3000°k.
Regulable y no regulable.

TESA

Сияющий микрокосмос.
Светящиеся точки, почти звезды,
«подвешенные» на гармонично
сбалансированной геометрической
орбите. И Tesa в большой версии,
и Tesa мини-формата являются
олицетворением легкости,
притягательной силы, уюта
и оригинальности. Светодиоды
и металлическая конструкция
превращаются в цельный корпус,
образуя необычайно эффектный и
элегантный светильник, сотканный
из полных и пустых объемов, искр
и отражений. Доступны варианты
2700°k и 3000°k. Версии с диммером
и без него.









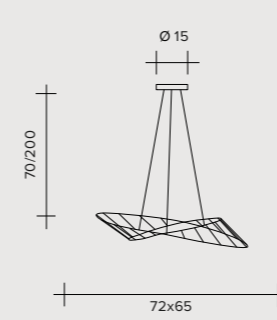

LED 20W - 24V
2700°K / 2232 lumen
3000°K / 2480 lumen

Versions:

On-Off

Push
Dali
0-10v
1-10v

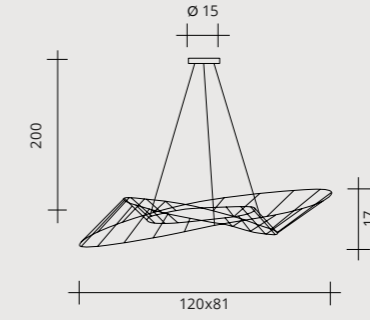

LED 40W - 24V
2700°K / 4464 lumen
3000°K / 4960 lumen

Versions:

On-Off

Push
Dali
0-10v
1-10v

TESA Suspension

Lampada a sospensione
Pendelleuchte
Lámpara colgante
Подвесная лампа



FINISHES / FINITURE / FARBE / ACABADOS / ОТДЕЛКИ

- Matt powder pink / Cipria opaco / Puderfarben matt
Rosa palo mate / Пудровый матовый
- Matt copper / Rame opaco / Kupferfarben matt
Cobre mate / Медный матовый

TESA CEILING

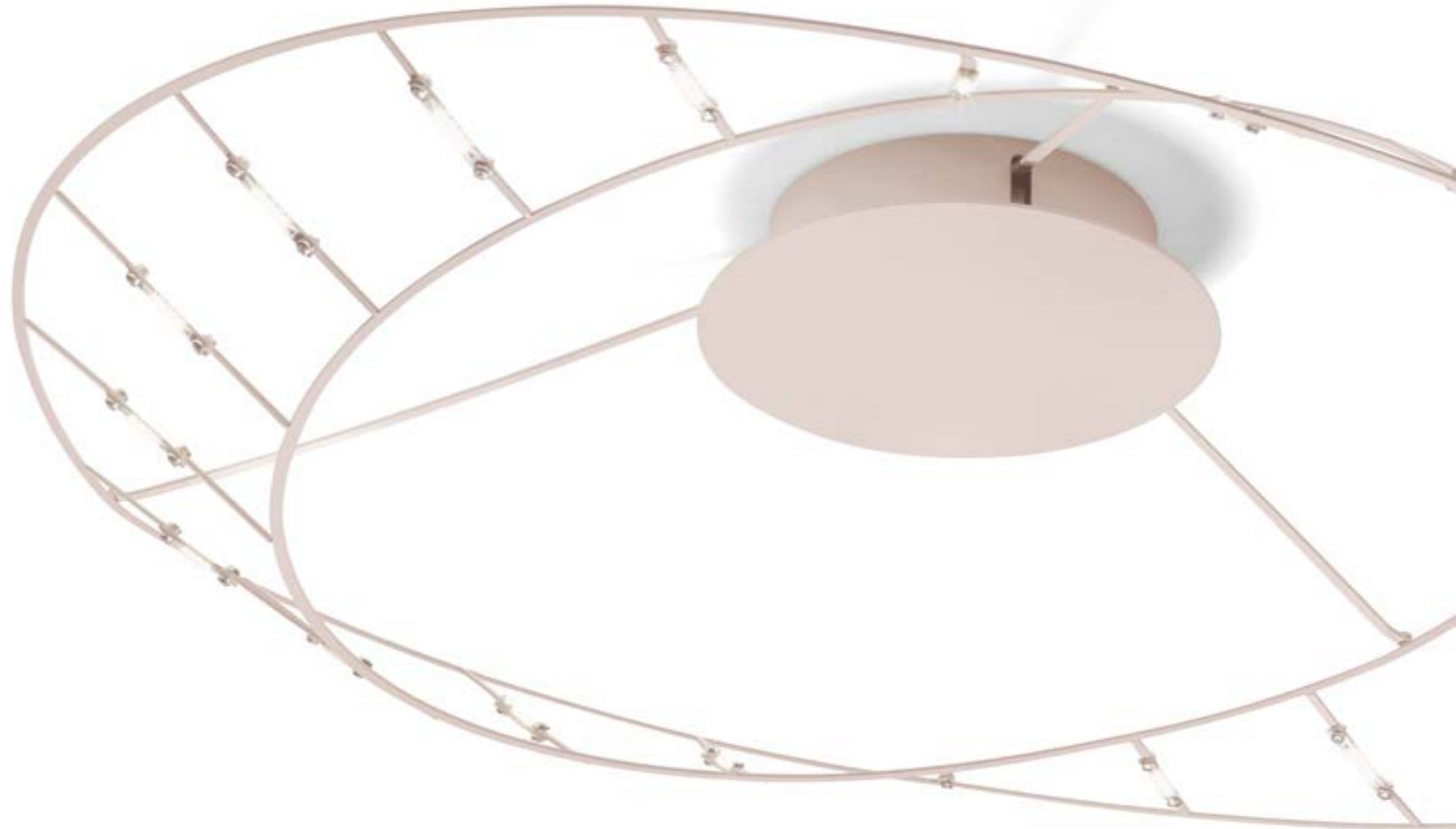



TESA CEILING

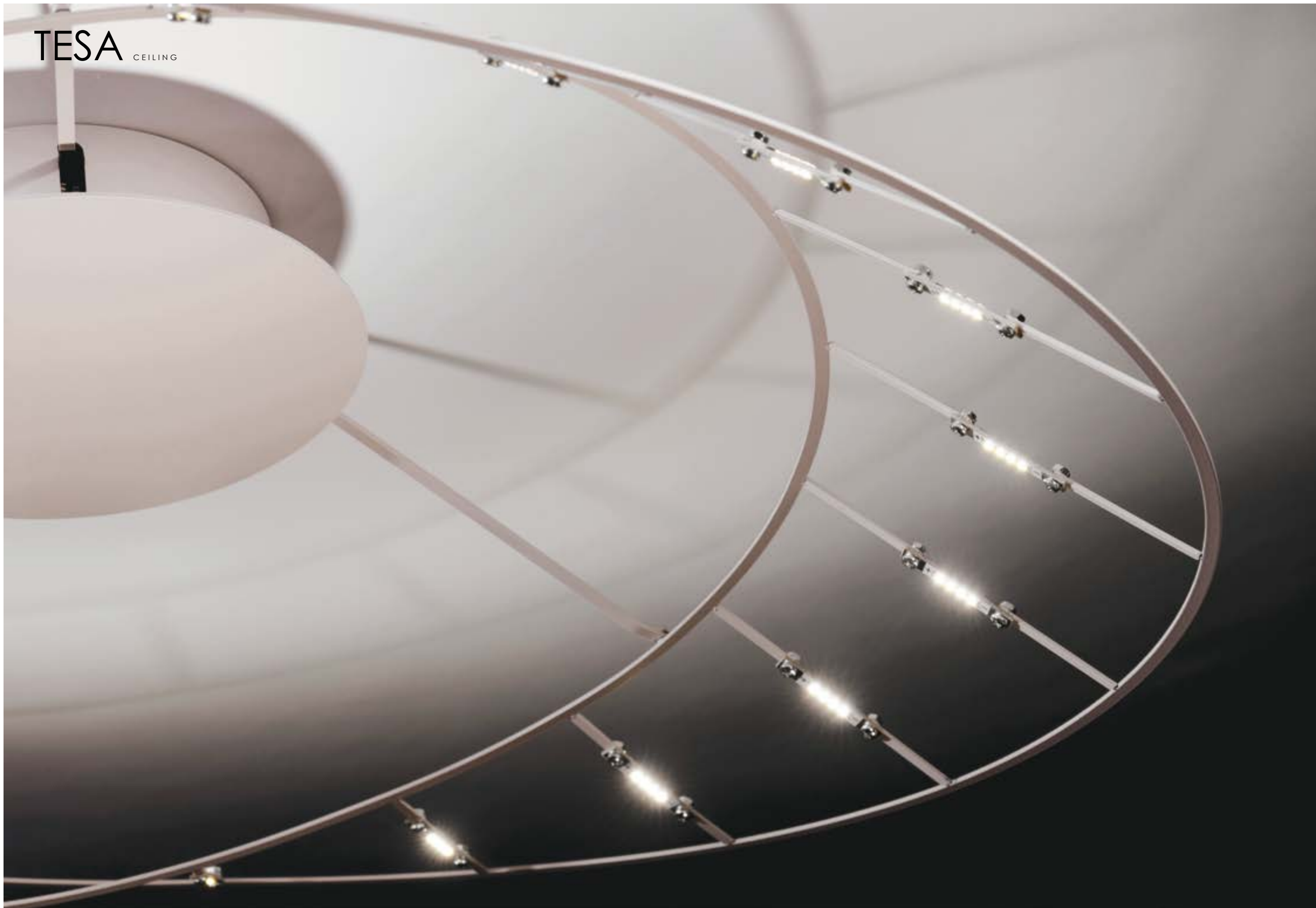

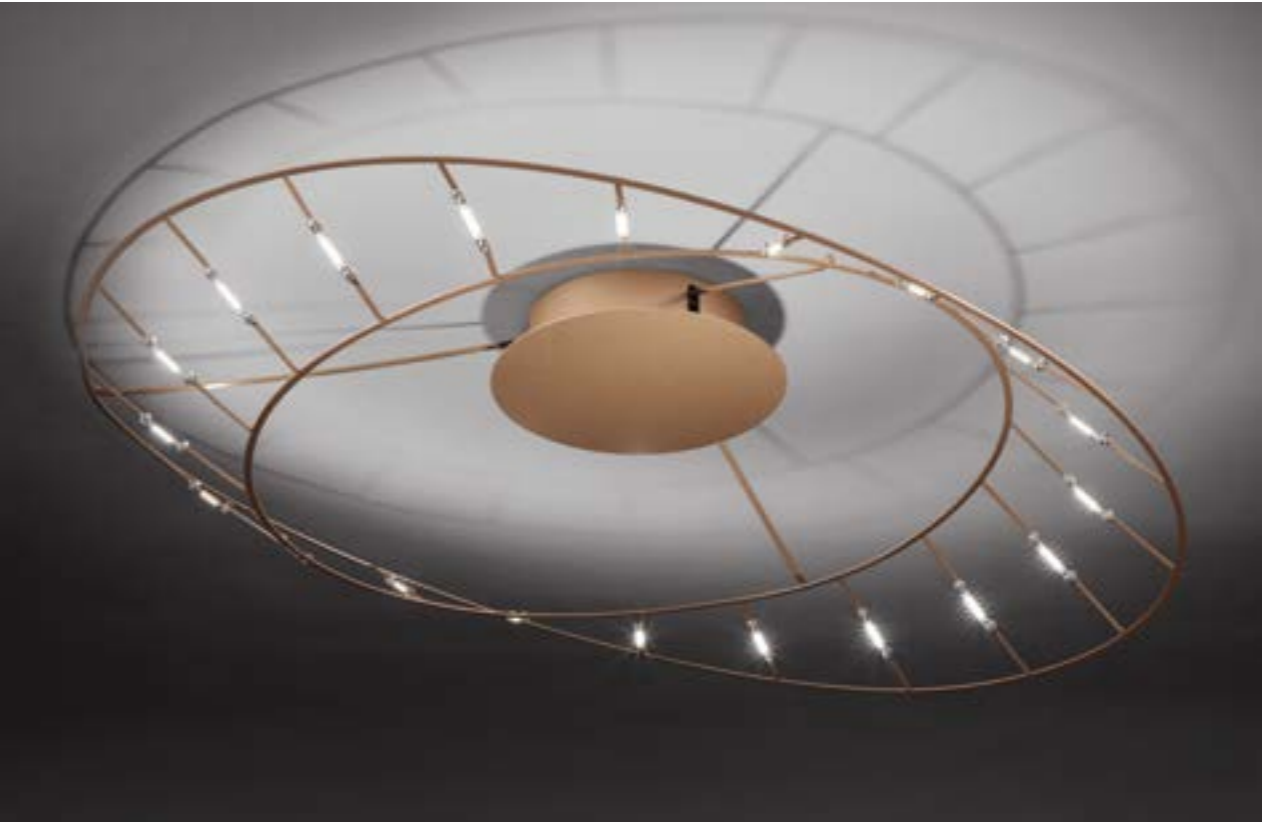
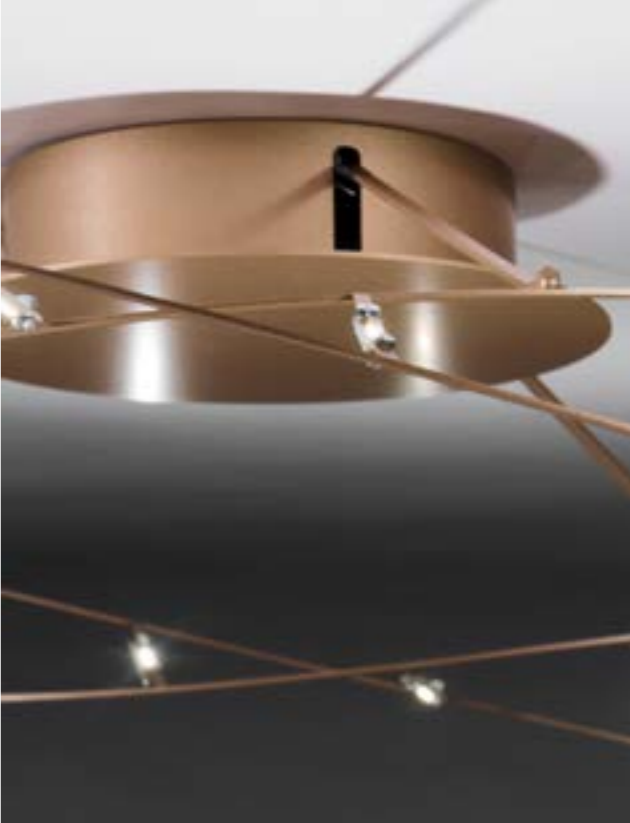



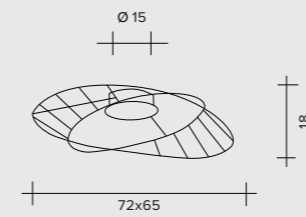
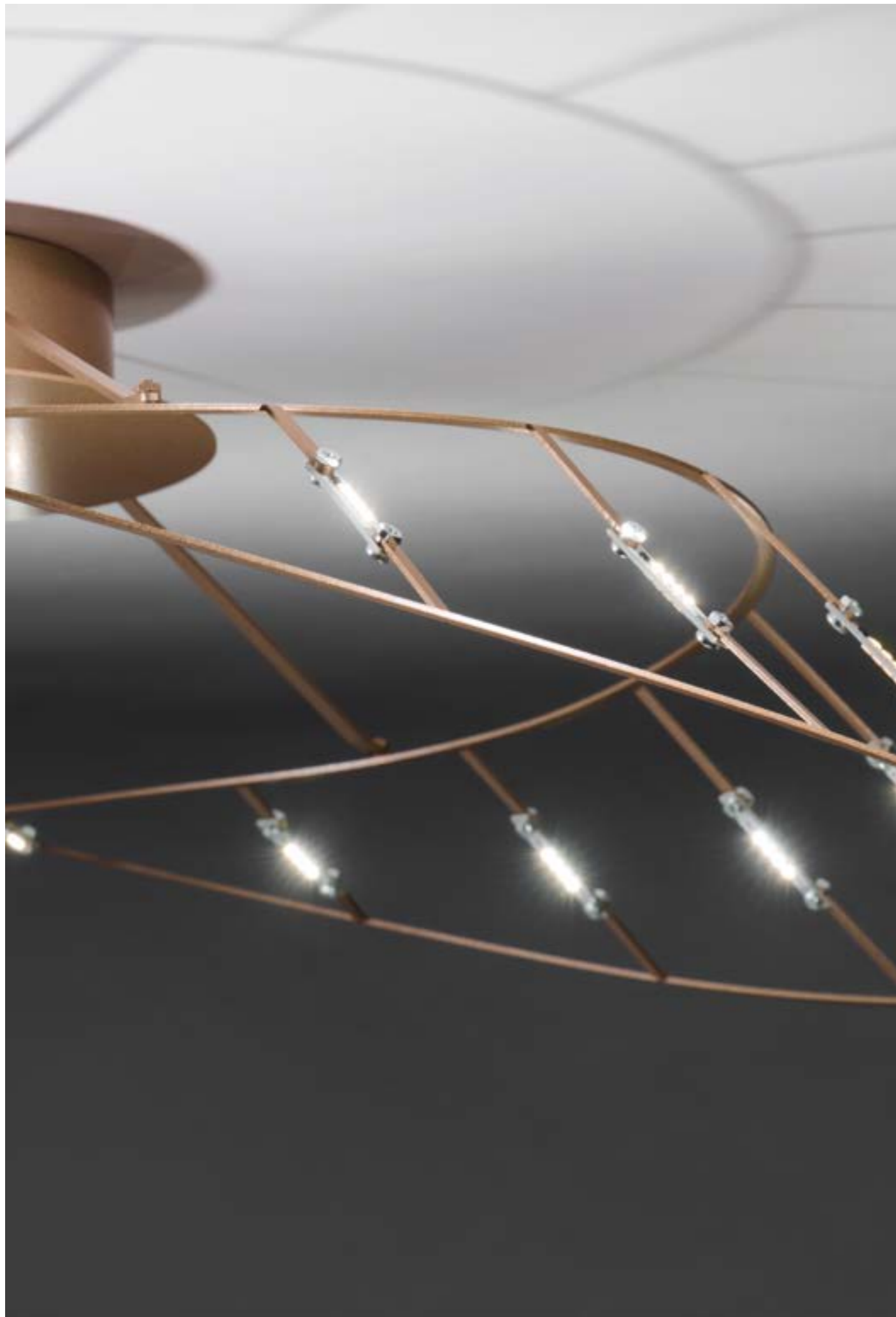

LED 20W - 24V
2700°K / 2232 lumen
3000°K / 2480 lumen

Versions:

On-Off

Push
Dali
0-10v
1-10v

TESA Ceiling

Lampada da soffitto
Deckenleuchte
Lámpara de techo
Потолочная лампа



FINISHES / FINITURE / FARBE / ACABADOS / ОТДЕЛКИ

- Matt powder pink / Cipria opaco / Puderfarben matt
Rosa palo mate / Пудровый матовый
- Matt copper / Rame opaco / Kupferfarben matt
Cobre mate / Медный матовый



TESA 2.0 SUSPENSION

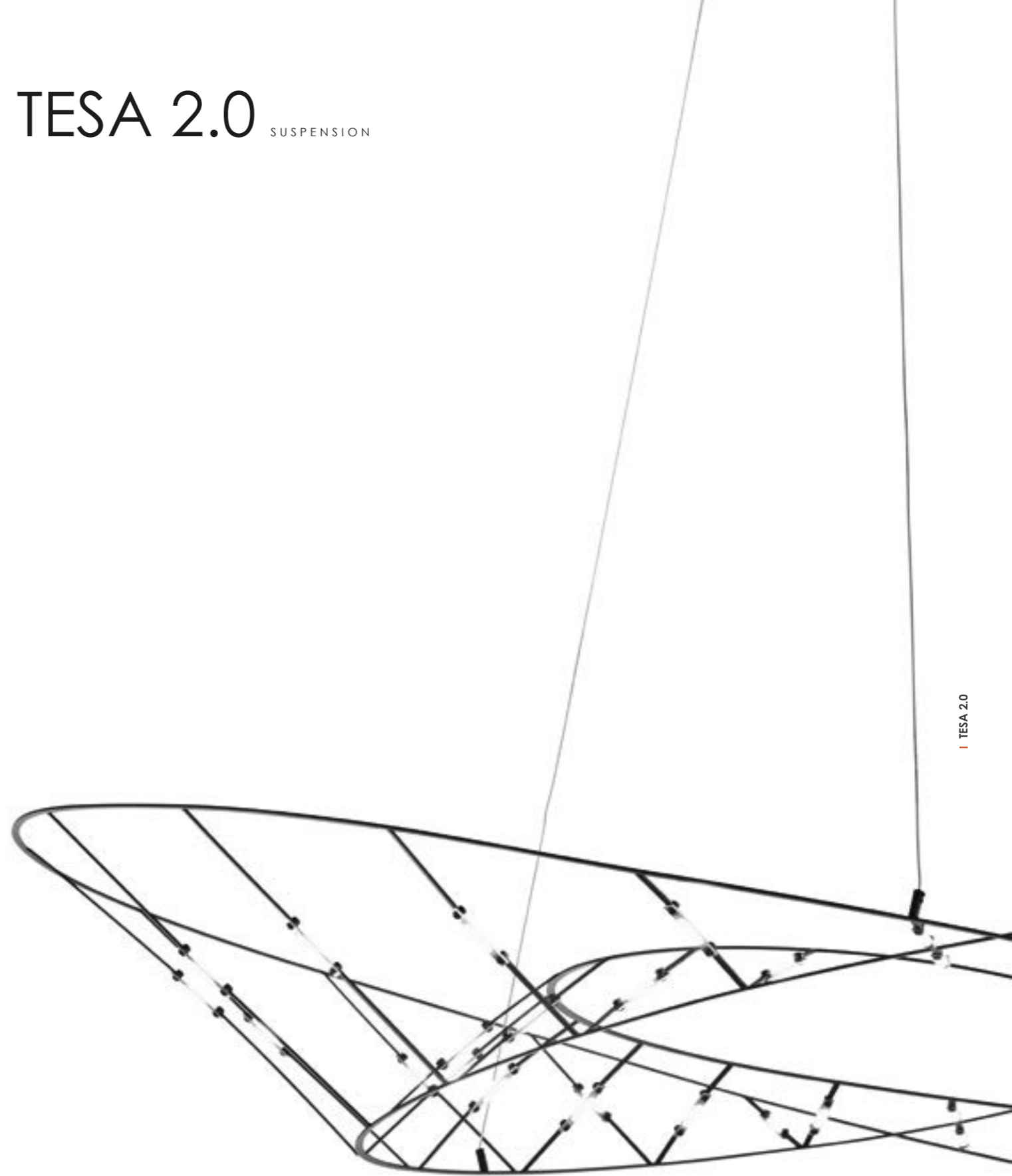

TESA 2.0 SUSPENSION

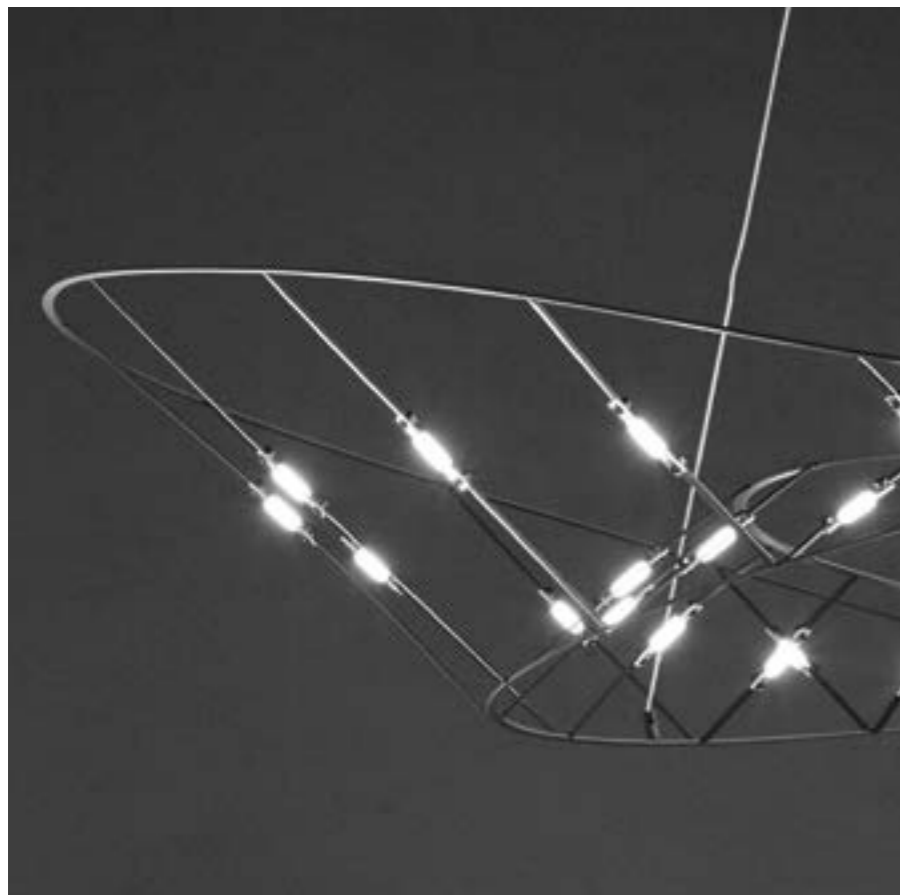

TESA 2.0 SUSPENSION



TESA 2.0 SUSPENSION



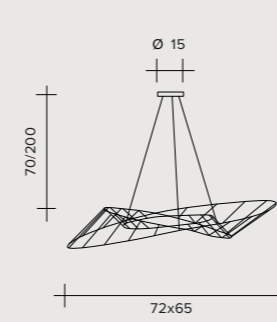

LED 20W - 24V
2700°K / 2232 lumen
3000°K / 2480 lumen

Versions:

On-Off

Push
Dali
0-10v
1-10v

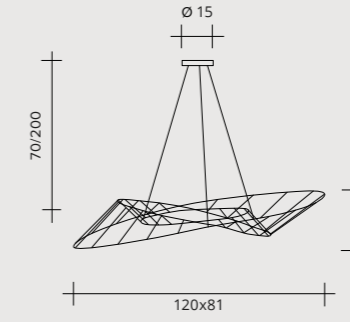

LED 40W - 24V
2700°K / 4464 lumen
3000°K / 4960 lumen

Versions:

On-Off

Push
Dali
0-10v
1-10v

TESA 2.0 Suspension

Lampada a sospensione
Pendelleuchte
Lámpara colgante
Подвесная лампа



FINISHES / FINITURE / FARBE / ACABADOS / ОТДЕЛКИ

● Matt black / Nero opaco / Mattschwarz / Negro mate / Матовый черный/ве

TESA 2.0 CEILING

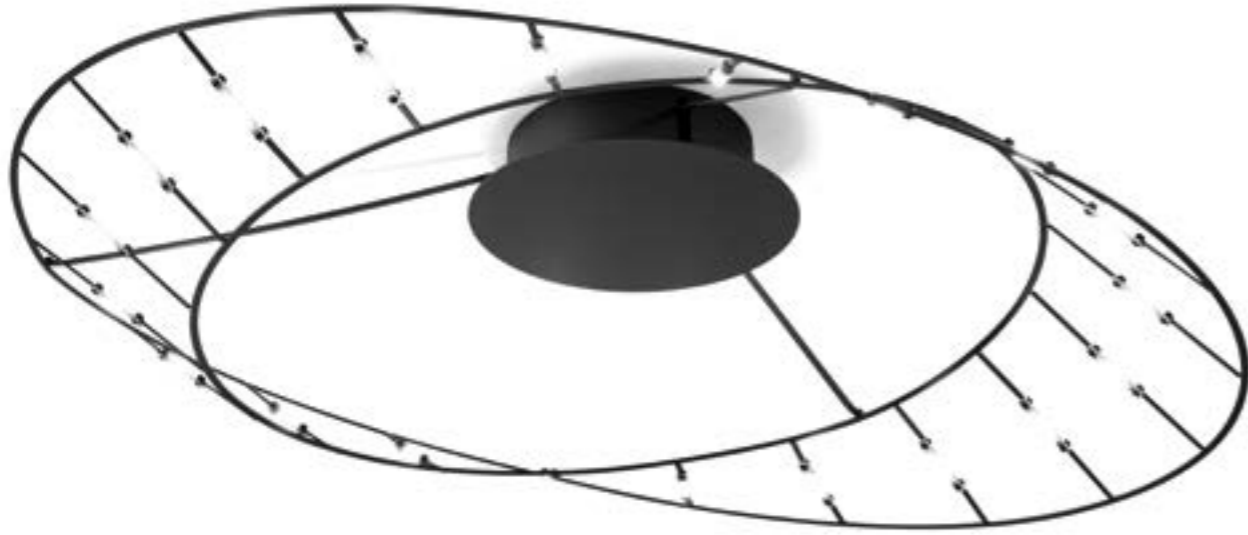

TESA 2.0 CEILING



TESA 2.0 CEILING

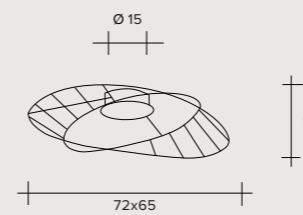
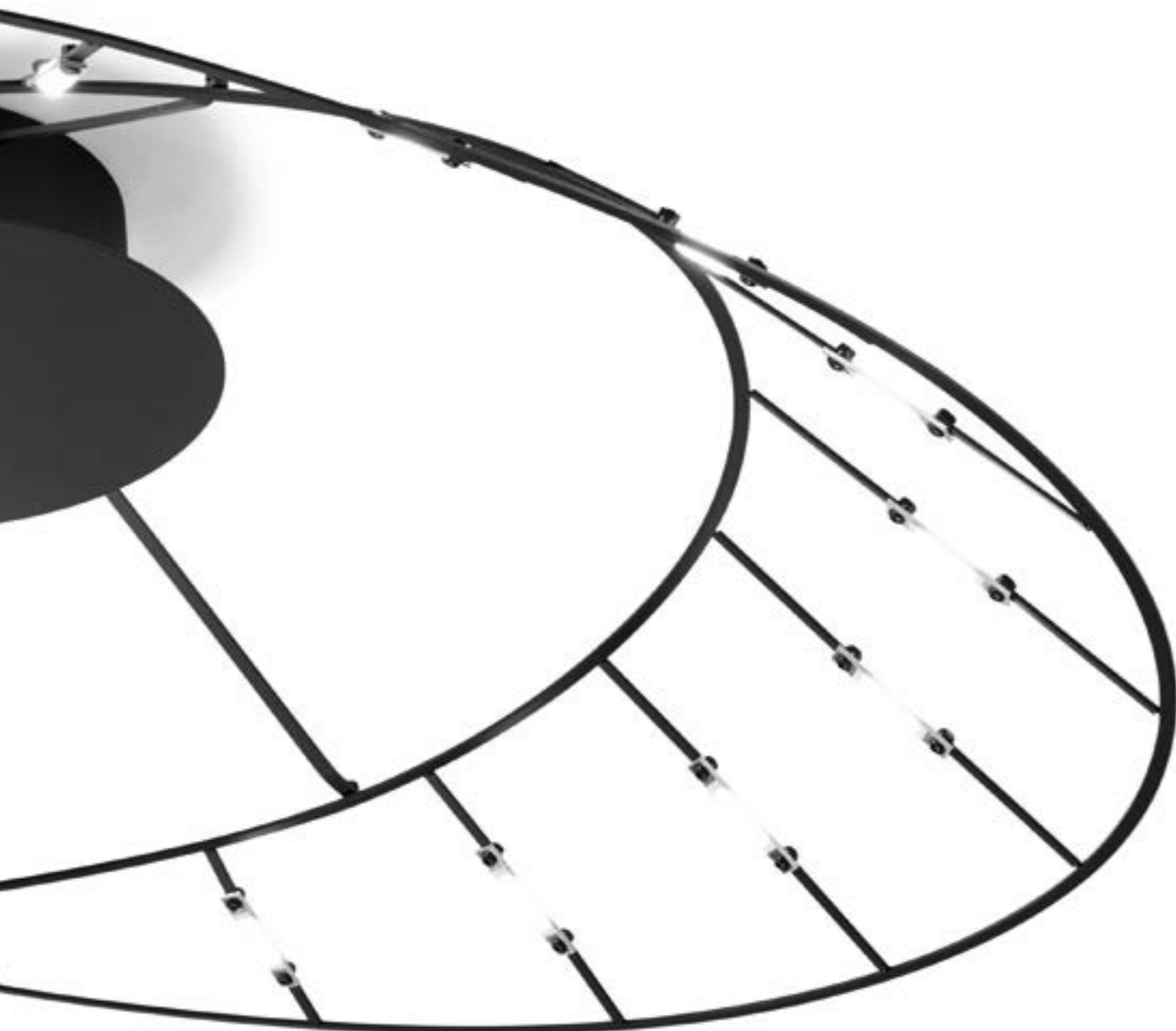

LED 20W - 24V
2700°K / 2232 lumen
3000°K / 2480 lumen

Versions:

On-Off

Push
Dali
0-10v
1-10v

TESA 2.0 Ceiling

Lampada da soffitto
Deckenleuchte
Lámpara de techo
Потолочная лампа



FINISHES / FINITURE / FARBE / ACABADOS / ОТДЕЛКИ

- Matt black / Nero opaco / Mattschwarz / Negro mate / Матовый черный/в

LAFRA

Andrea Barra

LAFRA

Pure elegance and stylistic innovation.
A family of products
that satisfy the desire for light,
technology and aesthetics.
The current-conducting metal powers
and switches on the 1w LED modules.
Available in the 2700°k and 3000°k version.
Dimmable and non-dimmable,
with covers available as optional accessories.

LAFRA

*Eleganza pura
e innovazione stilistica.
Una famiglia di prodotti
che soddisfano il desiderio di
luce, di tecnologia e di estetica.
Il metallo, conduttore di corrente
alimenta e accende
i moduli led da 1 w.
Disponibile 2700°K e 3000°K.
Dimmerabile e non,
le coperture sono optional.*

LAFRA

*Pure Eleganz und
stilistische Innovation.
Eine Familie von Produkten die
das Verlangen nach Licht, Technik
und Ästhetik befriedigen. Das
stromführende Metall versorgt die
Schalter an den 1-W-LED-Modulen
mit Strom und schaltet sie ein.
Erhältlich in 2700°k und 3000°k.
Dimmbar und nicht dimmbar,
Abdeckungen sind fakultativ.*

LAFRA

*Pura elegancia
e innovación estilística.
Una familia de productos
que satisfacen el deseo de luz,
de tecnología y de estética.
El metal, conductor de corriente,
alimenta y enciende los
módulos LED de 1 w.
Disponibile en 2700°K y 3000°K.
Regulable y no regulable, las
cubiertas son opcionales.*

LAFRA

*Чистая элегантность и
стилистические инновации.
Серия изделий, отражающих
стремление к свету,
технологичности и эстетике.
Токопроводящий металл подает
питание на светодиодные модули
мощностью 1 Вт.
Доступны варианты 2700°K
и 3000°K. Версии с диммером
и без него, крышки являются
опциональными элементами.*



LAFRA CEILING

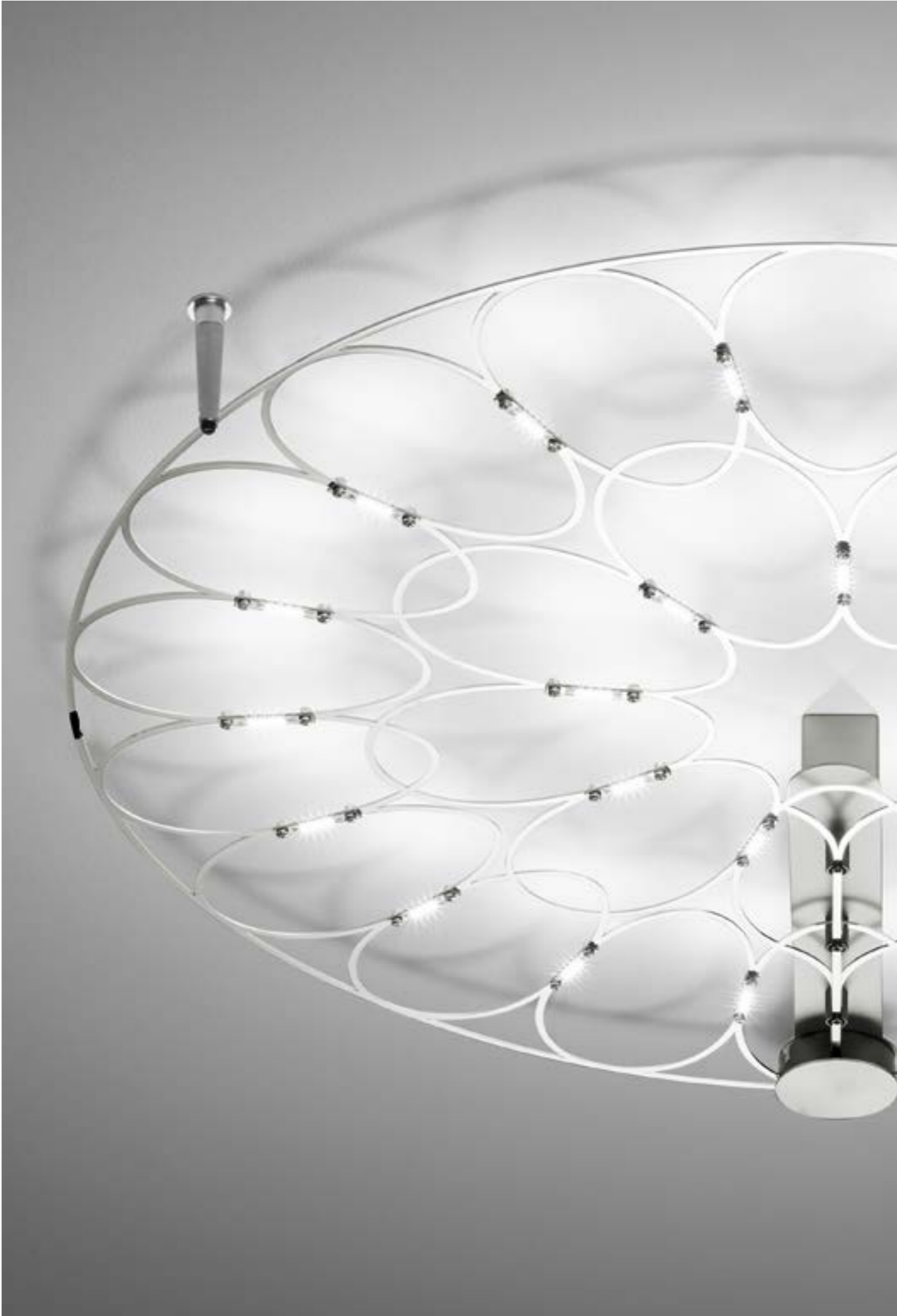

LAFRA



LAFRA

CEILING





LAFRA 2.0 CEILING

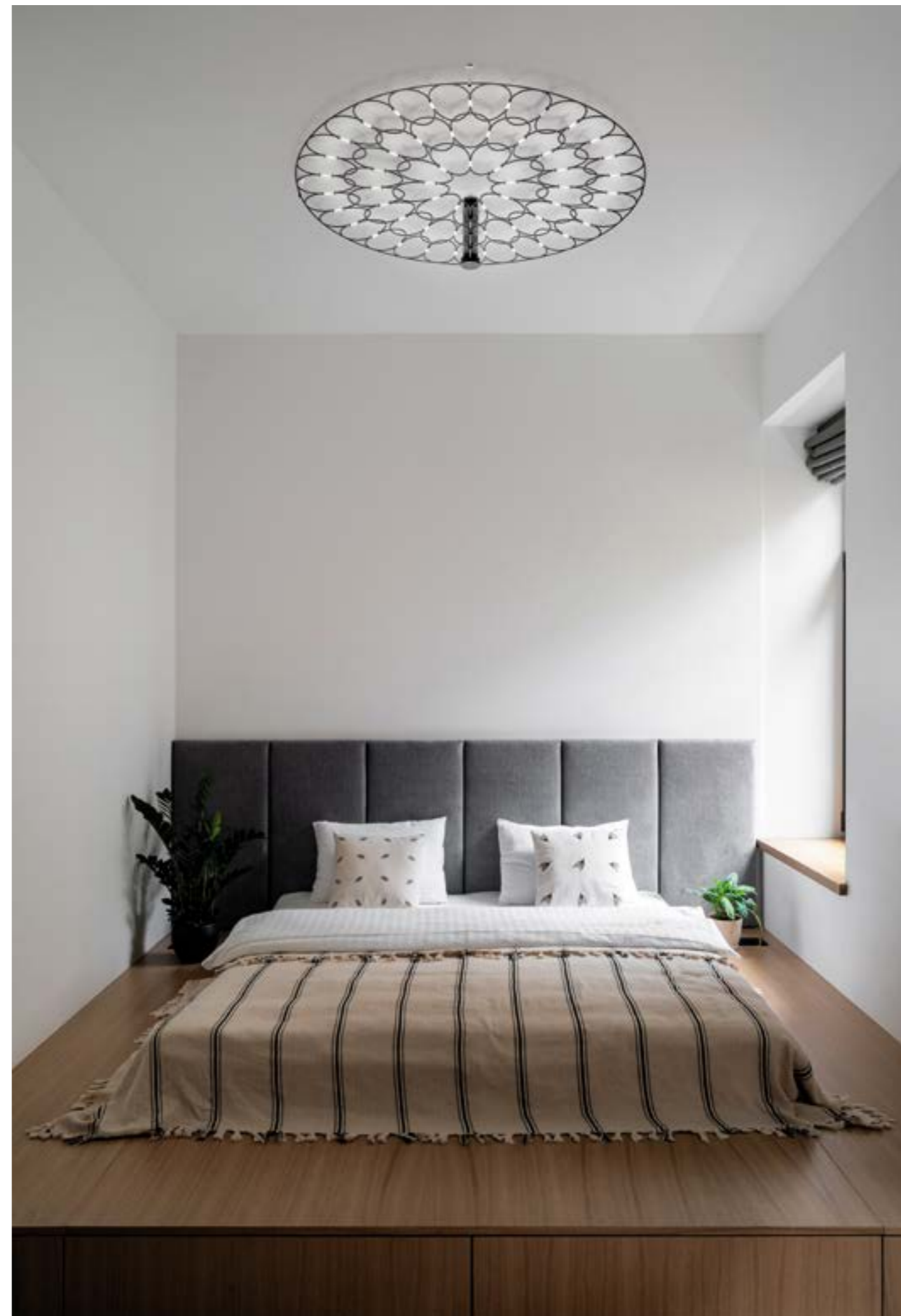
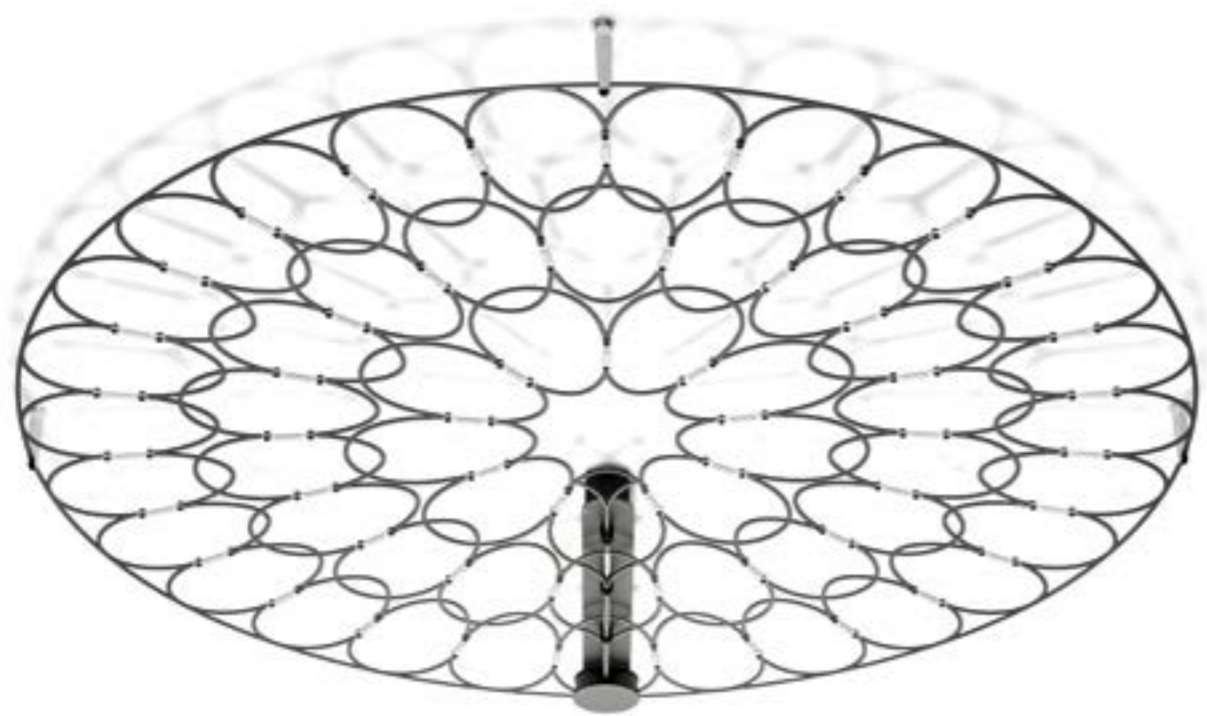

LAFRA 2.0 CEILING

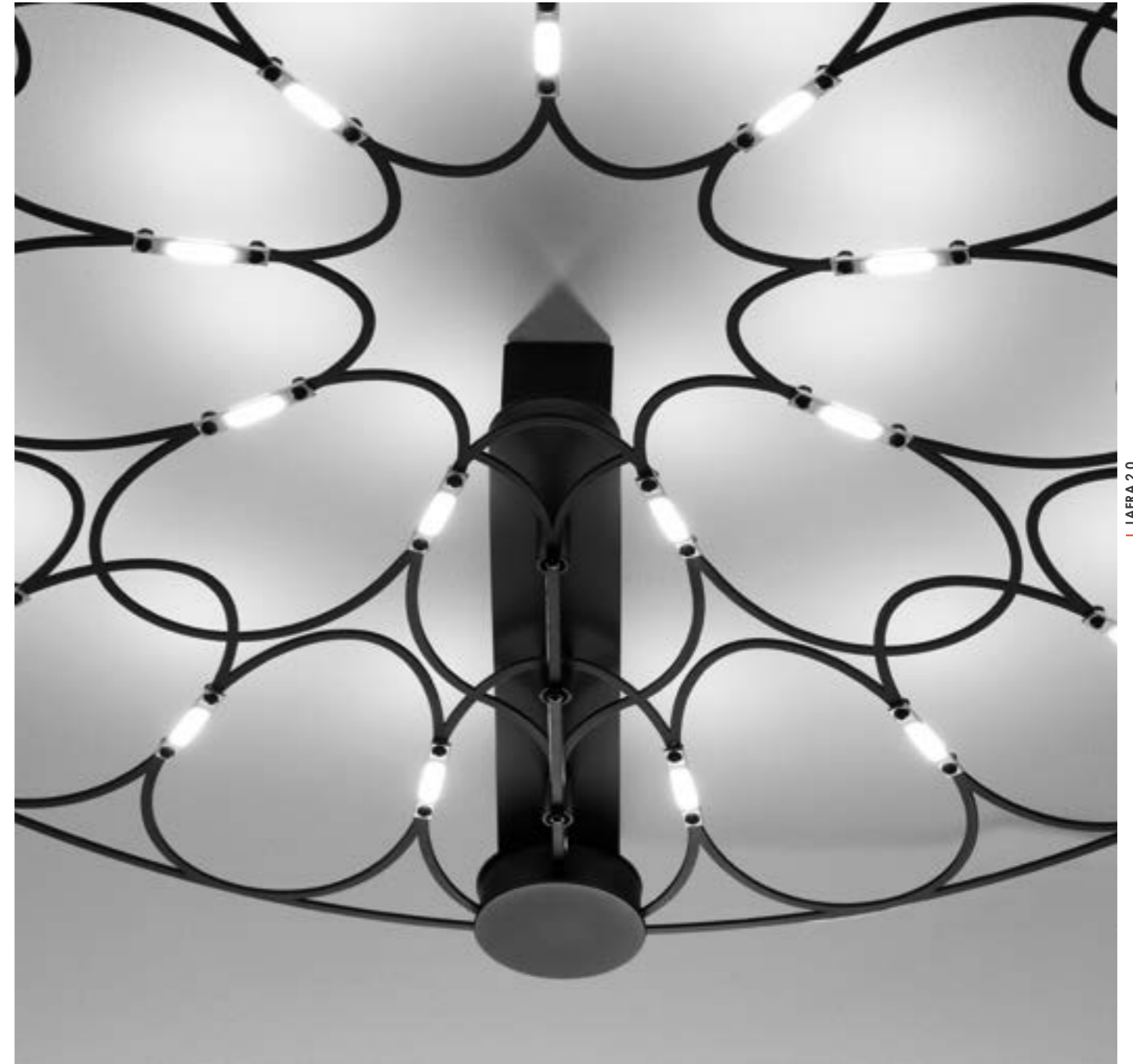

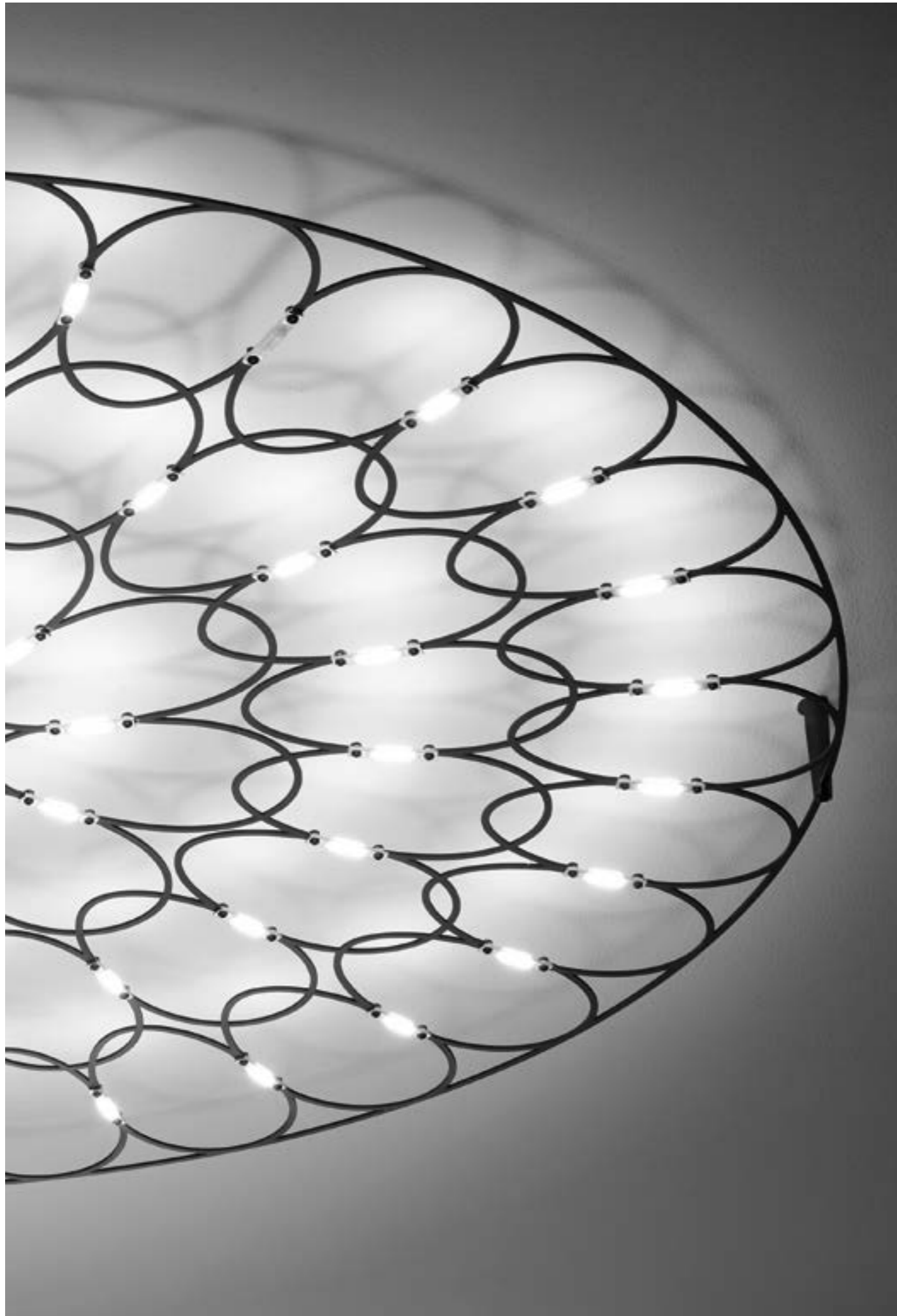

LED 9W - 24V
2700°K / 735 lumen
3000°K / 817 lumen

Version:

On-Off

Push

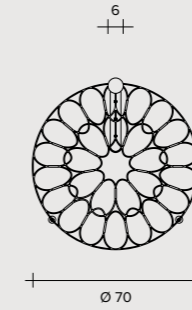

LED 27W - 24V
2700°K / 2150 lumen
3000°K / 2389 lumen

Version:

On-Off

Push

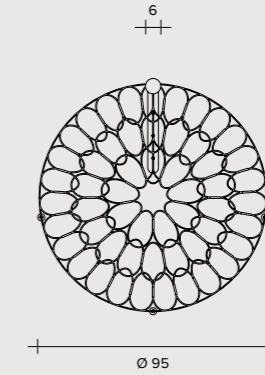

LED 54W - 24V
2700°K / 4300 lumen
3000°K / 4778 lumen

Version:

On-Off

Push

LAFRA Ceiling

Lampada da soffitto
Deckenleuchte
Lámpara de techo
Потолочная лампа



FINISHES / FINITURE / FARBE / ACABADOS / ОТДЕЛКИ

● Chrome / Cromo / Chrom / Cromo / Хром

LAFRA 2.0 Ceiling

Lampada da soffitto
Deckenleuchte
Lámpara de techo
Потолочная лампа



FINISHES / FINITURE / FARBE / ACABADOS / ОТДЕЛКИ

● Black / Nero / Schwarz / Negro / Чёрный цвет

LAFRA WALL





LAFRA WALL



LAFRA 2.0 WALL



LAFRA 2.0 WALL

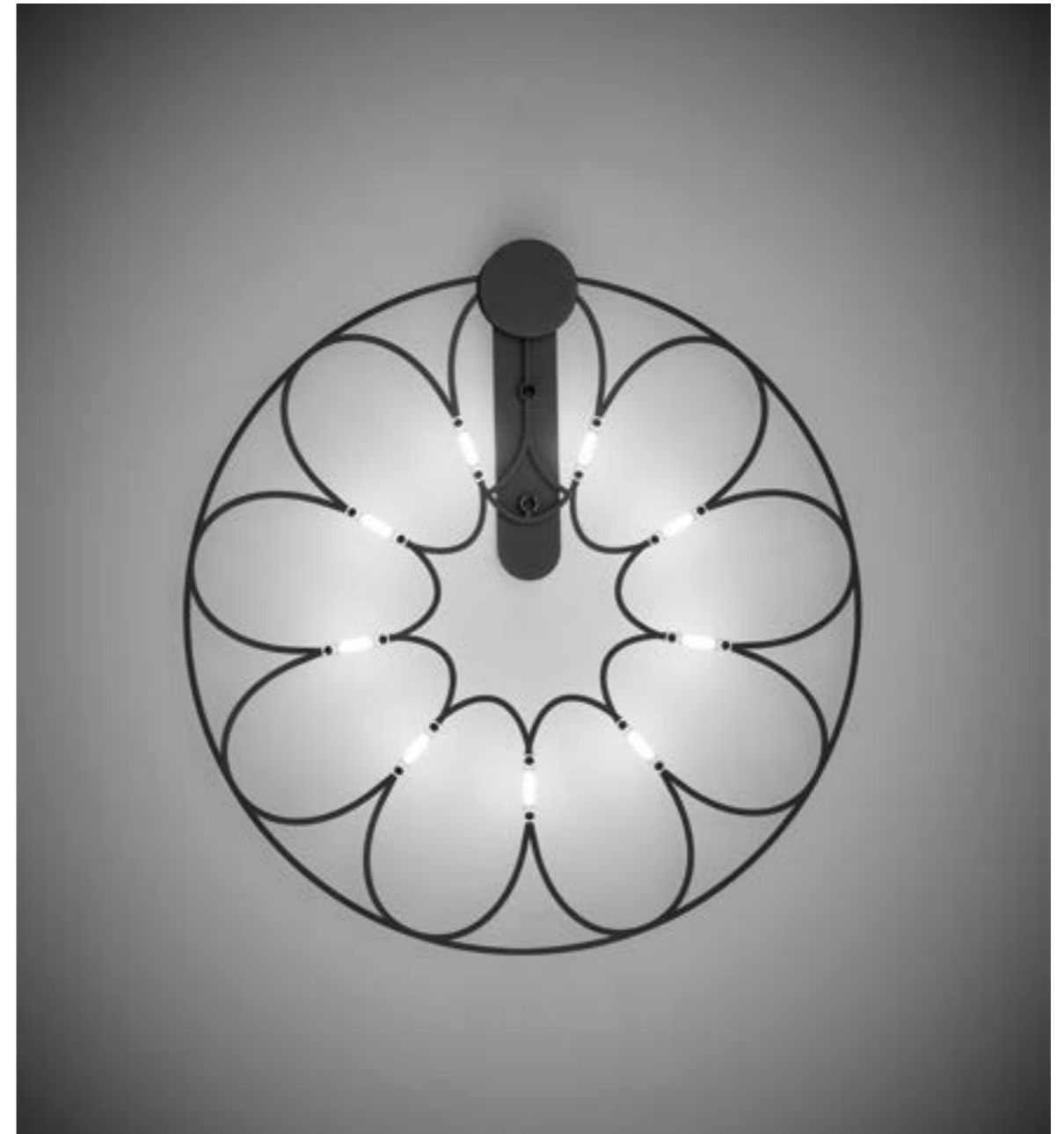
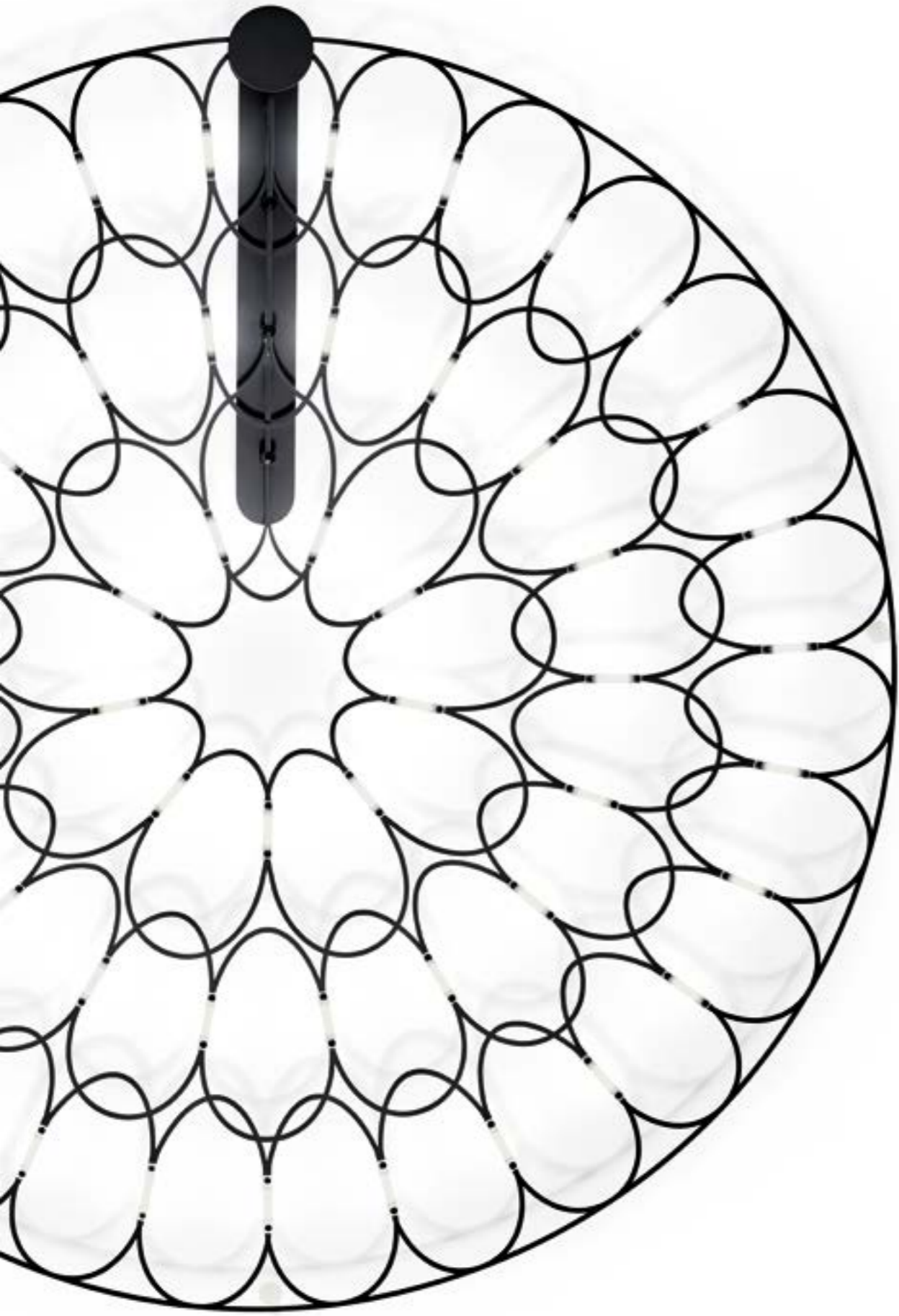



LED 9W - 24V
2700°K / 735 lumen
3000°K / 817 lumen

Version:

On-Off

Push

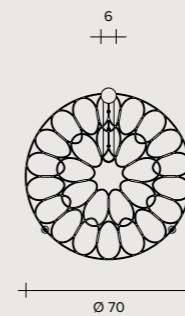

LED 27W - 24V
2700°K / 2150 lumen
3000°K / 2389 lumen

Version:

On-Off

Push

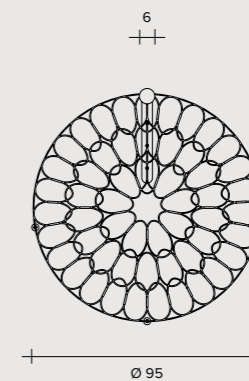

LED 54W - 24V
2700°K / 4300 lumen
3000°K / 4778 lumen

Version:

On-Off

Push

LAFRA Wall

Lampada da parete
Wandleuchte
Lámpara de pared
Настенная лампа



FINISHES / FINITURE / FARBE / ACABADOS / ОТДЕЛКИ

● Chrome / Cromo / Chrom / Cromo / Хром

LAFRA 2.0 Wall

Lampada da parete
Wandleuchte
Lámpara de pared
Настенная лампа



FINISHES / FINITURE / FARBE / ACABADOS / ОТДЕЛКИ

● Black / Nero / Schwarz / Negro / Чёрный цвет

BEBA

Urban Design Team

BEBA

An-almost alchemical vision, the series of pendant lamps with soft shapes represents a light borosilicate glass blow, which is pure poetry of light. Available with white off-centre kit or single drop-down ceiling canopy, in the same white colour. G9 connection.

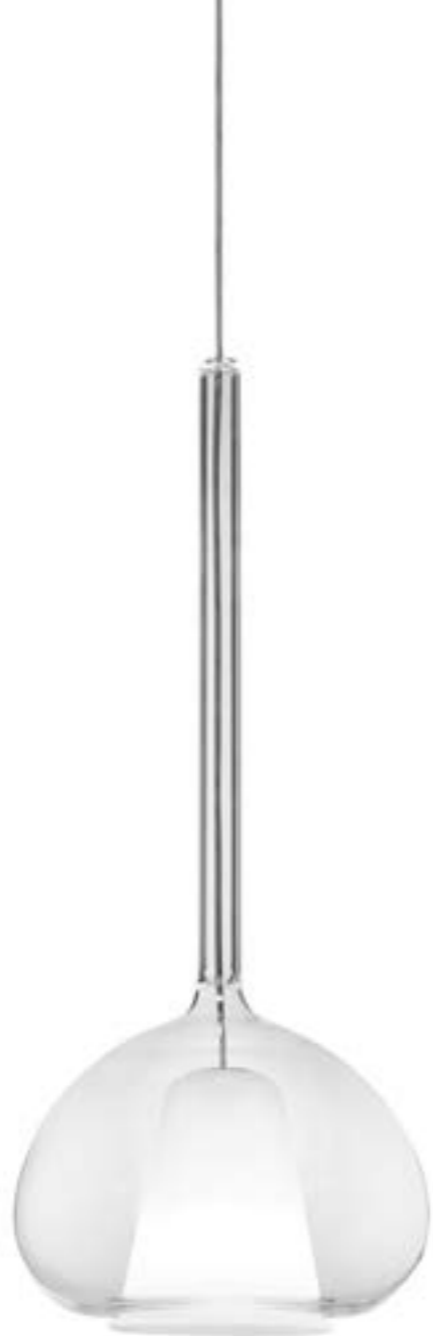

BEBA

Quasi una visione alchemica, la serie di sospensioni dalle forme morbide rappresenta un soffio leggero in vetro borosilicato che è pura poesia della luce. Disponibile con kit di decentramento bianco o rosoni da calata unica, sempre bianchi. L'attacco è G9.

BEBA

Fast wie eine alchemistische Vision stellt die sanft geformte Hängeserie einen leichten Atem in Borosilikatglas dar, der reine Poesie des Lichts ist. Erhältlich mit weißem, außermittig angeordnetem Bausatz oder mit einzelnen abklappbaren Rosetten, immer weiß. Die Verbindung ist G9.

BEBA

Casi una visión alquímica, la serie de suspensión de formas delicadas representa un soplo ligero en vidrio de borosilicato que es pura poesía de luz. Disponible con kit de descentrado blanco o rosetas desplegables sencillas, siempre en blanco. La conexión es G9.

BEBA

Серия подвесных светильников с мягкими формами, точно вышедших из алхимической лаборатории. Выполненные из легкого дутого боросиликатного стекла светильники олицетворяют собой незамутненную поэзию света. Могут поставляться с белым комплектом для смещенного крепления или с потолочными чашками с одним выводом, также белого цвета. Цоколь G9.



BEBA SUSPENSION



BEBA SUSPENSION

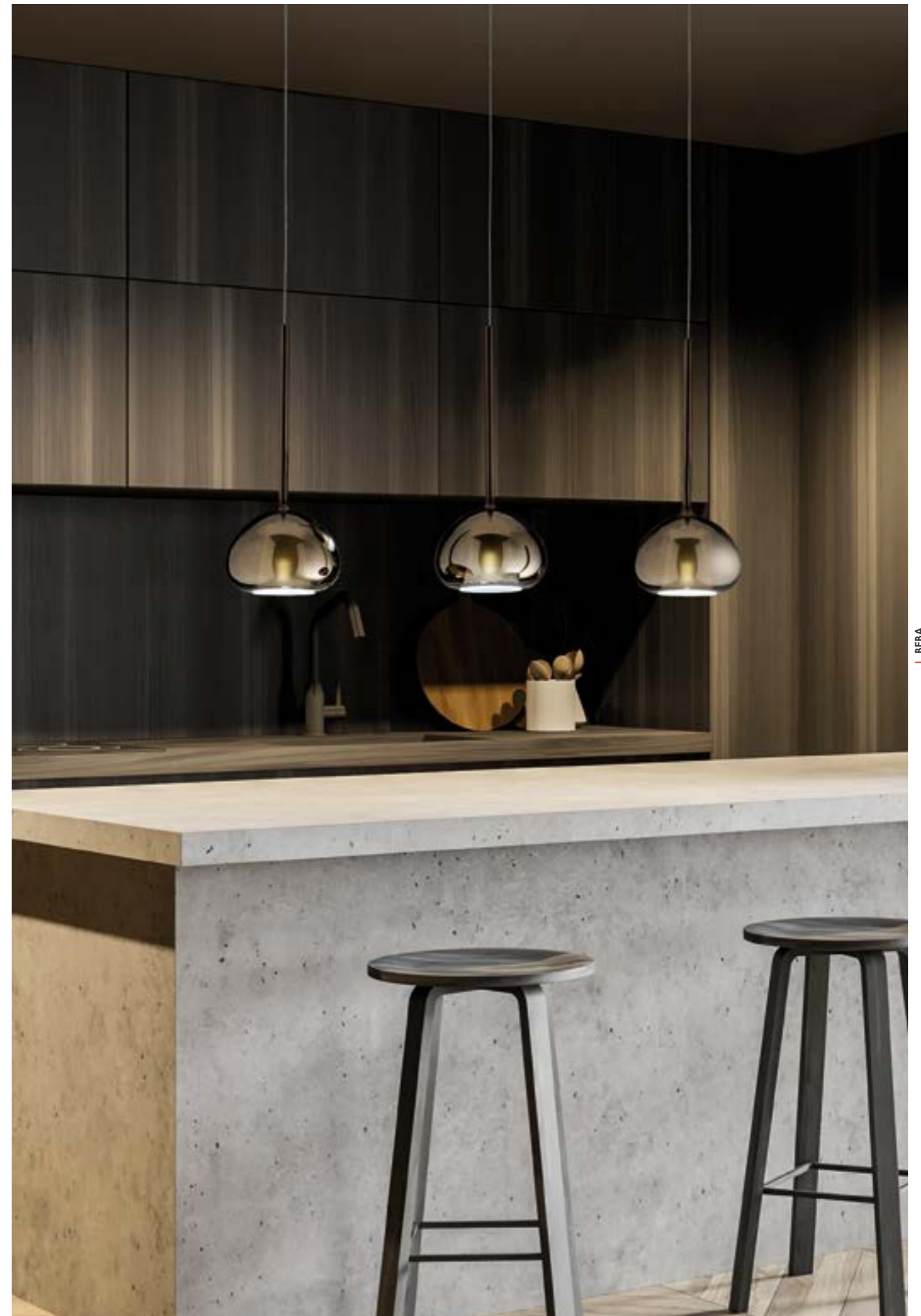



BEBA SUSPENSION





BEBA SUSPENSION



BEBA SUSPENSION



BEBA SUSPENSION





BEBA SUSPENSION



BEBA SUSPENSION



1730.M.30



1730.M.34



1730.M.35



1730.M.36



1730.M.40



1730.M.41



1730.M.42

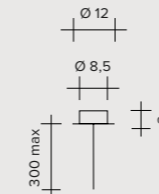

G9 1x max 28W - 230V

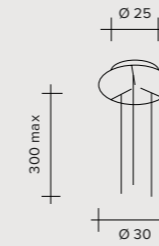

G9 3X max 28W - 230V

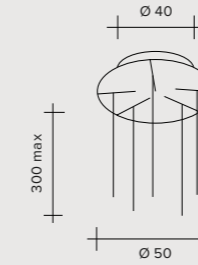

G9 5X max 28W - 230V

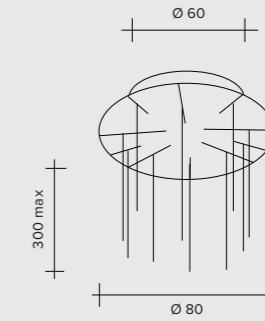

G9 10X max 28W - 230V

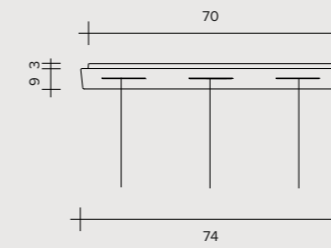

G9 3X max 28W - 230V

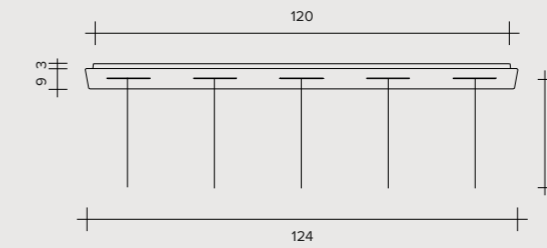

G9 5X max 28W - 230V

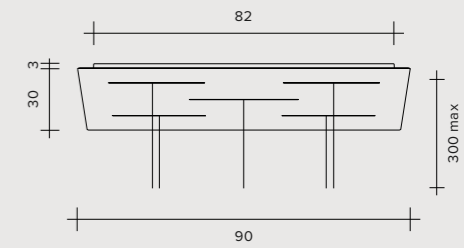

G9 5X max 28W - 230V

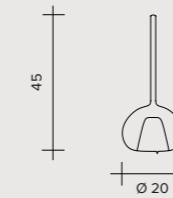
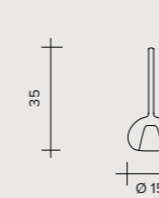

BEBA

Ceiling canopies for modular suspension lamps

Rosoni per composizioni lampade a sospensione

Rosetten für Hängeleuchtenkompositionen

Rosetones para composiciones de lámparas colgantes

Потолочные чаши для композиций из подвесных светильников



FINISHES / FINITURE / FARBE / ACABADOS / ОТДЕЛКИ

GLASS

Vetro / Glas / Vidrio / Стекло

○ Trasparent / Trasparente / Transparent / Transparente / Прозрачный

● Chrome / Cromo / Chrom / Cromo / Хром

● Bronze / Bronzo / Bronze / Bronce / бронза

● Gold / Oro / Kupfe / Gold / Золото

CEILING CANOPY

Rosone / Rosette / Roseta / Потолочные чаши

● Embossed white / Bianco gofrato

● Weiß gaufriert / Blanco gofrado / Белый гофрированный

PRICE LIST

LISTINO PREZZI

PREISLISTE

LISTA DE PRECIOS

ПРАЙС-ЛИСТ

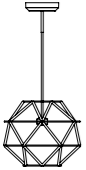
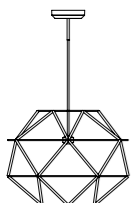
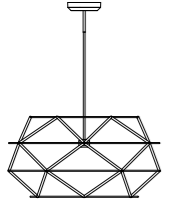
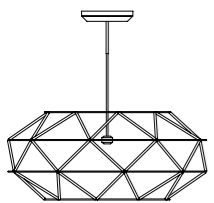
PRODUCT	FINISHES	°K	CODE	PAGE	PRICE € incl VAT (22%)	PRICE € excl VAT
 <p>EUCLIDE Suspension 350</p>	Matt black Nero opaco Mattschwarz Negro mate Матовый черныйеве	2700 °K	1821.30.2700	23	1.043,00	854,92
			1821.30.2700.DP***		1.078,00	883,61
		3000 °K	1821.30.3000		1.043,00	854,92
			1821.30.3000.DP***		1.078,00	883,61
	Gold Oro Gold Oro Золото	2700 °K	1822.30.2700	23	1.043,00	854,92
			1822.30.2700.DP***		1.078,00	883,61
		3000 °K	1822.30.3000		1.043,00	854,92
			1822.30.3000.DP***		1.078,00	883,61
 <p>EUCLIDE Suspension 560</p>	Matt black Nero opaco Mattschwarz Negro mate Матовый черныйеве	2700 °K	1821.31.2700	23	1.399,00	1.146,72
			1821.31.2700.D*		1.434,00	1.175,41
			1821.31.2700.DT**		1.434,00	1.175,41
		3000 °K	1821.31.3000		1.399,00	1.146,72
			1821.31.3000.D*		1.434,00	1.175,41
	Gold Oro Gold Oro Золото	2700 °K	1822.31.2700	23	1.399,00	1.146,72
			1822.31.2700.D*		1.434,00	1.175,41
			1822.31.2700.DT**		1.434,00	1.175,41
		3000 °K	1822.31.3000		1.399,00	1.146,72
			1822.31.3000.D*		1.434,00	1.175,41
 <p>EUCLIDE Suspension 700</p>	Matt black Nero opaco Mattschwarz Negro mate Матовый черныйеве	2700 °K	1821.32.2700	23	1.536,00	1.259,02
			1821.32.2700.D*		1.571,00	1.287,70
			1821.32.2700.DT**		1.571,00	1.287,70
		3000 °K	1821.32.3000		1.536,00	1.259,02
			1821.32.3000.D*		1.571,00	1.287,70
	Gold Oro Gold Oro Золото	2700 °K	1822.32.2700	23	1.536,00	1.259,02
			1822.32.2700.D*		1.571,00	1.287,70
			1822.32.2700.DT**		1.571,00	1.287,70
		3000 °K	1822.32.3000		1.536,00	1.259,02
			1822.32.3000.D*		1.571,00	1.287,70
 <p>EUCLIDE Suspension 920</p>	Matt black Nero opaco Mattschwarz Negro mate Матовый черныйеве	2700 °K	1821.33.2700	23	1.960,00	1.606,56
			1821.33.2700.D*		1.995,00	1.635,25
			1821.33.2700.DT**		1.995,00	1.635,25
		3000 °K	1821.33.3000		1.960,00	1.606,56
			1821.33.3000.D*		1.995,00	1.635,25
	Gold Oro Gold Oro Золото	2700 °K	1822.33.2700	23	1.960,00	1.606,56
			1822.33.2700.D*		1.995,00	1.635,25
			1822.33.2700.DT**		1.995,00	1.635,25
		3000 °K	1822.33.3000		1.960,00	1.606,56
			1822.33.3000.D*		1.995,00	1.635,25

* Dimmable with: Push 0-10V/1-10V/Dali/ normally open button
Dimmerabile con: Push 0-10v / 1-10v/Dali / pulsante normalmente aperto
Dimmbar über: Push 0-10V / 1-10V/Dali / Taste normalerweise offen
Intensidad luminosa regulable con: Push 0-10v / 1-10v/Dali / botón normalmente abierto
Диммируется с помощью Push 0-10в / 1-10в/Dali / с нормально разомкнутой кнопкой

** Dimmable with: Triac
Dimmerabile con: Triac
Dimmbar über: Triac
Intensidad luminosa regulable con: Triac
Диммируется с помощью Triac

*** Dimmable with: Push
Dimmerabile con: Push
Dimmbar über: Push
Intensidad luminosa regulable con: Push
Диммируется с помощью Push

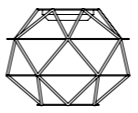
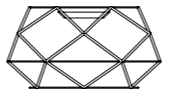
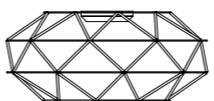

PRODUCT	FINISHES	°K	CODE	PAGE	PRICE € incl VAT (22%)	PRICE € excl VAT
 <p>EUCLIDE Ceiling 350</p>	Matt black Nero opaco Mattschwarz Negro mate Матовый черныйеве	2700 °K	1821.20.2700	33	1.043,00	854,92
			1821.20.2700.DP***		1.143,00	936,89
		3000 °K	1821.20.3000		1.043,00	854,92
			1821.20.3000.DP***		1.143,00	936,89
	Gold Oro Gold Oro Золото	2700 °K	1822.20.2700	33	1.043,00	854,92
			1822.20.2700.DP***		1.143,00	936,89
		3000 °K	1822.20.3000		1.043,00	854,92
			1822.20.3000.DP***		1.143,00	936,89
 <p>EUCLIDE Ceiling 560</p>	Matt black Nero opaco Mattschwarz Negro mate Матовый черныйеве	2700 °K	1821.21.2700	33	1.399,00	1.146,72
			1821.21.2700.D*		1.434,00	1.175,41
			1821.21.2700.DT**		1.434,00	1.175,41
		3000 °K	1821.21.3000		1.399,00	1.146,72
			1821.21.3000.D*		1.434,00	1.175,41
	Gold Oro Gold Oro Золото	2700 °K	1822.21.2700	33	1.399,00	1.146,72
			1822.21.2700.D*		1.434,00	1.175,41
			1822.21.2700.DT**		1.434,00	1.175,41
		3000 °K	1822.21.3000		1.399,00	1.146,72
			1822.21.3000.D*		1.434,00	1.175,41
 <p>EUCLIDE Ceiling 700</p>	Matt black Nero opaco Mattschwarz Negro mate Матовый черныйеве	2700 °K	1821.22.2700	33	1.536,00	1.259,02
			1821.22.2700.D*		1.571,00	1.287,70
			1821.22.2700.DT**		1.571,00	1.287,70
		3000 °K	1821.22.3000		1.536,00	1.259,02
			1821.22.3000.D*		1.571,00	1.287,70
	Gold Oro Gold Oro Золото	2700 °K	1822.22.2700	33	1.536,00	1.259,02
			1822.22.2700.D*		1.571,00	1.287,70
			1822.22.2700.DT**		1.571,00	1.287,70
		3000 °K	1822.22.3000		1.536,00	1.259,02
			1822.22.3000.D*		1.571,00	1.287,70
 <p>EUCLIDE Ceiling 920</p>	Matt black Nero opaco Mattschwarz Negro mate Матовый черныйеве	2700 °K	1821.23.2700	33	1.960,00	1.606,56
			1821.23.2700.D*		1.995,00	1.635,25
			1821.23.2700.DT**		1.995,00	1.635,25
		3000 °K	1821.23.3000		1.960,00	1.606,56
			1821.23.3000.D*		1.995,00	1.635,25
	Gold Oro Gold Oro Золото	2700 °K	1822.23.2700	33	1.960,00	1.606,56
			1822.23.2700.D*		1.995,00	1.635,25
			1822.23.2700.DT**		1.995,00	1.635,25
		3000 °K	1822.23.3000		1.960,00	1.606,56
			1822.23.3000.D*		1.995,00	1.635,25

* Dimmable with: Push 0-10V/1-10V/Dali/ normally open button
Dimmerabile con: Push 0-10v / 1-10v/Dali / pulsante normalmente aperto
Dimmbar über: Push 0-10V / 1-10V/Dali / Taste normalerweise offen
Intensidad luminosa regulable con: Push 0-10v / 1-10v/Dali / botón normalmente abierto
Диммируется с помощью Push 0-10в / 1-10в/Dali / с нормально разомкнутой кнопкой

** Dimmable with: Triac
Dimmerabile con: Triac
Dimmbar über: Triac
Intensidad luminosa regulable con: Triac
Диммируется с помощью Triac



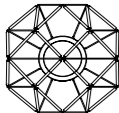

*** Dimmable with: Push
Dimmerabile con: Push
Dimmbar über: Push
Intensidad luminosa regulable con: Push
Диммируется с помощью Push

PRICE LIST_EUCLIDE

PRODUCT	FINISHES	°K	CODE	PAGE	PRICE € incl VAT (22%)	PRICE € excl VAT
 EUCLIDE Wall	Matt black <i>Nero opaco</i> Mattschwarz Negro mate Матовый черный/ве	2700 °K	1821.10.2700	39	732,00	600,00
		3000 °K	1821.10.3000		732,00	600,00
	Gold <i>Oro</i> Gold Oro Золото	2700 °K	1822.10.2700	39	732,00	600,00
		3000 °K	1822.10.3000		732,00	600,00
 EUCLIDE Floor	Matt black <i>Nero opaco</i> Mattschwarz Negro mate Матовый черный/ве	2700 °K	1821.50.2700.D*	43	1.650,00	1.352,46
		3000 °K	1821.50.3000		1.650,00	1.352,46
	Gold <i>Oro</i> Gold Oro Золото	2700 °K	1822.50.2700.D*	43	1.650,00	1.352,46
		3000 °K	1822.50.3000		1.650,00	1.352,46



* Dimmable with: Push 0-10V/1-10V/Dali/ normally open button
 Dimmerabile con: Push 0-10v / 1-10v/Dali / pulsante normalmente aperto
 Dimmbar über: Push 0-10V / 1-10V/Dali / Taste normalerweise offen
 Intensidad luminosa regulable con: Push 0-10v / 1-10v/Dali / botón normalmente abierto
 Диммируется с помощью Push 0-10в / 1-10в/Dali / с нормально разомкнутой кнопкой

PRICE LIST_FILO

PRODUCT	FINISHES	°K	CODE	PAGE	PRICE € incl VAT (22%)	PRICE € excl VAT
 FILO Suspension Ø 50	Matt powder pink <i>Cipria opaco</i> Puderfarben matt Rosa palo mate Пудровый матовый	2700 °K	1839.30.2700	57	1.703,00	1.395,90
			1839.30.2700.D*		1.803,00	1.477,87
	Titanium <i>Titanio</i> Titan Titanio Титан	2700 °K	1840.30.2700	57	1.703,00	1.395,90
		3000 °K	1840.30.3000		1.803,00	1.477,87
 FILO Suspension Ø 70	Matt powder pink <i>Cipria opaco</i> Puderfarben matt Rosa palo mate Пудровый матовый	2700 °K	1839.31.2700	57	2.057,00	1.686,07
			1839.31.2700.D*		2.157,00	1.768,03
	Titanium <i>Titanio</i> Titan Titanio Титан	2700 °K	1840.31.2700	57	2.057,00	1.686,07
		3000 °K	1840.31.3000		2.157,00	1.768,03
 FILO Suspension Ø 90	Matt powder pink <i>Cipria opaco</i> Puderfarben matt Rosa palo mate Пудровый матовый	2700 °K	1839.32.2700	57	2.486,00	2.037,70
			1839.32.2700.D*		2.586,00	2.119,67
	Titanium <i>Titanio</i> Titan Titanio Титан	2700 °K	1840.32.2700	57	2.486,00	2.037,70
		3000 °K	1840.32.3000		2.586,00	2.119,67
 FILO Suspension Ø 110	Matt powder pink <i>Cipria opaco</i> Puderfarben matt Rosa palo mate Пудровый матовый	2700 °K	1839.33.2700	57	3.077,00	2.522,13
			1839.33.2700.D*		3.177,00	2.604,10
	Titanium <i>Titanio</i> Titan Titanio Титан	2700 °K	1840.33.2700	57	3.077,00	2.522,13
		3000 °K	1840.33.3000		3.177,00	2.604,10

* Dimmable with: Push 0-10V/1-10V/Dali/ normally open button
 Dimmerabile con: Push 0-10v / 1-10v/Dali / pulsante normalmente aperto
 Dimmbar über: Push 0-10V / 1-10V/Dali / Taste normalerweise offen
 Intensidad luminosa regulable con: Push 0-10v / 1-10v/Dali / botón normalmente abierto
 Диммируется с помощью Push 0-10в / 1-10в/Dali / с нормально разомкнутой кнопкой

** Dimmable with: Triac
 Dimmerabile con: Triac
 Dimmbar über: Triac
 Intensidad luminosa regulable con: Triac
 Диммируется с помощью Triac

PRODUCT	FINISHES	°K	CODE	PAGE	PRICE € incl VAT (22%)	PRICE € excl VAT
 <p>FILO Ceiling Ø 50</p>	Matt powder pink <i>Cipria opaco</i> Puderfarben matt Rosa palo mate Пудровый матовый	2700 °K	1839.20.2700	65	1.674,00	1.372,13
			1839.20.2700.D*		1.774,00	1.454,10
			1839.20.2700.DT**		1.774,00	1.454,10
		3000 °K	1839.20.3000		1.674,00	1.372,13
			1839.20.3000.D*		1.774,00	1.454,10
			1839.20.3000.DT**		1.774,00	1.454,10
	Titanium <i>Titanio</i> Titan Titanio Титан	2700 °K	1840.20.2700	65	1.674,00	1.372,13
			1840.20.2700.D*		1.774,00	1.454,10
			1840.20.2700.DT**		1.774,00	1.454,10
		3000 °K	1840.20.3000		1.674,00	1.372,13
			1840.20.3000.D*		1.774,00	1.454,10
			1840.20.3000.DT**		1.774,00	1.454,10
 <p>FILO Ceiling Ø 80</p>	Matt powder pink <i>Cipria opaco</i> Puderfarben matt Rosa palo mate Пудровый матовый	2700 °K	1839.21.2700	65	1.731,00	1.418,85
			1839.21.2700.D*		1.831,00	1.500,82
			1839.21.2700.DT**		1.831,00	1.500,82
		3000 °K	1839.21.3000		1.731,00	1.418,85
			1839.21.3000.D*		1.831,00	1.500,82
			1839.21.3000.DT**		1.831,00	1.500,82
	Titanium <i>Titanio</i> Titan Titanio Титан	2700 °K	1840.21.2700	65	1.731,00	1.418,85
			1840.21.2700.D*		1.831,00	1.500,82
			1840.21.2700.DT**		1.831,00	1.500,82
		3000 °K	1840.21.3000		1.731,00	1.418,85
			1840.21.3000.D*		1.831,00	1.500,82
			1840.21.3000.DT**		1.831,00	1.500,82
 <p>FILO Ceiling Ø 100</p>	Matt powder pink <i>Cipria opaco</i> Puderfarben matt Rosa palo mate Пудровый матовый	2700 °K	1839.22.2700	65	2.127,00	1.743,44
			1839.22.2700.D*		2.227,00	1.825,41
			1839.22.2700.DT**		2.227,00	1.825,41
		3000 °K	1839.22.3000		2.127,00	1.743,44
			1839.22.3000.D*		2.227,00	1.825,41
			1839.22.3000.DT**		2.227,00	1.825,41
	Titanium <i>Titanio</i> Titan Titanio Титан	2700 °K	1840.22.2700	65	2.127,00	1.743,44
			1840.22.2700.D*		2.227,00	1.825,41
			1840.22.2700.DT**		2.227,00	1.825,41
		3000 °K	1840.22.3000		2.127,00	1.743,44
			1840.22.3000.D*		2.227,00	1.825,41
			1840.22.3000.DT**		2.227,00	1.825,41

* Dimmable with: Push 0-10V/1-10V/Dali/ normally open button
 Dimmerabile con: Push 0-10v / 1-10v/Dali / pulsante normalmente aperto
 Dimmbar über: Push 0-10V / 1-10V/Dali / Taste normalerweise offen
 Intensidad luminosa regulable con: Push 0-10v / 1-10v/Dali / botón normalmente abierto
 Диммируется с помощью Push 0-10в / 1-10в/Dali / с нормально разомкнутой кнопкой

Surface mounting - Suspension

Luminaire / Corpo illuminante / Beleuchtungskörper / Cuerpo iluminador / Светильник

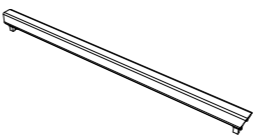
PRODUCT	FINISHES	CM.	W	°K	LUMEN	CODE	PAGE	PRICE € incl VAT (22%)	PRICE € excl VAT		
 <p>CARTESIAN Surface Mounting</p>	Light module <i>Modulo luce</i> Lichtmodul Módulo luminoso Световой модуль 24V - CRI 90	30	5W	2700 °K	400	1832.2.2700	78	49,00	40,16		
				3000 °K	500	1832.2.3000	78	49,00	40,16		
				60	10W	2700 °K	800	1832.3.2700	78	59,00	48,36
						3000 °K	1000	1832.3.3000	78	59,00	48,36
				90	15W	2700 °K	1200	1832.4.2700	78	69,00	56,56
						3000 °K	1500	1832.4.3000	78	69,00	56,56
		120	20W	2700 °K	1600	1832.5.2700	78	79,00	64,75		
				3000 °K	2000	1832.5.3000	78	79,00	64,75		



** Dimmable with: Triac
 Dimmerabile con: Triac
 Dimmbar über: Triac
 Intensidad luminosa regulable con: Triac
 Диммируется с помощью Triac

Accessories

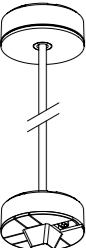
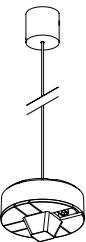
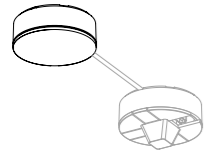
Ceiling canopies and driver / Driver e rosone / Rosette und Driver / Rosetón y driver / Потолочная чашка и драйвер

ACCESSORIES	W	CODE	PRICE € incl VAT (22%)	PRICE € excl VAT
 Cartesian system connection base <i>Basetta di collegamento per sistema Cartesian</i> <i>Anschlussstafel für das System Cartesian</i> <i>Placa de conexión para sistema cartesiano</i> <i>Соединительная планка для системы Cartesian</i>		1832.1	39,00	31,97
 Ceiling canopy with power supply cable <i>Rosone soffitto con cavo di alimentazione</i> <i>Deckenrosette mit Stromkabel</i> <i>Rosetón de techo con cable de alimentación</i> <i>Потолочная чашка с проводом</i>		1832.12	105,00	86,07
 Steel ceiling cable kit <i>Kit cavo acciaio soffitto</i> <i>Deckenkabel-Set aus Stahl</i> <i>Kit de cable de techo de acero</i> <i>Комплект потолочного крепежа из стали</i>		1832.13	79,00	64,75
 Remote driver ceiling canopy <i>Rosone driver remoto</i> <i>Rosette ferngesteuerter Driver</i> <i>Rosetón driver remoto</i> <i>Потолочная чашка с драйвером с пультом ДУ</i>		1832.14	49,00	40,16
Built-in power supply <i>Alimentatore a bordo</i> <i>Integrierte Stromversorgung</i> <i>Fuente de alimentación integrada</i> <i>Встроенный блок питания</i>	60W	1832.6	178,00	145,90
	100W	1832.7	220,00	180,33
	200W	1832.8	308,00	252,46
Dali dimmable push built-in power supply (0-10v, 1-10v) <i>Alimentatore a bordo dimmerabile push, Dali, 0-10v, 1-10v</i> <i>Stromversorgung on board dimmbar Push, Dali, 0-10v, 1-10v</i> <i>Fuente de alimentación integrada regulable push, Dali, 0-10v, 1-10v</i> <i>Диммируемый встроенный блок питания с функцией push и управлением Dali, 0-10 В, 1-10 В</i>	60W Dimmer	1832.9	302,00	247,54
	100W Dimmer	1832.10	345,00	282,79
	200W Dimmer	1832.11	433,00	354,92
Remote ON/OFF power supply <i>Alimentatore remoto On-Off</i> <i>Ferngesteuerte Ein-Aus-Stromversorgung</i> <i>Mando de encendido y apagado</i> <i>Дистанционный блок питания вкл.-выкл</i>	50W SNAPPY	T73.50W.24.SNP	58,00	47,54
	100W SNAPPY	T73.100W.24.SNP	108,00	88,52
	150W SNAPPY	T73.150W.24.SNP	102,00	83,61
	200W SNAPPY	T73.200W.24.SNP	163,00	133,61
	320W SNAPPY	T73.320W.24.SNP	237,00	194,26
Dimmable remote power supply (1-10v). <i>Alimentatore remoto dimmerabile 1-10v</i> <i>Fernbedienbare dimmbare 1-10-V-Stromversorgung.</i> <i>Mando de regulación 1-10v</i> <i>Диммируемый дистанционный блок питания 1-10 В</i>	40W DIMMERABLE	T73.40W.24.DIM	97,00	79,51
	100W DIMMERABLE	T73.100W.24.DIM	146,00	119,67
	150W DIMMERABLE	T73.150W.24.DIM	153,00	125,41
	200W DIMMERABLE	T73.200W.24.DIM	192,00	157,38
	320W DIMMERABLE	T73.320W.24.DIM	261,00	213,93

PRODUCT	FINISHES	°K	CODE	PAGE	PRICE € incl VAT (22%)	PRICE € excl VAT
 EG Wall Ceiling 390	Turtledove grey <i>Tortora</i> <i>Taubengrau</i> <i>Gris paloma</i> <i>Tayn</i>	3000 °K	1828.20	95	313,00	256,56
	Dark grey <i>Grigio scuro</i> <i>Dunkelgrau</i> <i>Gris oscuro</i> <i>Темно-серый</i>	3000 °K	1829.20	95	313,00	256,56
	White <i>Bianco</i> <i>Weiß</i> <i>Blanco</i> <i>Белый цвет</i>	3000 °K	1830.20	95	313,00	256,56
 EG Wall Ceiling 560	Turtledove grey <i>Tortora</i> <i>Taubengrau</i> <i>Gris paloma</i> <i>Tayn</i>	3000 °K	1828.21	95	439,00	359,84
	Dark grey <i>Grigio scuro</i> <i>Dunkelgrau</i> <i>Gris oscuro</i> <i>Темно-серый</i>	3000 °K	1829.21	95	439,00	359,84
	White <i>Bianco</i> <i>Weiß</i> <i>Blanco</i> <i>Белый цвет</i>	3000 °K	1830.21	95	439,00	359,84
 EG Wall Ceiling 760	Turtledove grey <i>Tortora</i> <i>Taubengrau</i> <i>Gris paloma</i> <i>Tayn</i>	3000 °K	1828.22	95	632,00	518,03
	Dark grey <i>Grigio scuro</i> <i>Dunkelgrau</i> <i>Gris oscuro</i> <i>Темно-серый</i>	3000 °K	1829.22	95	632,00	518,03
	White <i>Bianco</i> <i>Weiß</i> <i>Blanco</i> <i>Белый цвет</i>	3000 °K	1830.22	95	632,00	518,03

PRODUCT	FINISHES	°K	CODE	PAGE	PRICE € incl VAT (22%)	PRICE € excl VAT
 <p>ANELLO Suspension Ø 55</p>	Painted black <i>Nero Verniciato Schwarz lackiert Negro Pintado Окрашенный в черный цвет</i>	2700 °K	1790.30.2700	121	693,00	568,03
			1790.30.2700.D*		793,00	650,00
		3000 °K	1790.30.3000		693,00	568,03
			1790.30.3000.D*		793,00	650,00
	Brushed bronze <i>Bronzo spazzolato Bronze gebürstet Bronce cepillado Брашированная бронза</i>	2700 °K	1799.30.2700	121	693,00	568,03
			1799.30.2700.D*		793,00	650,00
		3000 °K	1799.30.3000		693,00	568,03
			1799.30.3000.D*		793,00	650,00
	Brushed gold <i>Oro spazzolato Gold gebürstet Oro cepillado Брашированное золото</i>	2700 °K	1800.30.2700	121	693,00	568,03
			1800.30.2700.D*		793,00	650,00
		3000 °K	1800.30.3000		693,00	568,03
			1800.30.3000.D*		793,00	650,00
Brushed copper <i>Rame spazzolato Kupfer gebürstet Cobre cepillado Брашированная медь</i>	2700 °K	1801.30.2700	121	693,00	568,03	
		1801.30.2700.D*		793,00	650,00	
	3000 °K	1801.30.3000		693,00	568,03	
		1801.30.3000.D*		793,00	650,00	
 <p>ANELLO Suspension Ø 78</p>	Painted black <i>Nero Verniciato Schwarz lackiert Negro Pintado Окрашенный в черный цвет</i>	2700 °K	1790.31.2700	121	852,00	698,36
			1790.31.2700.D*		952,00	780,33
			1790.31.2700.DT**		952,00	780,33
		3000 °K	1790.31.3000		852,00	698,36
			1790.31.3000.D*		952,00	780,33
			1790.31.3000.DT**		952,00	780,33
	Brushed bronze <i>Bronzo spazzolato Bronze gebürstet Bronce cepillado Брашированная бронза</i>	2700 °K	1799.31.2700	121	852,00	698,36
			1799.31.2700.D*		952,00	780,33
			1799.31.2700.DT**		952,00	780,33
		3000 °K	1799.31.3000		852,00	698,36
			1799.31.3000.D*		952,00	780,33
			1799.31.3000.DT**		952,00	780,33
	Brushed gold <i>Oro spazzolato Gold gebürstet Oro cepillado Брашированное золото</i>	2700 °K	1800.31.2700	121	852,00	698,36
			1800.31.2700.D*		952,00	780,33
			1800.31.2700.DT**		952,00	780,33
		3000 °K	1800.31.3000		852,00	698,36
			1800.31.3000.D*		952,00	780,33
			1800.31.3000.DT**		952,00	780,33
	Brushed copper <i>Rame spazzolato Kupfer gebürstet Cobre cepillado Брашированная медь</i>	2700 °K	1801.31.2700	121	852,00	698,36
			1801.31.2700.D*		952,00	780,33
			1801.31.2700.DT**		952,00	780,33
		3000 °K	1801.31.3000		852,00	698,36
			1801.31.3000.D*		952,00	780,33
			1801.31.3000.DT**		952,00	780,33

* Dimmable with: Push 0-10V/1-10V/Dali/ normally open button
 Dimmerabile con: Push 0-10v / 1-10v/Dali / pulsante normalmente aperto
 Dimmbar über: Push 0-10V / 1-10V/Dali / Taste normalerweise offen
 Intensidad luminosa regulable con: Push 0-10v / 1-10v/Dali / botón normalmente abierto
 Диммируется с помощью Push 0-10v / 1-10v/Dali / с нормально разомкнутой кнопкой

** Dimmable with: Triac
 Dimmerabile con: Triac
 Dimmbar über: Triac
 Intensidad luminosa regulable con: Triac
 Диммируется с помощью Triac

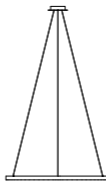
PRODUCT	FINISHES	°K	CODE	PAGE	PRICE € incl VAT (22%)	PRICE € excl VAT
 <p>ANELLO Suspension Ø 109</p>	Painted black <i>Nero Verniciato Schwarz lackiert Negro Pintado Окрашенный в черный цвет</i>	2700 °K	1790.32.2700	121	1.028,00	842,62
			1790.32.2700.D*		1.128,00	924,59
			1790.32.2700.DT**		1.128,00	924,59
		3000 °K	1790.32.3000		1.028,00	842,62
			1790.32.3000.D*		1.128,00	924,59
			1790.32.3000.DT**		1.128,00	924,59
	Brushed bronze <i>Bronzo spazzolato Bronze gebürstet Bronce cepillado Брашированная бронза</i>	2700 °K	1799.32.2700	121	1.028,00	842,62
			1799.32.2700.D*		1.128,00	924,59
			1799.32.2700.DT**		1.128,00	924,59
		3000 °K	1799.32.3000		1.028,00	842,62
			1799.32.3000.D*		1.128,00	924,59
			1799.32.3000.DT**		1.128,00	924,59
	Brushed gold <i>Oro spazzolato Gold gebürstet Oro cepillado Брашированное золото</i>	2700 °K	1800.32.2700	121	1.028,00	842,62
			1800.32.2700.D*		1.128,00	924,59
			1800.32.2700.DT**		1.128,00	924,59
		3000 °K	1800.32.3000		1.028,00	842,62
			1800.32.3000.D*		1.128,00	924,59
			1800.32.3000.DT**		1.128,00	924,59
	Brushed copper <i>Rame spazzolato Kupfer gebürstet Cobre cepillado Брашированная медь</i>	2700 °K	1801.32.2700	121	1.028,00	842,62
			1801.32.2700.D*		1.128,00	924,59
			1801.32.2700.DT**		1.128,00	924,59
		3000 °K	1801.32.3000		1.028,00	842,62
			1801.32.3000.D*		1.128,00	924,59
			1801.32.3000.DT**		1.128,00	924,59

* Dimmable with: Push 0-10V/1-10V/Dali/ normally open button
 Dimmerabile con: Push 0-10v / 1-10v/Dali / pulsante normalmente aperto
 Dimmbar über: Push 0-10V / 1-10V/Dali / Taste normalerweise offen
 Intensidad luminosa regulable con: Push 0-10v / 1-10v/Dali / botón normalmente abierto
 Диммируется с помощью Push 0-10v / 1-10v/Dali / с нормально разомкнутой кнопкой

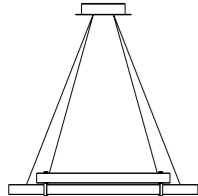

** Dimmable with: Triac
 Dimmerabile con: Triac
 Dimmbar über: Triac
 Intensidad luminosa regulable con: Triac
 Диммируется с помощью Triac

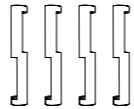
PRODUCT	FINISHES	°K	CODE	PAGE	PRICE € incl VAT (22%)	PRICE € excl VAT
 <p>ANELLO Double Suspension (Rings only joint kit not included)</p> <p>Rings only, joint kit not included. <i>Solo anelli. Joint Kit non incluso. Nur Ringe, Join Kit nicht inbegriffen. Solo anillos, kit de junta no incluido. Только кольца, соединительный комплект не входит в поставку.</i></p>	Painted black <i>Nero Verniciato</i> Schwarz lackiert Negro Pintado Окрашенный в черный цвет	2700 °K	1790.33.2700	131	1.546,00	1.267,21
			1790.33.2700.D*		1.646,00	1.349,18
			1790.33.2700.DT**		1.646,00	1.349,18
		3000 °K	1790.33.3000		1.546,00	1.267,21
			1790.33.3000.D*		1.646,00	1.349,18
			1790.33.3000.DT**		1.646,00	1.349,18
	Brushed bronze <i>Bronzo spazzolato</i> Bronze gebürstet Bronce cepillado Брашированная бронза	2700 °K	1799.33.2700	131	1.546,00	1.267,21
			1799.33.2700.D*		1.646,00	1.349,18
			1799.33.2700.DT**		1.646,00	1.349,18
		3000 °K	1799.33.3000		1.546,00	1.267,21
			1799.33.3000.D*		1.646,00	1.349,18
			1799.33.3000.DT**		1.646,00	1.349,18
	Brushed gold <i>Oro spazzolato</i> Gold gebürstet Oro cepillado Брашированное золото	2700 °K	1800.33.2700	131	1.546,00	1.267,21
			1800.33.2700.D*		1.646,00	1.349,18
			1800.33.2700.DT**		1.646,00	1.349,18
		3000 °K	1800.33.3000		1.546,00	1.267,21
			1800.33.3000.D*		1.646,00	1.349,18
			1800.33.3000.DT**		1.646,00	1.349,18
Brushed copper <i>Rame spazzolato</i> Kupfer gebürstet Cobre cepillado Брашированная медь	2700 °K	1801.33.2700	131	1.546,00	1.267,21	
		1801.33.2700.D*		1.646,00	1.349,18	
		1801.33.2700.DT**		1.646,00	1.349,18	
	3000 °K	1801.33.3000		1.546,00	1.267,21	
		1801.33.3000.D*		1.646,00	1.349,18	
		1801.33.3000.DT**		1.646,00	1.349,18	

PRODUCT	FINISHES	°K	CODE	PAGE	PRICE € incl VAT (22%)	PRICE € excl VAT							
 <p>JOINT KIT Double Suspension</p>	Set of two clasps for Black Anello series Suspension. Set due ganci per sospensione serie Anello colore Nero . Satz mit zwei Haken für die Aufhängung Serie Anello Farbe Schwarz . Juego de dos ganchos para suspensión serie Anello color negro . Комплект из двух зажимов для Подвесного элемента серии Anello цвет Черный .	1825.BLACK	131	66,00	54,10								
				Set of two clasps for Gold Anello series Suspension. Set due ganci per sospensione serie Anello colore Oro . Satz mit zwei Haken für die Aufhängung Serie Anello Farbe Gold . Juego de dos ganchos para suspensión serie Anello color oro . Комплект из двух зажимов для Подвесного элемента серии Anello цвет Золотистый .	1825.GOLD	66,00	54,10						
						Set of two clasps for Copper Anello series Suspension. Set due ganci per sospensione serie Anello colore Rame . Satz mit zwei Haken für die Aufhängung Serie Anello Farbe Kupfer . Juego de dos ganchos para suspensión serie Anello color cobre . Комплект из двух зажимов для Подвесного элемента серии Anello цвет Медный .	1825.COPPER	66,00	54,10				
								Set of two clasps for Aluminium Anello series Suspension. Set due ganci per sospensione serie Anello colore Alluminio . Satz mit zwei Haken für die Aufhängung Serie Anello Farbe Aluminium . Juego de dos ganchos para suspensión serie Anello color aluminio . Комплект из двух зажимов для Подвесного элемента серии Anello цвет Алюминиевый .	1825.ALLUM	66,00	54,10		
										Set of two clasps for Bronze Anello series Suspension. Set due ganci per sospensione serie Anello colore Bronzo . Satz mit zwei Haken für die Aufhängung Serie Anello Farbe Bronze . Juego de dos ganchos para suspensión serie Anello color Bronce . Комплект из двух зажимов для Подвесного элемента серии Anello цвет Бронзовый .	1825.BRONZ	66,00	54,10

* Dimmable with: Push 0-10V/1-10V/Dali/ normally open button
Dimmerabile con: Push 0-10v / 1-10v/Dali / pulsante normalmente aperto
Dimmbar über: Push 0-10V / 1-10V/Dali / Taste normalerweise offen
Intensidad luminosa regulable con: Push 0-10v / 1-10v/Dali / botón normalmente abierto
Диммируется с помощью Push 0-10v / 1-10v/Dali / с нормально разомкнутой кнопкой

** Dimmable with: Triac
Dimmerabile con: Triac
Dimmbar über: Triac
Intensidad luminosa regulable con: Triac
Диммируется с помощью Triac

PRODUCT	FINISHES	°K	CODE	PAGE	PRICE € incl VAT (22%)	PRICE € excl VAT
 <p>ANELLO Ceiling Ø 55</p>	Painted black <i>Nero Verniciato</i> <i>Schwarz lackiert</i> <i>Negro Pintado</i> <i>Окрашенный в черный цвет</i>	2700 °K	1790.20.2700	109	858,00	703,28
			1790.20.2700.D*		958,00	785,25
		3000 °K	1790.20.3000		858,00	703,28
			1790.20.3000.D*		958,00	785,25
	Brushed bronze <i>Bronzo spazzolato</i> <i>Bronze gebürstet</i> <i>Bronce cepillado</i> <i>Брашированная бронза</i>	2700 °K	1799.20.2700	109	858,00	703,28
			1799.20.2700.D*		958,00	785,25
		3000 °K	1799.20.3000		858,00	703,28
			1799.20.3000.D*		958,00	785,25
	Brushed gold <i>Oro spazzolato</i> <i>Gold gebürstet</i> <i>Oro cepillado</i> <i>Брашированное золото</i>	2700 °K	1800.20.2700	109	858,00	703,28
			1800.20.2700.D*		958,00	785,25
		3000 °K	1800.20.3000		858,00	703,28
			1800.20.3000.D*		958,00	785,25
Brushed copper <i>Rame spazzolato</i> <i>Kupfer gebürstet</i> <i>Cobre cepillado</i> <i>Брашированная медь</i>	2700 °K	1801.20.2700	109	858,00	703,28	
		1801.20.2700.D*		958,00	785,25	
	3000 °K	1801.20.3000		858,00	703,28	
		1801.20.3000.D*		958,00	785,25	
 <p>ANELLO Ceiling Ø 78</p>	Painted black <i>Nero Verniciato</i> <i>Schwarz lackiert</i> <i>Negro Pintado</i> <i>Окрашенный в черный цвет</i>	2700 °K	1790.21.2700	109	1.044,00	855,74
			1790.21.2700.D*		1.144,00	937,70
			1790.21.2700.DT**		1.144,00	937,70
		3000 °K	1790.21.3000		1.044,00	855,74
			1790.21.3000.D*		1.144,00	937,70
			1790.21.3000.DT**		1.144,00	937,70
	Brushed bronze <i>Bronzo spazzolato</i> <i>Bronze gebürstet</i> <i>Bronce cepillado</i> <i>Брашированная бронза</i>	2700 °K	1799.21.2700	109	1.044,00	855,74
			1799.21.2700.D*		1.144,00	937,70
			1799.21.2700.DT**		1.144,00	937,70
		3000 °K	1799.21.3000		1.044,00	855,74
			1799.21.3000.D*		1.144,00	937,70
			1799.21.3000.DT**		1.144,00	937,70
	Brushed gold <i>Oro spazzolato</i> <i>Gold gebürstet</i> <i>Oro cepillado</i> <i>Брашированное золото</i>	2700 °K	1800.21.2700	109	1.044,00	855,74
			1800.21.2700.D*		1.144,00	937,70
			1800.21.2700.DT**		1.144,00	937,70
		3000 °K	1800.21.3000		1.044,00	855,74
			1800.21.3000.D*		1.144,00	937,70
			1800.21.3000.DT**		1.144,00	937,70
	Brushed copper <i>Rame spazzolato</i> <i>Kupfer gebürstet</i> <i>Cobre cepillado</i> <i>Брашированная медь</i>	2700 °K	1801.21.2700	109	1.044,00	855,74
			1801.21.2700.D*		1.144,00	937,70
			1801.21.2700.DT**		1.144,00	937,70
		3000 °K	1801.21.3000		1.044,00	855,74
			1801.21.3000.D*		1.144,00	937,70
			1801.21.3000.DT**		1.144,00	937,70

* Dimmable with: Push 0-10V/1-10V/Dali/ normally open button
 Dimmerabile con: Push 0-10v / 1-10v/Dali / pulsante normalmente aperto
 Dimmbar über: Push 0-10V / 1-10V/Dali / Taste normalerweise offen
 Intensidad luminosa regulable con: Push 0-10v / 1-10v/Dali / botón normalmente abierto
 Диммируется с помощью Push 0-10v / 1-10v/Dali / с нормально разомкнутой кнопкой

** Dimmable with: Triac
 Dimmerabile con: Triac
 Dimmbar über: Triac
 Intensidad luminosa regulable con: Triac
 Диммируется с помощью Triac

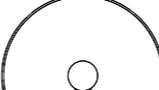
PRODUCT	FINISHES	°K	CODE	PAGE	PRICE € incl VAT (22%)	PRICE € excl VAT
 <p>ANELLO Ceiling Ø 109</p>	Painted black <i>Nero Verniciato</i> <i>Schwarz lackiert</i> <i>Negro Pintado</i> <i>Окрашенный в черный цвет</i>	2700 °K	1790.22.2700	109	1.301,00	1.066,39
			1790.22.2700.D*		1.401,00	1.148,36
			1790.22.2700.DT**		1.401,00	1.148,36
		3000 °K	1790.22.3000		1.301,00	1.066,39
			1790.22.3000.D*		1.401,00	1.148,36
			1790.22.3000.DT**		1.401,00	1.148,36
	Brushed bronze <i>Bronzo spazzolato</i> <i>Bronze gebürstet</i> <i>Bronce cepillado</i> <i>Брашированная бронза</i>	2700 °K	1799.22.2700	109	1.301,00	1.066,39
			1799.22.2700.D*		1.401,00	1.148,36
			1799.22.2700.DT**		1.401,00	1.148,36
		3000 °K	1799.22.3000		1.301,00	1.066,39
			1799.22.3000.D*		1.401,00	1.148,36
			1799.22.3000.DT**		1.401,00	1.148,36
	Brushed gold <i>Oro spazzolato</i> <i>Gold gebürstet</i> <i>Oro cepillado</i> <i>Брашированное золото</i>	2700 °K	1800.22.2700	109	1.301,00	1.066,39
			1800.22.2700.D*		1.401,00	1.148,36
			1800.22.2700.DT**		1.401,00	1.148,36
		3000 °K	1800.22.3000		1.301,00	1.066,39
			1800.22.3000.D*		1.401,00	1.148,36
			1800.22.3000.DT**		1.401,00	1.148,36
	Brushed copper <i>Rame spazzolato</i> <i>Kupfer gebürstet</i> <i>Cobre cepillado</i> <i>Брашированная медь</i>	2700 °K	1801.22.2700	109	1.301,00	1.066,39
			1801.22.2700.D*		1.401,00	1.148,36
			1801.22.2700.DT**		1.401,00	1.148,36
		3000 °K	1801.22.3000		1.301,00	1.066,39
			1801.22.3000.D*		1.401,00	1.148,36
			1801.22.3000.DT**		1.401,00	1.148,36

* Dimmable with: Push 0-10V/1-10V/Dali/ normally open button
 Dimmerabile con: Push 0-10v / 1-10v/Dali / pulsante normalmente aperto
 Dimmbar über: Push 0-10V / 1-10V/Dali / Taste normalerweise offen
 Intensidad luminosa regulable con: Push 0-10v / 1-10v/Dali / botón normalmente abierto
 Диммируется с помощью Push 0-10v / 1-10v/Dali / с нормально разомкнутой кнопкой

** Dimmable with: Triac
 Dimmerabile con: Triac
 Dimmbar über: Triac
 Intensidad luminosa regulable con: Triac
 Диммируется с помощью Triac

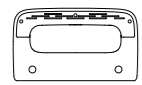
PRODUCT	FINISHES	°K	CODE	PAGE	PRICE € incl VAT (22%)	PRICE € excl VAT
 22,3 cm AKI Wall	White Bianco Weiß Blanco Белый цвет	2700 °K	1796.10.2700	147	292,00	239,34
			1796.10.2700.DP*		382,00	313,11
		3000 °K	1796.10.3000		292,00	239,34
			1796.10.3000.DP*		382,00	313,11
		4000 °K	1796.10.4000		292,00	239,34
			1796.10.4000.DP*		382,00	313,11
	Gold Oro Gold Oro Золото	2700 °K	1841.10.2700	147	292,00	239,34
			1841.10.2700.DP*		382,00	313,11
		3000 °K	1841.10.3000		292,00	239,34
			1841.10.3000.DP*		382,00	313,11
		4000 °K	1841.10.4000		292,00	239,34
			1841.10.4000.DP*		382,00	313,11
	Copper Rame Kupfe Сobre Медь	2700 °K	1835.10.2700	147	292,00	239,34
			1835.10.2700.DP*		382,00	313,11
		3000 °K	1835.10.3000		292,00	239,34
			1835.10.3000.DP*		382,00	313,11
		4000 °K	1835.10.4000		292,00	239,34
			1835.10.4000.DP*		382,00	313,11
	Bronze Bronzo Bronze Bronze бронза	2700 °K	1798.10.2700	147	292,00	239,34
			1798.10.2700.DP*		382,00	313,11
		3000 °K	1798.10.3000		292,00	239,34
			1798.10.3000.DP*		382,00	313,11
		4000 °K	1798.10.4000		292,00	239,34
			1798.10.4000.DP*		382,00	313,11
Anthracite grey Antracite Anthrazitfarben Antracita Антрацит	2700 °K	1823.10.2700	147	292,00	239,34	
		1823.10.2700.DP*		382,00	313,11	
	3000 °K	1823.10.3000		292,00	239,34	
		1823.10.3000.DP*		382,00	313,11	
	4000 °K	1823.10.4000		292,00	239,34	
		1823.10.4000.DP*		382,00	313,11	

* Dimmable with Push
 Dimmerabile con Push
 Dimmbar über Push
 Intensidad luminosa regulable con Push
 Диммируется с помощью Push

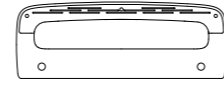
PRODUCT	FINISHES	°K	CODE	PAGE	PRICE € incl VAT (22%)	PRICE € excl VAT
 35,5 cm AKI Wall	White Bianco Weiß Blanco Белый цвет	2700 °K	1796.11.2700	147	354,00	290,16
			1796.11.2700.DP*		444,00	363,93
		3000 °K	1796.11.3000		354,00	290,16
			1796.11.3000.DP*		444,00	363,93
		4000 °K	1796.11.4000		354,00	290,16
			1796.11.4000.DP*		444,00	363,93
	Gold Oro Gold Oro Золото	2700 °K	1841.11.2700	147	354,00	290,16
			1841.11.2700.DP*		444,00	363,93
		3000 °K	1841.11.3000		354,00	290,16
			1841.11.3000.DP*		444,00	363,93
		4000 °K	1841.11.4000		354,00	290,16
			1841.11.4000.DP*		444,00	363,93
	Copper Rame Kupfe Сobre Медь	2700 °K	1835.11.2700	147	354,00	290,16
			1835.11.2700.DP*		444,00	363,93
		3000 °K	1835.11.3000		354,00	290,16
			1835.11.3000.DP*		444,00	363,93
		4000 °K	1835.11.4000		354,00	290,16
			1835.11.4000.DP*		444,00	363,93
	Bronze Bronzo Bronze Bronze бронза	2700 °K	1798.11.2700	147	354,00	290,16
			1798.11.2700.DP*		444,00	363,93
		3000 °K	1798.11.3000		354,00	290,16
			1798.11.3000.DP*		444,00	363,93
		4000 °K	1798.11.4000		354,00	290,16
			1798.11.4000.DP*		444,00	363,93
Anthracite grey Antracite Anthrazitfarben Antracita Антрацит	2700 °K	1823.11.2700	147	354,00	290,16	
		1823.11.2700.DP*		444,00	363,93	
	3000 °K	1823.11.3000		354,00	290,16	
		1823.11.3000.DP*		444,00	363,93	
	4000 °K	1823.11.4000		354,00	290,16	
		1823.11.4000.DP*		444,00	363,93	

* Dimmable with Push
 Dimmerabile con Push
 Dimmbar über Push
 Intensidad luminosa regulable con Push
 Диммируется с помощью Push

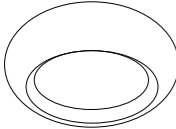
PRODUCT	FINISHES	°K	CODE	PAGE	PRICE € incl VAT (22%)	PRICE € excl VAT
 OLO Wall	White <i>Bianco</i> Weiß <i>Blanco</i> Белый цвет	2700 °K	1776.10.2700	163	293,00	240,16
		3000 °K	1776.10.3000		293,00	240,16
		4000 °K	1776.10.4000		293,00	240,16
	Brushed gold <i>Oro spazzolato</i> <i>Gold gebürstet</i> <i>Oro cepillado</i> Брашированное золото	2700 °K	1791.10.2700	163	293,00	240,16
		3000 °K	1791.10.3000		293,00	240,16
		4000 °K	1791.10.4000		293,00	240,16
	Brushed copper <i>Rame spazzolato</i> <i>Kupfer gebürstet</i> <i>Cobre cepillado</i> Брашированная медь	2700 °K	1792.10.2700	163	293,00	240,16
		3000 °K	1792.10.3000		293,00	240,16
		4000 °K	1792.10.4000		293,00	240,16
	Brushed bronze <i>Bronzo spazzolato</i> <i>Bronze gebürstet</i> <i>Bronce cepillado</i> Брашированная бронза	2700 °K	1793.10.2700	163	293,00	240,16
		3000 °K	1793.10.3000		293,00	240,16
		4000 °K	1793.10.4000		293,00	240,16
Anthracite grey <i>Antracite</i> <i>Anthrazitfarben</i> <i>Antracita</i> Антрацит	2700 °K	1824.10.2700	163	293,00	240,16	
	3000 °K	1824.10.3000		293,00	240,16	
	4000 °K	1824.10.4000		293,00	240,16	

PRODUCT	CODE	PAGE	PRICE € incl VAT (22%)	PRICE € excl VAT
Remote dimmer controller. Controls up to 6 lamps <i>Dimmer remoto. Gestisce fino a 6 lampade</i> <i>Dimmer Fernbedienung. Verwaltet bis zu 6 Leuchten</i> <i>Dimmer remoto. Controla hasta 6 bombillas</i> Диммер дистанционного управления. Управляет максимум 6 лампами	1776.DIM	163	125,00	102,46
Casambi dimmer controller. Controls up to 4 lamps <i>Dimmer casambi. Gestisce fino a 4 lampade</i> <i>Casambi Dimmer Bedienung. Verwaltet bis zu 4 Leuchten</i> <i>Dimmer casambi. Controla hasta 4 bombillas</i> Контроллер-диммер Casambi. Управляет максимум 4 лампами	1776.CASAMBI		175,00	143,44

Wall-wall mounting

Montaggio Parete/Parete, installazione "Tesata" / Wand/Wand Montage, Installationsmethode "Tesata" /
Montaje en Pared/Pared, instalación "Tesata" / Монтаж от стены до стены, установка с натяжкой

MODEL	PRODUCT
Remote power supply / Alimentatore remoto / Entfernt liegendes Netzteil / Fuente de alimentación remota / Источник дистанционного питания	
A	
B	
C	
On-device power supply / Alimentatore a bordo / Integriertes Netzteil / Con fuente de alimentación / Встроенный блок питания	
D	
E	

Wall-wall

Luminaire / Corpo illuminante / Beleuchtungskörper / Cuerpo iluminador / Светильник

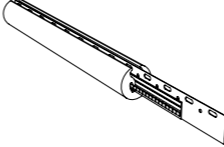
PRODUCT	FINISHES	MT.	°K	CODE	PAGE	PRICE € incl VAT (22%)	PRICE € excl VAT
	Complete LED line, steel, silicone Linea completa Led, Acciaio, Silicone Linea, komplett mit LED, Stahl & Silikon Linea completa led, acero, silicona Комплексная линия, включающая светодиоды, сталь, силикон	1	2700 °K	1795.L1.2700	175	234,00	191,80
		2	2700 °K	1795.L2.2700	175	387,00	317,21
		3	2700 °K	1795.L3.2700	175	539,00	441,80
		4	2700 °K	1795.L4.2700	175	710,00	581,97
		5	2700 °K	1795.L5.2700	175	862,00	706,56
		6	2700 °K	1795.L6.2700	175	1.015,00	831,97
		7	2700 °K	1795.L7.2700	175	1.187,00	972,95
		8	2700 °K	1795.L8.2700	175	1.339,00	1.097,54
		9	2700 °K	1795.L9.2700	175	1.491,00	1.222,13
		10	2700 °K	1795.L10.2700	175	1.644,00	1.347,54
		1	3000 °K	1795.L1.3000	175	234,00	191,80
		2	3000 °K	1795.L2.3000	175	387,00	317,21
		3	3000 °K	1795.L3.3000	175	539,00	441,80
		4	3000 °K	1795.L4.3000	175	710,00	581,97
		5	3000 °K	1795.L5.3000	175	862,00	706,56
		6	3000 °K	1795.L6.3000	175	1.015,00	831,97
		7	3000 °K	1795.L7.3000	175	1.187,00	972,95
		8	3000 °K	1795.L8.3000	175	1.339,00	1.097,54
		9	3000 °K	1795.L9.3000	175	1.491,00	1.222,13
		10	3000 °K	1795.L10.3000	175	1.644,00	1.347,54

Wall-wall

Accessories / Accessori / Zubehör / Accesorios / Аксессуары

ACCESSORIES	FINISHES	CODE	PRICE € incl VAT (22%)	PRICE € excl VAT
	Brushed aluminium Alluminio spazzolato Gebürstetes Aluminium Aluminio cepillado Крацованный алюминий	1795.M1	382,00	313,11
	Black Nero Schwarz Negro Чёрный цвет	1810.M1	382,00	313,11
	Sand Sabbia Sandfarben Arena Песочный цвет	1811.M1	382,00	313,11
	Brushed aluminium Alluminio spazzolato Gebürstetes Aluminium Aluminio cepillado Крацованный алюминий	1795.M4	77,00	63,11
	Black Nero Schwarz Negro Чёрный цвет	1810.M4	77,00	63,11
	Sand Sabbia Sandfarben Arena Песочный цвет	1811.M4	77,00	63,11
	Brushed aluminium Alluminio spazzolato Gebürstetes Aluminium Aluminio cepillado Крацованный алюминий	1795.M5	23,00	18,85
	Black Nero Schwarz Negro Чёрный цвет	1810.M5	23,00	18,85
	Sand Sabbia Sandfarben Arena Песочный цвет	1811.M5	23,00	18,85

* Up to 2 m, calculate 2 pcs + (1 x m) / over 3 m, calculate 1 pc + (1 x m) / Fino a 2 m calcolare 2 pcs + (1 x m) / oltre i 3 m calcolare 1 pc + (1 x m) / Bis zu 2 m 2 Stck. berechnen (1 pro m) / bei mehr als 3 m 1 Stck. + (1 pro m) berechnen / Hasta 2 m calcular 2 uds. + (1 x m) / Encima de 3 m calcular 1 ud. + (1 x m) / До 2 м нужно учитывать 2 шт. + (1 x м) / свыше 3 м нужно учитывать 1 шт. + (1 x м)

Wall-wall

Drivers and canopies / Driver e rosoni / Driver und Baldachin / Driver y Floròn / Драйверы и основания

ACCESSORIES	FINISHES	W	Max MT	CODE	PRICE € incl VAT (22%)	PRICE € excl VAT
	Brushed aluminium Alluminio spazzolato Gebürstetes Aluminium Aluminio cepillado Крацованный алюминий	75W On-Off	Max 3.5 mt	1795.B1	140,00	114,75
		150W On-Off	Max 7.5 mt	1795.B2	159,00	130,33
		200W On-Off	Max 10 mt	1795.B3	252,00	206,56
		60W Dimmer	Max 3 mt	1795.B4*	205,00	168,03
		120W Dimmer	Max 6 mt	1795.B5*	260,00	213,11
		240W Dimmer	Max 10 mt	1795.B6*	310,00	254,10
	Black Nero Schwarz Negro Чёрный цвет	75W On-Off	Max 3.5 mt	1810.B1	140,00	114,75
		150W On-Off	Max 7.5 mt	1810.B2	159,00	130,33
		200W On-Off	Max 10 mt	1810.B3	252,00	206,56
		60W Dimmer	Max 3 mt	1810.B4*	205,00	168,03
		120W Dimmer	Max 6 mt	1810.B5*	260,00	213,11
		240W Dimmer	Max 10 mt	1810.B6*	310,00	254,10
Sand Sabbia Sandfarben Arena Песочный цвет	75W On-Off	Max 3.5 mt	1811.B1	140,00	114,75	
	150W On-Off	Max 7.5 mt	1811.B2	159,00	130,33	
	200W On-Off	Max 10 mt	1811.B3	252,00	206,56	
	60W Dimmer	Max 3 mt	1811.B4*	205,00	168,03	
	120W Dimmer	Max 6 mt	1811.B5*	260,00	213,11	
	240W Dimmer	Max 10 mt	1811.B6*	310,00	254,10	
	Remote power supply Alimentatore remoto Entfernt liegendes Netzteil Fuente de alimentación colocada a distancia Удаленный блок питания	75W On-Off	Max 3.5 mt	1795.R1	54,00	44,26
		150W On-Off	Max 7.5 mt	1795.R2	73,00	59,84
		200W On-Off	Max 10 mt	1795.R3	165,00	135,25
		60W Dimmer	Max 3 mt	1795.R4*	113,00	92,62
		120W Dimmer	Max 6 mt	1795.R5*	168,00	137,70
		240W Dimmer	Max 12 mt	1795.R6*	218,00	178,69

* Dimmable with: 1 ~ 10Vdc, 10V PWM signal and resistance
Dimmerabile con: 1 ~ 10Vdc, 10V PWM segnale e resistenza
Dimmbar über: 1~10Vdc, 10V PWM-Signal und Widerstand
Intensidad luminosa regulable con: 1 ~ 10 Vcc, 10 V PWM señal y resistencia
Диммируется с помощью 1 ~ 10Vdc, 10V ШИМ-сигнала и резистора

Surface mounting

Montaggio Superficiale, installazione "Parete-Soffitto" / Aufputzmontage, Installation Wand-Decke /
Montaje en superficie, instalación Pared-Techo / Монтаж на поверхность, установка со стены до потолка

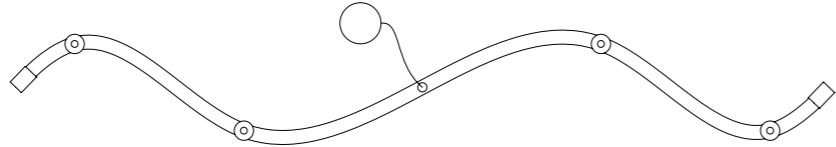
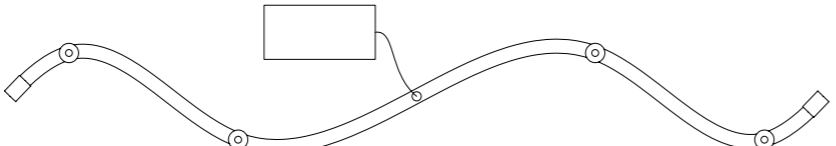
MODEL	PRODUCT
A	
B	

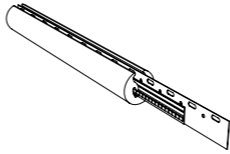

Surface mounting

Luminaire / Corpo illuminante / Beleuchtungskörper / Cuerpo iluminador / Светильник

PRODUCT	FINISHES	MT.	°K	CODE	PAGE	PRICE € incl VAT (22%)	PRICE € excl VAT
	Complete LED line, steel, silicone <i>Linea completa Led, Acciaio, Silicone</i> <i>Linea, komplett mit LED, Stahl & Silikon</i> <i>Linea completa led, acero, silicona</i> <i>Комплексная линия, включающая светодиоды, сталь, силикон</i>	1	2700 °K	1795.L1.2700	185	234,00	191,80
		2	2700 °K	1795.L2.2700	185	387,00	317,21
		3	2700 °K	1795.L3.2700	185	539,00	441,80
		4	2700 °K	1795.L4.2700	185	710,00	581,97
		5	2700 °K	1795.L5.2700	185	862,00	706,56
		6	2700 °K	1795.L6.2700	185	1.015,00	831,97
		7	2700 °K	1795.L7.2700	185	1.187,00	972,95
		8	2700 °K	1795.L8.2700	185	1.339,00	1.097,54
		9	2700 °K	1795.L9.2700	185	1.491,00	1.222,13
		10	2700 °K	1795.L10.2700	185	1.644,00	1.347,54
		1	3000 °K	1795.L1.3000	185	234,00	191,80
		2	3000 °K	1795.L2.3000	185	387,00	317,21
		3	3000 °K	1795.L3.3000	185	539,00	441,80
		4	3000 °K	1795.L4.3000	185	710,00	581,97
		5	3000 °K	1795.L5.3000	185	862,00	706,56
		6	3000 °K	1795.L6.3000	185	1.015,00	831,97
		7	3000 °K	1795.L7.3000	185	1.187,00	972,95
		8	3000 °K	1795.L8.3000	185	1.339,00	1.097,54
		9	3000 °K	1795.L9.3000	185	1.491,00	1.222,13
		10	3000 °K	1795.L10.3000	185	1.644,00	1.347,54

Surface mounting

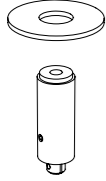
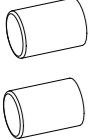
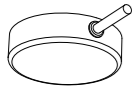
Accessories / Accessori / Zubehör / Accesorios / Аксессуары

ACCESSORIES	FINISHES	CODE	PRICE € incl VAT (22%)	PRICE € excl VAT
	Brushed aluminium Alluminio spazzolato Gebürstetes Aluminium Aluminio cepillado Крацованный алюминий	1795.M2	33,00	27,05
	Black Nero Schwarz Negro Чёрный цвет	1810.M2	33,00	27,05
	Sand Sabbia Sandfarben Arena Песочный цвет	1811.M2	33,00	27,05
	Brushed aluminium Alluminio spazzolato Gebürstetes Aluminium Aluminio cepillado Крацованный алюминий	1795.M3	42,00	34,43
	Black Nero Schwarz Negro Чёрный цвет	1810.M3	42,00	34,43
	Sand Sabbia Sandfarben Arena Песочный цвет	1811.M3	42,00	34,43
	Brushed aluminium Alluminio spazzolato Gebürstetes Aluminium Aluminio cepillado Крацованный алюминий	1795.M4	77,00	63,11
	Black Nero Schwarz Negro Чёрный цвет	1810.M4	77,00	63,11
	Sand Sabbia Sandfarben Arena Песочный цвет	1811.M4	77,00	63,11
	Brushed aluminium Alluminio spazzolato Gebürstetes Aluminium Aluminio cepillado Крацованный алюминий	1795.M5	23,00	18,85
	Black Nero Schwarz Negro Чёрный цвет	1810.M5	23,00	18,85
	Sand Sabbia Sandfarben Arena Песочный цвет	1811.M5	23,00	18,85

* Up to 2 m, calculate 2 pcs + (1 x m) / over 3 m, calculate 1 pc + (1 x m) / Fino a 2 m calcolare 2 pcs + (1 x m) / oltre i 3 m calcolare 1 pc + (1 x m) / Bis zu 2 m 2 Stck. berechnen (1 pro m) / bei mehr als 3 m 1 Stck. + (1 pro m) berechnen / Hasta 2 m calcular 2 uds. + (1 x m) / Encima de 3 m calcular 1 ud. + (1 x m) / До 2 м нужно учитывать 2 шт. + (1 x м) / свыше 3 м нужно учитывать 1 шт. + (1 x м)

Surface mounting

Drivers and canopies / Driver e rosoni / Driver und Baldachin / Driver y Floròn / Драйверы и основания

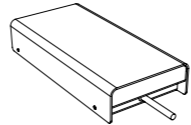
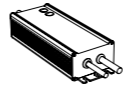
ACCESSORIES	FINISHES	W	Max MT	CODE	PRICE € incl VAT (22%)	PRICE € excl VAT
	Brushed aluminium Alluminio spazzolato Gebürstetes Aluminium Aluminio cepillado Крацованный алюминий	75W On-Off	Max 3.5 mt	1795.B1	140,00	114,75
		150W On-Off	Max 7.5 mt	1795.B2	159,00	130,33
		200W On-Off	Max 10 mt	1795.B3	252,00	206,56
		60W Dimmer	Max 3 mt	1795.B4*	205,00	168,03
		120W Dimmer	Max 6 mt	1795.B5*	260,00	213,11
		240W Dimmer	Max 10 mt	1795.B6*	310,00	254,10
	Black Nero Schwarz Negro Чёрный цвет	75W On-Off	Max 3.5 mt	1810.B1	140,00	114,75
		150W On-Off	Max 7.5 mt	1810.B2	159,00	130,33
		200W On-Off	Max 10 mt	1810.B3	252,00	206,56
		60W Dimmer	Max 3 mt	1810.B4*	205,00	168,03
		120W Dimmer	Max 6 mt	1810.B5*	260,00	213,11
		240W Dimmer	Max 10 mt	1810.B6*	310,00	254,10
Sand Sabbia Sandfarben Arena Песочный цвет	75W On-Off	Max 3.5 mt	1811.B1	140,00	114,75	
	150W On-Off	Max 7.5 mt	1811.B2	159,00	130,33	
	200W On-Off	Max 10 mt	1811.B3	252,00	206,56	
	60W Dimmer	Max 3 mt	1811.B4*	205,00	168,03	
	120W Dimmer	Max 6 mt	1811.B5*	260,00	213,11	
	240W Dimmer	Max 10 mt	1811.B6*	310,00	254,10	
	Remote power supply Alimentatore remoto Entfernt liegendes Netzteil Fuente de alimentación colocada a distancia Удаленный блок питания	75W On-Off	Max 3.5 mt	1795.R1	54,00	44,26
		150W On-Off	Max 7.5 mt	1795.R2	73,00	59,84
		200W On-Off	Max 10 mt	1795.R3	165,00	135,25
		60W Dimmer	Max 3 mt	1795.R4*	113,00	92,62
		120W Dimmer	Max 6 mt	1795.R5*	168,00	137,70
		240W Dimmer	Max 12 mt	1795.R6*	218,00	178,69

* Dimmable with: 1 ~ 10Vdc, 10V PWM signal and resistance
Dimmerabile con: 1 ~ 10Vdc, 10V PWM segnale e resistenza
Dimmbar über: 1~10Vdc, 10V PWM-Signal und Widerstand
Intensidad luminosa regulable con: 1 ~ 10 Vcc, 10 V PWM señal y resistencia
Диммируется с помощью 1 ~ 10Vdc, 10V ШИМ-сигнала и резистора

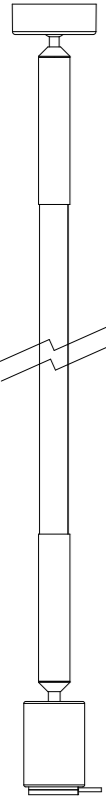

Vertical suspension

Sospensione verticale / Vertikale Aufhängung / Suspensión vertical / Вертикальное подвешивание

PRODUCT	FINISHES	°K	CODE	PAGE	PRICE € incl VAT (22%)	PRICE € excl VAT
 <p>3 m vertical suspension line (can be shortened to the desired measure) Linea sospensione verticale 3 m accorciabile a misura Kabel vertikale Aufhängung 3m nach Maß kürzbar Línea suspensión vertical 3 m, puede cortarse a medida Держатель для вертикального подвешивания длиной 3 м, укорачивается по индивидуальным размерам</p> <p>LINEA System</p>	Brushed aluminium Alluminio spazzolato Gebürstetes Aluminium Aluminio cepillado Крацованный алюминий	2700 °K	1795.S4.2700	189	856,00	701,64
		3000 °K	1795.S4.3000	189	856,00	701,64
	Black Nero Schwarz Negro Чёрный цвет	2700 °K	1810.S4.2700	189	942,00	772,13
		3000 °K	1810.S4.3000	189	942,00	772,13
	Sand Sabbia Sandfarben Arena Песочный цвет	2700 °K	1811.S4.2700	189	942,00	772,13
		3000 °K	1811.S4.3000	189	942,00	772,13





Horizontal suspension

Sospensione orizzontale / Horizontale Aufhängung / Suspensión horizontal / Горизонтальное подвешивание

PRODUCT	°K	CODE	PAGE	PRICE € incl VAT (22%)	PRICE € excl VAT
 <p>LINEA System</p> <p>Linear element Elemento lineare Lineares Element Elemento lineal Линейный элемент</p> <p>120 cm - 24W</p>	2700 °K	1795.S1.2700	197	473,00	387,70
	3000 °K	1795.S1.3000	197	473,00	387,70
 <p>LINEA System</p> <p>90° bend Curva 90° Kurve 90° Curva 90° Угловой элемент 90°</p> <p>11W</p>	2700 °K	1795.S2.2700	197	326,00	267,21
	3000 °K	1795.S2.3000	197	326,00	267,21
 <p>LINEA System</p> <p>180° bend Curva 180° Kurve 180° Curva 180° Угловой элемент 180°</p> <p>20W</p>	2700 °K	1795.S3.2700	197	423,00	346,72
	3000 °K	1795.S3.3000	197	423,00	346,72

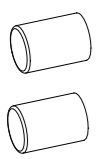
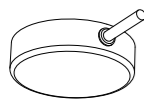
Horizontal suspension

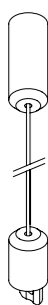
Accessories / Accessori / Zubehör / Accesorios / Аксессуары

ACCESSORIES	FINISHES	CODE	PRICE € incl VAT (22%)	PRICE € excl VAT
	Brushed aluminium Alluminio spazzolato Gebürstetes Aluminium Aluminio cepillado Крацованный алюминий	1795.M3	42,00	34,43
	Black Nero Schwarz Negro Чёрный цвет	1810.M3	42,00	34,43
	Sand Sabbia Sandfarben Arena Песочный цвет	1811.M3	42,00	34,43
	Brushed aluminium Alluminio spazzolato Gebürstetes Aluminium Aluminio cepillado Крацованный алюминий	1795.M4	77,00	63,11
	Black Nero Schwarz Negro Чёрный цвет	1810.M4	77,00	63,11
	Sand Sabbia Sandfarben Arena Песочный цвет	1811.M4	77,00	63,11
	Brushed aluminium Alluminio spazzolato Gebürstetes Aluminium Aluminio cepillado Крацованный алюминий	1795.M5	23,00	18,85
	Black Nero Schwarz Negro Чёрный цвет	1810.M5	23,00	18,85
	Sand Sabbia Sandfarben Arena Песочный цвет	1811.M5	23,00	18,85
	Brushed aluminium Alluminio spazzolato Gebürstetes Aluminium Aluminio cepillado Крацованный алюминий	1795.M6	61,00	50,00
	Black Nero Schwarz Negro Чёрный цвет	1810.M6	61,00	50,00
	Sand Sabbia Sandfarben Arena Песочный цвет	1811.M6	61,00	50,00
	Brushed aluminium Alluminio spazzolato Gebürstetes Aluminium Aluminio cepillado Крацованный алюминий	1795.M7	20,00	16,39
	Black Nero Schwarz Negro Чёрный цвет	1810.M7	20,00	16,39
	Sand Sabbia Sandfarben Arena Песочный цвет	1811.M7	20,00	16,39

* Up to 2 m, calculate 2 pcs + (1 x m) / over 3 m, calculate 1 pc + (1 x m) / Fino a 2 m calcolare 2 pcs + (1 x m) / oltre i 3 m calcolare 1 pc + (1 x m) / Bis zu 2 m 2 Stck. berechnen (1 pro m) / bei mehr als 3 m 1 Stck. + (1 pro m) berechnen / Hasta 2 m calcular 2 uds. + (1 x m) / Encima de 3 m calcular 1 ud. + (1 x m) / До 2 м нужно учитывать 2 шт. + (1 x м) / свыше 3 м нужно учитывать 1 шт. + (1 x м)

Horizontal suspension

Drivers and canopies / Driver e rosoni / Driver und Baldachin / Driver y Floròn / Драйверы и основания

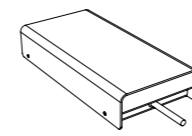
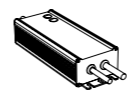
ACCESSORIES	FINISHES	W	Max MT	CODE	PRICE € incl VAT (22%)	PRICE € excl VAT
	Brushed aluminium Alluminio spazzolato Gebürstetes Aluminium Aluminio cepillado Крацованный алюминий	75W On-Off	Max 3.5 mt	1795.B1	140,00	114,75
		150W On-Off	Max 7.5 mt	1795.B2	159,00	130,33
		200W On-Off	Max 10 mt	1795.B3	252,00	206,56
		60W Dimmer	Max 3 mt	1795.B4*	205,00	168,03
		120W Dimmer	Max 6 mt	1795.B5*	260,00	213,11
		240W Dimmer	Max 10 mt	1795.B6*	310,00	254,10
	Black Nero Schwarz Negro Чёрный цвет	75W On-Off	Max 3.5 mt	1810.B1	140,00	114,75
		150W On-Off	Max 7.5 mt	1810.B2	159,00	130,33
		200W On-Off	Max 10 mt	1810.B3	252,00	206,56
		60W Dimmer	Max 3 mt	1810.B4*	205,00	168,03
		120W Dimmer	Max 6 mt	1810.B5*	260,00	213,11
		240W Dimmer	Max 10 mt	1810.B6*	310,00	254,10
Sand Sabbia Sandfarben Arena Песочный цвет	75W On-Off	Max 3.5 mt	1811.B1	140,00	114,75	
	150W On-Off	Max 7.5 mt	1811.B2	159,00	130,33	
	200W On-Off	Max 10 mt	1811.B3	252,00	206,56	
	60W Dimmer	Max 3 mt	1811.B4*	205,00	168,03	
	120W Dimmer	Max 6 mt	1811.B5*	260,00	213,11	
	240W Dimmer	Max 10 mt	1811.B6*	310,00	254,10	
	Remote power supply Alimentatore remoto Entfernt liegendes Netzteil Fuente de alimentación colocada a distancia Удаленный блок питания	75W On-Off	Max 3.5 mt	1795.R1	54,00	44,26
		150W On-Off	Max 7.5 mt	1795.R2	73,00	59,84
		200W On-Off	Max 10 mt	1795.R3	165,00	135,25
		60W Dimmer	Max 3 mt	1795.R4*	113,00	92,62
		120W Dimmer	Max 6 mt	1795.R5*	168,00	137,70
		240W Dimmer	Max 12 mt	1795.R6*	218,00	178,69

* Dimmable with: 1 ~ 10Vdc, 10V PWM signal and resistance
Dimmerabile con: 1 ~ 10Vdc, 10V PWM segnale e resistenza
Dimmbar über: 1~10Vdc, 10V PWM-Signal und Widerstand
Intensidad luminosa regulable con: 1 ~ 10 Vcc, 10 V PWM señal y resistencia
Диммируется с помощью 1 ~ 10Vdc, 10V ШИМ-сигнала и резистора

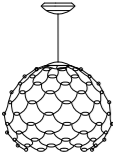
PRODUCT	FINISHES	°K	CODE	PAGE	PRICE € incl VAT (22%)	PRICE € excl VAT	
 <p>LAMO I Suspension Ø 40</p>	Gold Oro Gold Oro Золото	2700 °K	1812.30.2700	215	1.091,00	894,26	
			1812.30.2700.D*		1.191,00	976,23	
		3000 °K	1812.30.3000		1.091,00	894,26	
			1812.30.3000.D*		1.191,00	976,23	
	Plastic covers, Coperture plastica, Kunststoffabdeckungen, difusores en plástico, Пластиковые крышки				1812.30.KIT.COVER	208,00	170,49
	Copper Rame Kupfer Cobre Медь	2700 °K	1816.30.2700		215	1.091,00	894,26
			1816.30.2700.D*			1.191,00	976,23
		3000 °K	1816.30.3000			1.091,00	894,26
			1816.30.3000.D*	1.191,00		976,23	
	Plastic covers, Coperture plastica, Kunststoffabdeckungen, difusores en plástico, Пластиковые крышки			1816.30.KIT.COVER		208,00	170,49
	Chrome Cromo Chrom Cromo Хром	2700 °K	1817.30.2700	215		1.091,00	894,26
			1817.30.2700.D*			1.191,00	976,23
3000 °K		1817.30.3000	1.091,00			894,26	
		1817.30.3000.D*	1.191,00		976,23		
Plastic covers, Coperture plastica, Kunststoffabdeckungen, difusores en plástico, Пластиковые крышки			1817.30.KIT.COVER		208,00	170,49	

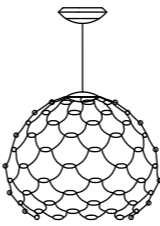
PRODUCT	FINISHES	°K	CODE	PAGE	PRICE € incl VAT (22%)	PRICE € excl VAT	
 <p>LAMO I Suspension Ø 80</p>	Gold Oro Gold Oro Золото	2700 °K	1812.32.2700	215	1.843,00	1.510,66	
			1812.32.2700.D*		1.943,00	1.592,62	
		3000 °K	1812.32.3000		1.843,00	1.510,66	
			1812.32.3000.D*		1.943,00	1.592,62	
	Plastic covers, Coperture plastica, Kunststoffabdeckungen, difusores en plástico, Пластиковые крышки				1812.32.KIT.COVER	421,00	345,08
	Copper Rame Kupfer Cobre Медь	2700 °K	1816.32.2700		215	1.843,00	1.510,66
			1816.32.2700.D*			1.943,00	1.592,62
		3000 °K	1816.32.3000			1.843,00	1.510,66
			1816.32.3000.D*	1.943,00		1.592,62	
	Plastic covers, Coperture plastica, Kunststoffabdeckungen, difusores en plástico, Пластиковые крышки			1816.32.KIT.COVER		421,00	345,08
	Chrome Cromo Chrom Cromo Хром	2700 °K	1817.32.2700	215		1.843,00	1.510,66
			1817.32.2700.D*			1.943,00	1.592,62
3000 °K		1817.32.3000	1.843,00			1.510,66	
		1817.32.3000.D*	1.943,00		1.592,62		
Plastic covers, Coperture plastica, Kunststoffabdeckungen, difusores en plástico, Пластиковые крышки			1817.32.KIT.COVER		421,00	345,08	

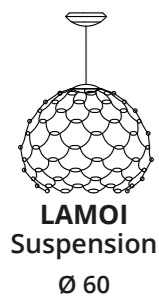

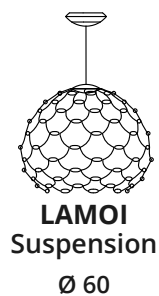

 <p>LAMO I Suspension Ø 60</p>	Gold Oro Gold Oro Золото	2700 °K	1812.31.2700	215	1.398,00	1.145,90	
			1812.31.2700.D*		1.498,00	1.227,87	
		3000 °K	1812.31.2700.DT**		1.498,00	1.227,87	
			1812.31.3000		1.398,00	1.145,90	
	3000 °K	1812.31.3000.D*	1.498,00		1.227,87		
		1812.31.3000.DT**	1.498,00		1.227,87		
	Plastic covers, Coperture plastica, Kunststoffabdeckungen, difusores en plástico, Пластиковые крышки				1812.31.KIT.COVER	305,00	250,00
	Copper Rame Kupfer Cobre Медь	2700 °K	1816.31.2700		215	1.398,00	1.145,90
			1816.31.2700.D*	1.498,00		1.227,87	
		3000 °K	1816.31.2700.DT**	1.498,00		1.227,87	
			1816.31.3000	1.398,00		1.145,90	
	3000 °K	1816.31.3000.D*	1.498,00	1.227,87			
1816.31.3000.DT**		1.498,00	1.227,87				
Plastic covers, Coperture plastica, Kunststoffabdeckungen, difusores en plástico, Пластиковые крышки			1816.31.KIT.COVER	305,00		250,00	
Chrome Cromo Chrom Cromo Хром	2700 °K	1817.31.2700	215	1.398,00		1.145,90	
		1817.31.2700.D*		1.498,00	1.227,87		
	3000 °K	1817.31.2700.DT**		1.498,00	1.227,87		
		1817.31.3000		1.398,00	1.145,90		
3000 °K	1817.31.3000.D*	1.498,00		1.227,87			
	1817.31.3000.DT**	1.498,00		1.227,87			

* Dimmable with: Push 0-10V/1-10V/Dali/ normally open button
 Dimmerabile con: Push 0-10v / 1-10v/Dali / pulsante normalmente aperto
 Dimmbar über: Push 0-10V / 1-10V/Dali / Taste normalerweise offen
 Intensidad luminosa regulable con: Push 0-10v / 1-10v/Dali / botón normalmente abierto
 Диммируется с помощью Push 0-10в / 1-10в/Dali / с нормально разомкнутой кнопкой

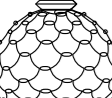
** Dimmable with: Triac
 Dimmerabile con: Triac
 Dimmbar über: Triac
 Intensidad luminosa regulable con: Triac
 Диммируется с помощью Triac

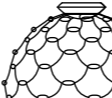
PRODUCT	FINISHES	°K	CODE	PAGE	PRICE € incl VAT (22%)	PRICE € excl VAT	
 LAMOI Ceiling Ø 40	Gold Oro Gold Oro Золото	2700 °K	1812.20.2700	227	1.061,00	869,67	
			1812.20.2700.D*		1.161,00	951,64	
		3000 °K	1812.20.3000		1.061,00	869,67	
			1812.20.3000.D*		1.161,00	951,64	
	Plastic covers, Coperture plastica, Kunststoffabdeckungen, difusores en plástico, Пластиковые крышки				1812.20.KIT.COVER	208,00	170,49
	Copper Rame Kupfer Cobre Медь	2700 °K	1816.20.2700		227	1.061,00	869,67
			1816.20.2700.D*			1.161,00	951,64
		3000 °K	1816.20.3000			1.061,00	869,67
			1816.20.3000.D*	1.161,00		951,64	
	Plastic covers, Coperture plastica, Kunststoffabdeckungen, difusores en plástico, Пластиковые крышки			1816.20.KIT.COVER		208,00	170,49
	Chrome Cromo Chrom Cromo Хром	2700 °K	1817.20.2700	227		1.061,00	869,67
			1817.20.2700.D*			1.161,00	951,64
3000 °K		1817.20.3000	1.061,00			869,67	
		1817.20.3000.D*	1.161,00		951,64		
Plastic covers, Coperture plastica, Kunststoffabdeckungen, difusores en plástico, Пластиковые крышки			1817.20.KIT.COVER		208,00	170,49	
 LAMOI Ceiling Ø 60	Gold Oro Gold Oro Золото	2700 °K	1812.21.2700		227	1.368,00	1.121,31
			1812.21.2700.D*			1.468,00	1.203,28
			1812.21.2700.DT**			1.468,00	1.203,28
		3000 °K	1812.21.3000	1.368,00		1.121,31	
	1812.21.3000.D*		1.468,00	1.203,28			
	Plastic covers, Coperture plastica, Kunststoffabdeckungen, difusores en plástico, Пластиковые крышки			1812.21.KIT.COVER		305,00	250,00
	Copper Rame Kupfer Cobre Медь	2700 °K	1816.21.2700	227		1.368,00	1.121,31
			1816.21.2700.D*			1.468,00	1.203,28
			1816.21.2700.DT**		1.468,00	1.203,28	
		3000 °K	1816.21.3000		1.368,00	1.121,31	
	1816.21.3000.D*		1.468,00		1.203,28		
	Plastic covers, Coperture plastica, Kunststoffabdeckungen, difusores en plástico, Пластиковые крышки				1816.21.KIT.COVER	305,00	250,00
Chrome Cromo Chrom Cromo Хром	2700 °K	1817.21.2700	227		1.368,00	1.121,31	
		1817.21.2700.D*			1.468,00	1.203,28	
		1817.21.2700.DT**		1.468,00	1.203,28		
	3000 °K	1817.21.3000		1.368,00	1.121,31		
1817.21.3000.D*		1.468,00		1.203,28			
Plastic covers, Coperture plastica, Kunststoffabdeckungen, difusores en plástico, Пластиковые крышки				1817.21.KIT.COVER	305,00	250,00	
Plastic covers, Coperture plastica, Kunststoffabdeckungen, difusores en plástico, Пластиковые крышки				1817.21.KIT.COVER	305,00	250,00	

PRODUCT	FINISHES	°K	CODE	PAGE	PRICE € incl VAT (22%)	PRICE € excl VAT	
 LAMOI Ceiling Ø 80	Gold Oro Gold Oro Золото	2700 °K	1812.22.2700	227	1.813,00	1.486,07	
			1812.22.2700.D*		1.913,00	1.568,03	
		3000 °K	1812.22.3000		1.813,00	1.486,07	
			1812.22.3000.D*		1.913,00	1.568,03	
	Plastic covers, Coperture plastica, Kunststoffabdeckungen, difusores en plástico, Пластиковые крышки				1812.22.KIT.COVER	420,00	344,26
	Copper Rame Kupfer Cobre Медь	2700 °K	1816.22.2700		227	1.813,00	1.486,07
			1816.22.2700.D*			1.913,00	1.568,03
		3000 °K	1816.22.3000			1.813,00	1.486,07
			1816.22.3000.D*	1.913,00		1.568,03	
	Plastic covers, Coperture plastica, Kunststoffabdeckungen, difusores en plástico, Пластиковые крышки			1816.22.KIT.COVER		420,00	344,26
	Chrome Cromo Chrom Cromo Хром	2700 °K	1817.22.2700	227		1.813,00	1.486,07
			1817.22.2700.D*			1.913,00	1.568,03
3000 °K		1817.22.3000	1.813,00			1.486,07	
		1817.22.3000.D*	1.913,00		1.568,03		
Plastic covers, Coperture plastica, Kunststoffabdeckungen, difusores en plástico, Пластиковые крышки			1817.22.KIT.COVER		420,00	344,26	
 LAMOI Floor Ø 40	Gold Oro Gold Oro Золото	2700 °K	1812.53.2700.D***		231	1.549,00	1.269,67
			1812.53.3000.D***			1.549,00	1.269,67
		3000 °K	1812.53.3000.D***			1.549,00	1.269,67
			1812.53.3000.D***	1.549,00		1.269,67	
	Plastic covers, Coperture plastica, Kunststoffabdeckungen, difusores en plástico, Пластиковые крышки			1812.53.KIT.COVER		208,00	170,49
	Copper Rame Kupfer Cobre Медь	2700 °K	1816.53.2700.D***	231		1.549,00	1.269,67
			1816.53.3000.D***			1.549,00	1.269,67
		3000 °K	1816.53.3000.D***			1.549,00	1.269,67
			1816.53.3000.D***		1.549,00	1.269,67	
	Plastic covers, Coperture plastica, Kunststoffabdeckungen, difusores en plástico, Пластиковые крышки				1816.53.KIT.COVER	208,00	170,49
	Chrome Cromo Chrom Cromo Хром	2700 °K	1817.53.2700.D***		231	1.549,00	1.269,67
			1817.53.3000.D***			1.549,00	1.269,67
3000 °K		1817.53.3000.D***	1.549,00			1.269,67	
		1817.53.3000.D***	1.549,00	1.269,67			
Plastic covers, Coperture plastica, Kunststoffabdeckungen, difusores en plástico, Пластиковые крышки			1817.53.KIT.COVER	208,00		170,49	

*** Footswitch dimmer included.
Dimmer a pedale incluso.
Inklusive Fußschalter und Dimmer.
Regulador de intensidad con pedal incluido.
В комплект входит диммер с ножным управлением.

* Dimmable with: Push 0-10V/1-10V/Dali/ normally open button
Dimmerabile con: Push 0-10v / 1-10v/Dali / pulsante normalmente aperto
Dimmbar über: Push 0-10V / 1-10V/Dali / Taste normalerweise offen
Intensidad luminosa regulable con: Push 0-10v / 1-10v/Dali / botón normalmente abierto
Диммируется с помощью Push 0-10v / 1-10v/Dali / с нормально разомкнутой кнопкой

** Dimmable with: Triac
Dimmerabile con: Triac
Dimmbar über: Triac
Intensidad luminosa regulable con: Triac
Диммируется с помощью Triac

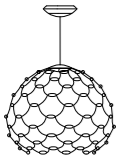
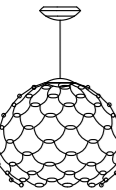
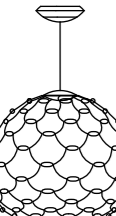
PRODUCT	FINISHES	°K	CODE	PAGE	PRICE € incl VAT (22%)	PRICE € excl VAT
 LAMO I Suspension Ø 40	Black Nero Schwarz Negro Чёрный цвет	2700 °K	1831.30.2700	215	1.091,00	894,26
			1831.30.2700.D*		1.191,00	976,23
		3000 °K	1831.30.3000		1.091,00	894,26
			1831.30.3000.D*		1.191,00	976,23
	Plastic covers, Coperture plastica, Kunststoffabdeckungen, difusores en plástico, Пластиковые крышки			1831.30.KIT.COVER	208,00	170,49
 LAMO I Suspension Ø 60	Black Nero Schwarz Negro Чёрный цвет	2700 °K	1831.31.2700	215	1.398,00	1.145,90
			1831.31.2700.D*		1.498,00	1.227,87
			1831.31.2700.DT**		1.498,00	1.227,87
		3000 °K	1831.31.3000		1.398,00	1.145,90
			1831.31.3000.D*		1.498,00	1.227,87
	1831.31.3000.DT**	1.498,00	1.227,87			
Plastic covers, Coperture plastica, Kunststoffabdeckungen, difusores en plástico, Пластиковые крышки			1831.31.KIT.COVER	305,00	250,00	
 LAMO I Suspension Ø 80	Black Nero Schwarz Negro Чёрный цвет	2700 °K	1831.32.2700	215	1.843,00	1.510,66
			1831.32.2700.D*		1.943,00	1.592,62
		3000 °K	1831.32.3000		1.843,00	1.510,66
			1831.32.3000.D*		1.943,00	1.592,62
	Plastic covers, Coperture plastica, Kunststoffabdeckungen, difusores en plástico, Пластиковые крышки			1831.32.KIT.COVER	421,00	345,08

* Dimmable with: Push 0-10V/1-10V/Dali/ normally open button
 Dimmerabile con: Push 0-10v / 1-10v/Dali / pulsante normalmente aperto
 Dimmbar über: Push 0-10V / 1-10V/Dali / Taste normalerweise offen
 Intensidad luminosa regulable con: Push 0-10v / 1-10v/Dali / botón normalmente abierto
 Диммируется с помощью Push 0-10в / 1-10в/Dali / с нормально разомкнутой кнопкой

PRODUCT	FINISHES	°K	CODE	PAGE	PRICE € incl VAT (22%)	PRICE € excl VAT
 LAMO I Ceiling Ø 40	Matt black Nero opaco Mattschwarz Negro mate Матовый черныйцвет	2700 °K	1831.20.2700	227	1.061,00	869,67
			1831.20.2700.D*		1.161,00	951,64
		3000 °K	1831.20.3000		1.061,00	869,67
			1831.20.3000.D*		1.161,00	951,64
	Plastic covers, Coperture plastica, Kunststoffabdeckungen, difusores en plástico, Пластиковые крышки			1831.20.KIT.COVER	208,00	170,49
 LAMO I Ceiling Ø 60	Matt black Nero opaco Mattschwarz Negro mate Матовый черныйцвет	2700 °K	1831.21.2700	227	1.368,00	1.121,31
			1831.21.2700.D*		1.468,00	1.203,28
			1831.21.2700.DT**		1.468,00	1.203,28
		3000 °K	1831.21.3000		1.368,00	1.121,31
			1831.21.3000.D*		1.468,00	1.203,28
	1831.21.3000.DT**	1.468,00	1.203,28			
Plastic covers, Coperture plastica, Kunststoffabdeckungen, difusores en plástico, Пластиковые крышки			1831.21.KIT.COVER	305,00	250,00	
 LAMO I Ceiling Ø 80	Matt black Nero opaco Mattschwarz Negro mate Матовый черныйцвет	2700 °K	1831.22.2700	227	1.813,00	1.486,07
			1831.22.2700.D*		1.913,00	1.568,03
		3000 °K	1831.22.3000		1.813,00	1.486,07
			1831.22.3000.D*		1.913,00	1.568,03
	Plastic covers, Coperture plastica, Kunststoffabdeckungen, difusores en plástico, Пластиковые крышки			1831.22.KIT.COVER	421,00	345,08

* Dimmable with: Push 0-10V/1-10V/Dali/ normally open button
 Dimmerabile con: Push 0-10v / 1-10v/Dali / pulsante normalmente aperto
 Dimmbar über: Push 0-10V / 1-10V/Dali / Taste normalerweise offen
 Intensidad luminosa regulable con: Push 0-10v / 1-10v/Dali / botón normalmente abierto
 Диммируется с помощью Push 0-10в / 1-10в/Dali / с нормально разомкнутой кнопкой

** Dimmable with: Triac
 Dimmerabile con: Triac
 Dimmbar über: Triac
 Intensidad luminosa regulable con: Triac
 Диммируется с помощью Triac

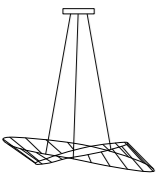
PRODUCT	FINISHES	°K	CODE	PAGE	PRICE € incl VAT (22%)	PRICE € excl VAT
 <p>TESA Suspension 72x65</p>	Matt powder pink <i>Cipria opaco Puderfarben matt Rosa palo mate Пудровый матовый</i>	2700 °K	1837.31.2700	241	605,00	495,90
			1837.31.2700.D*		715,00	586,07
		3000 °K	1837.31.3000		605,00	495,90
			1837.31.3000.D*		715,00	586,07
	Matt copper <i>Rame opaco Kupferfarben matt Cobre mate Медный матовый</i>	2700 °K	1836.31.2700	241	605,00	495,90
			1836.31.2700.D*		715,00	586,07
		3000 °K	1836.31.3000		605,00	495,90
			1836.31.3000.D*		715,00	586,07

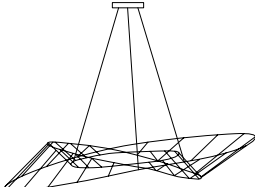
 <p>TESA Suspension 120x81</p>	Matt powder pink <i>Cipria opaco Puderfarben matt Rosa palo mate Пудровый матовый</i>	2700 °K	1837.30.2700	241	825,00	676,23
			1837.30.2700.D*		935,00	766,39
		3000 °K	1837.30.3000		825,00	676,23
			1837.30.3000.D*		935,00	766,39
	Matt copper <i>Rame opaco Kupferfarben matt Cobre mate Медный матовый</i>	2700 °K	1836.30.2700	241	825,00	676,23
			1836.30.2700.D*		935,00	766,39
		3000 °K	1836.30.3000		825,00	676,23
			1836.30.3000.D*		935,00	766,39

* Dimmable with: Push 0-10V/1-10V/Dali/ normally open button
 Dimmerabile con: Push 0-10v / 1-10v/Dali / pulsante normalmente aperto
 Dimmbar über: Push 0-10V / 1-10V/Dali / Taste normalerweise offen
 Intensidad luminosa regulable con: Push 0-10v / 1-10v/Dali / botón normalmente abierto
 Диммируется с помощью Push 0-10в / 1-10в/Dali / с нормально разомкнутой кнопкой.

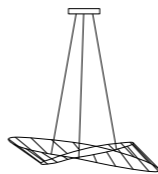
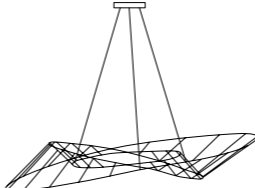
PRODUCT	FINISHES	°K	CODE	PAGE	PRICE € incl VAT (22%)	PRICE € excl VAT			
 <p>TESA 2.0 Suspension 72x65</p>	Matt black <i>Nero opaco Mattschwarz Negro mate Матовый черный/ее</i>	2700 °K	1838.31.2700	263	605,00	495,90			
			1838.31.2700.D*		715,00	586,07			
			3000 °K		1838.31.3000	605,00	495,90		
					1838.31.3000.D*	715,00	586,07		
		 <p>TESA 2.0 Suspension 120x81</p>	Matt black <i>Nero opaco Mattschwarz Negro mate Матовый черный/ее</i>	2700 °K	1838.30.2700	263	825,00	676,23	
					1838.30.2700.D*		935,00	766,39	
					3000 °K		1838.30.3000	825,00	676,23
							1838.30.3000.D*	935,00	766,39

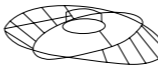
 <p>TESA 2.0 Ceiling</p>	Matt black <i>Nero opaco Mattschwarz Negro mate Матовый черный/ее</i>	2700 °K	1838.21.2700	269	605,00	495,90	
			1838.21.2700.D*		715,00	586,07	
			3000 °K		1838.21.3000	605,00	495,90
					1838.21.3000.D*	715,00	586,07

* Dimmable with: Push 0-10V/1-10V/Dali/ normally open button
 Dimmerabile con: Push 0-10v / 1-10v/Dali / pulsante normalmente aperto
 Dimmbar über: Push 0-10V / 1-10V/Dali / Taste normalerweise offen
 Intensidad luminosa regulable con: Push 0-10v / 1-10v/Dali / botón normalmente abierto
 Диммируется с помощью Push 0-10в / 1-10в/Dali / с нормально разомкнутой кнопкой.

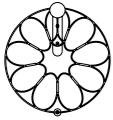
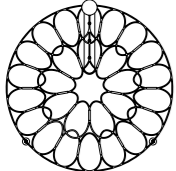
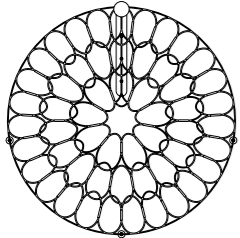
PRODUCT	FINISHES	°K	CODE	PAGE	PRICE € incl VAT (22%)	PRICE € excl VAT
 LAFRA Ceiling Ø 45	Chrome Cromo Chrom Cromo Хром	2700 °K	1833.21.2700	283	394,00	322,95
			1833.21.2700.DP*		429,00	351,64
		3000 °K	1833.21.3000		394,00	322,95
			1833.21.3000.DP*		429,00	351,64
	Plastic covers, Coperture plastica, Kunststoffabdeckungen, difusores en plástico, Пластиковые крышки			1833.21.KIT.COVER	36,00	29,51
 LAFRA Ceiling Ø 70	Chrome Cromo Chrom Cromo Хром	2700 °K	1833.22.2700	283	667,00	546,72
			1833.22.2700.DP*		706,00	578,69
		3000 °K	1833.22.3000		667,00	546,72
			1833.22.3000.DP*		706,00	578,69
	Plastic covers, Coperture plastica, Kunststoffabdeckungen, difusores en plástico, Пластиковые крышки			1833.22.KIT.COVER	105,00	86,07
 LAFRA Ceiling Ø 95	Chrome Cromo Chrom Cromo Хром	2700 °K	1833.23.2700	283	1.011,00	828,69
			1833.23.2700.DP*		1.046,00	857,38
		3000 °K	1833.23.3000		1.011,00	828,69
			1833.23.3000.DP*		1.046,00	857,38
	Plastic covers, Coperture plastica, Kunststoffabdeckungen, difusores en plástico, Пластиковые крышки			1833.23.KIT.COVER	208,00	170,49

* Dimmable with Push
 Dimmerabile con Push
 Dimmbar über Push
 Intensidad luminosa regulable con Push
 Диммируется с помощью Push

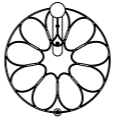
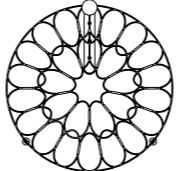
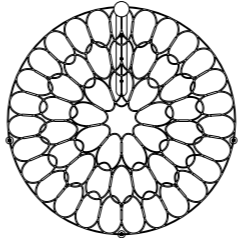
PRODUCT	FINISHES	°K	CODE	PAGE	PRICE € incl VAT (22%)	PRICE € excl VAT
 LAFRA Wall Ø 45	Chrome Cromo Chrom Cromo Хром	2700 °K	1833.11.2700	293	388,00	318,03
			1833.11.2700.DP*		417,00	341,80
		3000 °K	1833.11.3000		388,00	318,03
			1833.11.3000.DP*		417,00	341,80
	Plastic covers, Coperture plastica, Kunststoffabdeckungen, difusores en plástico, Пластиковые крышки			1833.11.KIT.COVER	36,00	29,51
 LAFRA Wall Ø 70	Chrome Cromo Chrom Cromo Хром	2700 °K	1833.12.2700	293	655,00	536,89
			1833.12.2700.DP*		694,00	568,85
		3000 °K	1833.12.3000		655,00	536,89
			1833.12.3000.DP*		694,00	568,85
	Plastic covers, Coperture plastica, Kunststoffabdeckungen, difusores en plástico, Пластиковые крышки			1833.12.KIT.COVER	105,00	86,07
 LAFRA Wall Ø 95	Chrome Cromo Chrom Cromo Хром	2700 °K	1833.13.2700	293	999,00	818,85
			1833.13.2700.DP*		1.034,00	847,54
		3000 °K	1833.13.3000		999,00	818,85
			1833.13.3000.DP*		1.034,00	847,54
	Plastic covers, Coperture plastica, Kunststoffabdeckungen, difusores en plástico, Пластиковые крышки			1833.13.KIT.COVER	208,00	170,49

* Dimmable with Push
 Dimmerabile con Push
 Dimmbar über Push
 Intensidad luminosa regulable con Push
 Диммируется с помощью Push

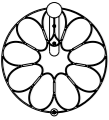
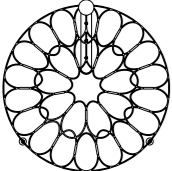
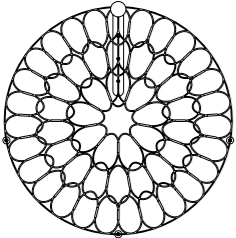
PRODUCT	FINISHES	°K	CODE	PAGE	PRICE € incl VAT (22%)	PRICE € excl VAT
 <p>LAFRA Ceiling Ø 45</p>	Matt black Nero opaco Mattschwarz Negro mate Матовый черныйеве	2700 °K	1834.21.2700	283	394,00	322,95
			1834.21.2700.DP*		429,00	351,64
		3000 °K	1834.21.3000		394,00	322,95
			1834.21.3000.DP*		429,00	351,64
	Plastic covers, Coperture plastica, Kunststoffabdeckungen, difusores en plástico, Пластиковые крышки	1834.21.KIT.COVER	36,00	29,51		
 <p>LAFRA Ceiling Ø 70</p>	Matt black Nero opaco Mattschwarz Negro mate Матовый черныйеве	2700 °K	1834.22.2700	283	667,00	546,72
			1834.22.2700.DP*		706,00	578,69
		3000 °K	1834.22.3000		667,00	546,72
			1834.22.3000.DP*		706,00	578,69
	Plastic covers, Coperture plastica, Kunststoffabdeckungen, difusores en plástico, Пластиковые крышки	1834.22.KIT.COVER	105,00	86,07		
 <p>LAFRA Ceiling Ø 95</p>	Matt black Nero opaco Mattschwarz Negro mate Матовый черныйеве	2700 °K	1834.23.2700	283	1.011,00	828,69
			1834.23.2700.DP*		1.046,00	857,38
		3000 °K	1834.23.3000		1.011,00	828,69
			1834.23.3000.DP*		1.046,00	857,38
	Plastic covers, Coperture plastica, Kunststoffabdeckungen, difusores en plástico, Пластиковые крышки	1834.23.KIT.COVER	208,00	170,49		

* Dimmable with Push
 Dimmerabile con Push
 Dimmbar über Push
 Intensidad luminosa regulable con Push
 Диммируется с помощью Push

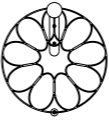
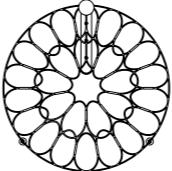
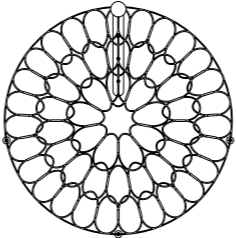
PRODUCT	FINISHES	°K	CODE	PAGE	PRICE € incl VAT (22%)	PRICE € excl VAT
 <p>LAFRA Wall Ø 45</p>	Matt black Nero opaco Mattschwarz Negro mate Матовый черныйеве	2700 °K	1834.11.2700	293	388,00	318,03
			1834.11.2700.DP*		417,00	341,80
		3000 °K	1834.11.3000		388,00	318,03
			1834.11.3000.DP*		417,00	341,80
	Plastic covers, Coperture plastica, Kunststoffabdeckungen, difusores en plástico, Пластиковые крышки	1834.11.KIT.COVER	36,00	29,51		
 <p>LAFRA Wall Ø 70</p>	Matt black Nero opaco Mattschwarz Negro mate Матовый черныйеве	2700 °K	1834.12.2700	293	655,00	536,89
			1834.12.2700.DP*		694,00	568,85
		3000 °K	1834.12.3000		655,00	536,89
			1834.12.3000.DP*		694,00	568,85
	Plastic covers, Coperture plastica, Kunststoffabdeckungen, difusores en plástico, Пластиковые крышки	1834.12.KIT.COVER	105,00	86,07		
 <p>LAFRA Wall Ø 95</p>	Matt black Nero opaco Mattschwarz Negro mate Матовый черныйеве	2700 °K	1834.13.2700	293	999,00	818,85
			1834.13.2700.DP*		1.034,00	847,54
		3000 °K	1834.13.3000		999,00	818,85
			1834.13.3000.DP*		1.034,00	847,54
	Plastic covers, Coperture plastica, Kunststoffabdeckungen, difusores en plástico, Пластиковые крышки	1834.13.KIT.COVER	208,00	170,49		

* Dimmable with Push
 Dimmerabile con Push
 Dimmbar über Push
 Intensidad luminosa regulable con Push
 Диммируется с помощью Push

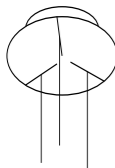
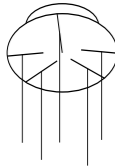
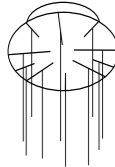
PRODUCT	FINISHES	CODE	PAGE	PRICE incl VAT (22%)	PRICE excl VAT
 <p>BEBA Ceiling canopy</p>	<p>One-light ceiling canopy <i>Montatura 1 luce</i> <i>Gestell 1 Licht</i> <i>Florón 1 luz</i> Рамка с 1 светоэлементом</p>	1730.M.30	313	74,00	60,66
 <p>BEBA Ceiling canopy</p>	<p>Three-lights round ceiling canopy <i>Montatura tonda 3 luci Kit</i> <i>Rundes Gestell 3 Lichter Set</i> <i>Florón redondo 3 luces</i> Круглая рамка с 3 светоэлементами Комплект</p>	1730.M.34	313	270,00	221,31
 <p>BEBA Ceiling canopy</p>	<p>Five-lights round ceiling canopy <i>Montatura tonda 5 luci Kit</i> <i>Rundes Gestell 5 Lichter Set</i> <i>Florón redondo 5 luces</i> Круглая рамка с 5 светоэлементами Комплект</p>	1730.M.35	313	420,00	344,26
 <p>BEBA Ceiling canopy</p>	<p>Ten-lights round ceiling canopy <i>Montatura tonda 10 luci Kit</i> <i>Rundes Gestell 10 Lichter Set</i> <i>Florón redondo 10 luces</i> Круглая рамка с 10 светоэлементами Комплект</p>	1730.M.36	313	894,00	732,79

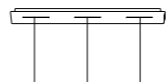
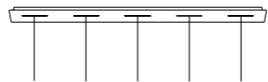
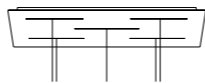
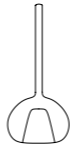
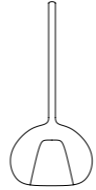
PRODUCT	FINISHES	CODE	PAGE	PRICE € incl VAT (22%)	PRICE € excl VAT
	<p>Three-lights linear ceiling canopy with cables and lamp holder <i>Montatura lineare 3 luci con cavi e portalampada</i> <i>Lineares Gestell 3 Lichter mit Kabeln und Fassung</i> <i>Montaje lineal 3 luces con cables y portalámparas</i> Линейная рамка с 3 светоэлементами с кабелями и держателем лампы Комплект</p>	1730.M.40	313	210,00	172,13
	<p>Five-lights linear ceiling canopy with cables and lamp holder <i>Montatura lineare 5 luci con cavi e portalampada</i> <i>Lineares Gestell 5 Lichter mit Kabeln und Fassung</i> <i>Montaje lineal 5 luces con cables y portalámparas</i> Линейная рамка с 5 светоэлементами с кабелями и держателем лампы Комплект</p>	1730.M.41	313	327,00	268,03
	<p>Five-lights rectangular ceiling canopy with cables and lamp holder <i>Montatura rettangolare 5 luci con cavi e portalampada</i> <i>Rechteckiges Gestell 5 Lichter mit Kabeln und Fassung</i> <i>Montaje rectangular 5 luces con cables y portalámparas</i> Прямоугольная рамка с 5 светоэлементами с кабелями и держателем лампы Комплект</p>	1730.M.42	313	423,00	346,72
 <p>BEBA Glass 15 x 35</p>	<p>Trasparent <i>Trasparente</i> Transparent <i>Transparente</i> Прозрачный</p>	1730.V.TR	313	74,00	60,66
	<p>Chrome <i>Cromo</i> Chrom <i>Cromo</i> Хром</p>	1730.V.CR		108,00	88,52
	<p>Bronze <i>Bronzo</i> Bronze <i>Bronze</i> бронза</p>	1730.V.BZ		108,00	88,52
	<p>Gold <i>Oro</i> Gold <i>Oro</i> Золото</p>	1730.V.GOLD		108,00	88,52
 <p>BEBA Glass 20 x 45</p>	<p>Trasparent <i>Trasparente</i> Transparent <i>Transparente</i> Прозрачный</p>	1730.V.BIG.TR	313	155,00	127,05
	<p>Chrome <i>Cromo</i> Chrom <i>Cromo</i> Хром</p>	1730.V.BIG.CR		161,00	131,97
	<p>Bronze <i>Bronzo</i> Bronze <i>Bronze</i> бронза</p>	1730.V.BIG.BZ		161,00	131,97
	<p>Gold <i>Oro</i> Gold <i>Oro</i> Золото</p>	1730.V.BIG.GOLD		161,00	131,97



U14

urbanlighting.it

Headquarter / Showroom
Viale Dell'Industria, 21
20037 Paderno Dugnano (MI) Italia
T. +39 02 9104958
T. +39 02 9105178
info@sforzinilluminazione.com