

URBAN
L I G H T I N G

PRICE LIST

LISTINO PREZZI

PREISLISTE

LISTA DE PRECIOS

ПРАЙС-ЛИСТ

Catalogo 13
+ Serie Anello + Olo e Aki Special Edition

Index

LINEA
PRICE LIST 4-15

AKI
PRICE LIST 16-17

AKI
Special Edition
PRICE LIST 18

OLO
PRICE LIST 19

OLO
Special Edition
PRICE LIST 20

ANELLO
PRICE LIST 21-25

LAMOI
PRICE LIST 26-29

TESA MINI
PRICE LIST 30

TESA
PRICE LIST 30

LAFRA
PRICE LIST 31-39

CAOS CONTRACT
PRICE LIST 40

CAOS
PRICE LIST 41-42

AREA
PRICE LIST 43

HONEY BLACK
PRICE LIST 44-45

BEBA
PRICE LIST 46-47

Wall-wall mounting, "Tesata" installation

Montaggio Parete/Parete, installazione "Tesata" / Wand/Wand Montage, Installationsmethode "Tesata" /
Montaje en Pared/Pared, instalación "Tesata" / Монтаж от стены до стены, установка с натяжкой

MODEL	PRODUCT
Remote power supply / Alimentatore remoto / Entfernt liegendes Netzteil / Fuente de alimentación remota / Источник дистанционного питания	
A	
B	
C	
On-device power supply / Alimentatore a bordo / Integriertes Netzteil / Con fuente de alimentación / Встроенный блок питания	
D	
E	

Wall-wall

Luminaire / Corpo illuminante / Beleuchtungskörper / Cuerpo iluminador / Светильник

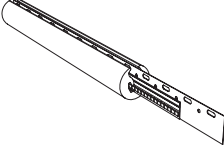
PRODUCT	FINISHES	MT.	°K	CODE	PRICE € incl VAT (22%)	PRICE € excl VAT	
 LINEA System	Complete LED line, steel, silicone Linea completa Led, Acciaio, Silicone Linea, komplett mit LED, Stahl & Silikon Linea completa led, acero, silicona Комплексная линия, включающая светодиоды, сталь, силикон	1	2700 °K	1795.L1.2700	234,00	191,80	
		2	2700 °K	1795.L2.2700	387,00	317,21	
		3	2700 °K	1795.L3.2700	539,00	441,80	
		4	2700 °K	1795.L4.2700	710,00	581,97	
		5	2700 °K	1795.L5.2700	862,00	706,56	
		6	2700 °K	1795.L6.2700	1.015,00	831,97	
		7	2700 °K	1795.L7.2700	1.187,00	972,95	
		8	2700 °K	1795.L8.2700	1.339,00	1.097,54	
		9	2700 °K	1795.L9.2700	1.491,00	1.222,13	
		10	2700 °K	1795.L10.2700	1.644,00	1.347,54	
			1	3000 °K	1795.L1.3000	234,00	191,80
			2	3000 °K	1795.L2.3000	387,00	317,21
			3	3000 °K	1795.L3.3000	539,00	441,80
			4	3000 °K	1795.L4.3000	710,00	581,97
			5	3000 °K	1795.L5.3000	862,00	706,56
			6	3000 °K	1795.L6.3000	1.015,00	831,97
			7	3000 °K	1795.L7.3000	1.187,00	972,95
			8	3000 °K	1795.L8.3000	1.339,00	1.097,54
			9	3000 °K	1795.L9.3000	1.491,00	1.222,13
			10	3000 °K	1795.L10.3000	1.644,00	1.347,54

Wall-wall

Accessories / Accessori / Zubehör / Accesorios / Аксессуары

ACCESSORIES	FINISHES	CODE	PRICE € incl VAT (22%)	PRICE € excl VAT
	Brushed aluminium Alluminio spazzolato Gebürstetes Aluminium Aluminio cepillado Крацованный алюминий	1795.M1	382,00	313,11
	Black Nero Schwarz Negro Чёрный цвет	1810.M1	382,00	313,11
	Sand Sabbia Sandfarben Arena Песочный цвет	1811.M1	382,00	313,11
	Brushed aluminium Alluminio spazzolato Gebürstetes Aluminium Aluminio cepillado Крацованный алюминий	1795.M4	77,00	63,11
	Black Nero Schwarz Negro Чёрный цвет	1810.M4	77,00	63,11
	Sand Sabbia Sandfarben Arena Песочный цвет	1811.M4	77,00	63,11
	Brushed aluminium Alluminio spazzolato Gebürstetes Aluminium Aluminio cepillado Крацованный алюминий	1795.M5	23,00	18,85
	Black Nero Schwarz Negro Чёрный цвет	1810.M5	23,00	18,85
	Sand Sabbia Sandfarben Arena Песочный цвет	1811.M5	23,00	18,85

* Up to 2 m, calculate 2 pcs + (1 x m) / over 3 m, calculate 1 pc + (1 x m) / Fino a 2 m calcolare 2 pcs + (1 x m) / oltre i 3 m calcolare 1 pc + (1 x m) / Bis zu 2 m 2 Stck. berechnen (1 pro m) / bei mehr als 3 m 1 Stck. + (1 pro m) berechnen / Hasta 2 m calcular 2 uds. + (1 x m) / Encima de 3 m calcular 1 ud. + (1 x m) / До 2 м нужно учитывать 2 шт. + (1 x м) / свыше 3 м нужно учитывать 1 шт. + (1 x м)

Wall-wall

Drivers and canopies / Driver e rosoni / Driver und Baldachin / Driver y Floròn / Драйверы и основания

ACCESSORIES	FINISHES	W	Max MT	CODE	PRICE € incl VAT (22%)	PRICE € excl VAT
	Brushed aluminium Alluminio spazzolato Gebürstetes Aluminium Aluminio cepillado Крацованный алюминий	75W ON-OFF	Max 3.5 mt	1795.B1	140,00	114,75
		150W ON-OFF	Max 7.5 mt	1795.B2	159,00	130,33
		200W ON-OFF	Max 10 mt	1795.B3	252,00	206,56
		60W Dimmer	Max 3 mt	1795.B4*	205,00	168,03
		120W Dimmer	Max 6 mt	1795.B5*	260,00	213,11
		240W Dimmer	Max 10 mt	1795.B6*	310,00	254,10
	Black Nero Schwarz Negro Чёрный цвет	75W ON-OFF	Max 3.5 mt	1810.B1	140,00	114,75
		150W ON-OFF	Max 7.5 mt	1810.B2	159,00	130,33
		200W ON-OFF	Max 10 mt	1810.B3	252,00	206,56
		60W Dimmer	Max 3 mt	1810.B4*	205,00	168,03
		120W Dimmer	Max 6 mt	1810.B5*	260,00	213,11
		240W Dimmer	Max 10 mt	1810.B6*	310,00	254,10
	Sand Sabbia Sandfarben Arena Песочный цвет	75W ON-OFF	Max 3.5 mt	1811.B1	140,00	114,75
		150W ON-OFF	Max 7.5 mt	1811.B2	159,00	130,33
		200W ON-OFF	Max 10 mt	1811.B3	252,00	206,56
		60W Dimmer	Max 3 mt	1811.B4*	205,00	168,03
		120W Dimmer	Max 6 mt	1811.B5*	260,00	213,11
		240W Dimmer	Max 10 mt	1811.B6*	310,00	254,10
	Remote power supply Alimentatore remoto Entfernt liegendes Netzteil Fuente de alimentación colocada a distancia Удаленный блок питания	75W ON-OFF	Max 3.5 mt	1795.R1	54,00	44,26
		150W ON-OFF	Max 7.5 mt	1795.R2	73,00	59,84
		200W ON-OFF	Max 10 mt	1795.R3	165,00	135,25
		60W Dimmer	Max 3 mt	1795.R4*	113,00	92,62
		120W Dimmer	Max 6 mt	1795.R5*	168,00 €	137,70
		240W Dimmer	Max 12 mt	1795.R6*	218,00	178,69

* Dimmable with: 1 ~ 10Vdc, 10V PWM signal and resistance
Dimmerabile con: 1 ~ 10Vdc, 10V PWM segnale e resistenza
Dimmbar über: 1~10Vdc, 10V PWM-Signal und Widerstand
Intensidad luminosa regulable con: 1 ~ 10 Vcc, 10 V PWM señal y resistencia
Диммируется с помощью 1 ~ 10Vdc, 10V ШИМ-сигнала и резистора

Surface mounting, "Wall-ceiling" installation

Montaggio Superficiale, installazione "Parete-Soffitto" / Aufputzmontage, Installation Wand-Decke /
Montaje en superficie, instalación Pared-Techo / Монтаж на поверхность, установка со стены до потолка

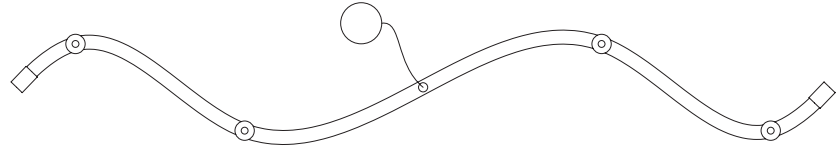
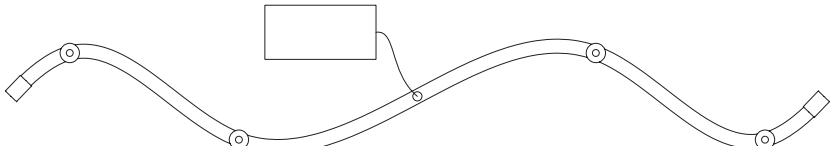
MODEL	PRODUCT
A	
B	

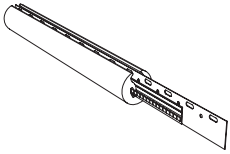

Surface mounting

Luminaire / Corpo illuminante / Beleuchtungskörper / Cuerpo iluminador / Светильник

PRODUCT	FINISHES	MT.	°K	CODE	PRICE € incl VAT (22%)	PRICE € excl VAT
 LINEA System	Complete LED line, steel, silicone <i>Linea completa Led, Acciaio, Silicone</i> <i>Linea, komplett mit LED, Stahl & Silikon</i> <i>Linea completa led, acero, silicona</i> <i>Комплексная линия, включающая светодиоды, сталь, силикон</i>	1	2700 °K	1795.L1.2700	234,00	191,80
		2	2700 °K	1795.L2.2700	387,00	317,21
		3	2700 °K	1795.L3.2700	539,00	441,80
		4	2700 °K	1795.L4.2700	710,00	581,97
		5	2700 °K	1795.L5.2700	862,00	706,56
		6	2700 °K	1795.L6.2700	1.015,00	831,97
		7	2700 °K	1795.L7.2700	1.187,00	972,95
		8	2700 °K	1795.L8.2700	1.339,00	1.097,54
		9	2700 °K	1795.L9.2700	1.491,00	1.222,13
		10	2700 °K	1795.L10.2700	1.644,00	1.347,54
		1	3000 °K	1795.L1.3000	234,00	191,80
		2	3000 °K	1795.L2.3000	387,00	317,21
		3	3000 °K	1795.L3.3000	539,00	441,80
		4	3000 °K	1795.L4.3000	710,00	581,97
		5	3000 °K	1795.L5.3000	862,00	706,56
		6	3000 °K	1795.L6.3000	1.015,00	831,97
		7	3000 °K	1795.L7.3000	1.187,00	972,95
		8	3000 °K	1795.L8.3000	1.339,00	1.097,54
		9	3000 °K	1795.L9.3000	1.491,00	1.222,13
		10	3000 °K	1795.L10.3000	1.644,00	1.347,54

Surface mounting

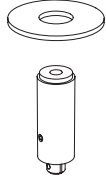
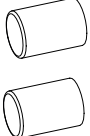
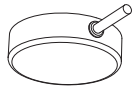
Accessories / Accessori / Zubehör / Accesorios / Аксессуары

ACCESSORIES	FINISHES	CODE	PRICE € incl VAT (22%)	PRICE € excl VAT
	Brushed aluminium Alluminio spazzolato Gebürstetes Aluminium Aluminio cepillado Крацованный алюминий	1795.M2	33,00	27,05
	Black Nero Schwarz Negro Чёрный цвет	1810.M2	33,00	27,05
	Sand Sabbia Sandfarben Arena Песочный цвет	1811.M2	33,00	27,05
	Brushed aluminium Alluminio spazzolato Gebürstetes Aluminium Aluminio cepillado Крацованный алюминий	1795.M3	42,00	34,43
	Black Nero Schwarz Negro Чёрный цвет	1810.M3	42,00	34,43
	Sand Sabbia Sandfarben Arena Песочный цвет	1811.M3	42,00	34,43
	Brushed aluminium Alluminio spazzolato Gebürstetes Aluminium Aluminio cepillado Крацованный алюминий	1795.M4	77,00	63,11
	Black Nero Schwarz Negro Чёрный цвет	1810.M4	77,00	63,11
	Sand Sabbia Sandfarben Arena Песочный цвет	1811.M4	77,00	63,11
	Brushed aluminium Alluminio spazzolato Gebürstetes Aluminium Aluminio cepillado Крацованный алюминий	1795.M5	23,00	18,85
	Black Nero Schwarz Negro Чёрный цвет	1810.M5	23,00	18,85
	Sand Sabbia Sandfarben Arena Песочный цвет	1811.M5	23,00	18,85

* Up to 2 m, calculate 2 pcs + (1 x m) / over 3 m, calculate 1 pc + (1 x m) / Fino a 2 m calcolare 2 pcs + (1 x m) / oltre i 3 m calcolare 1 pc + (1 x m) / Bis zu 2 m 2 Stck. berechnen (1 pro m) / bei mehr als 3 m 1 Stck. + (1 pro m) berechnen / Hasta 2 m calcular 2 uds. + (1 x m) / Encima de 3 m calcular 1 ud. + (1 x m) / До 2 м нужно учитывать 2 шт. + (1 x м) / свыше 3 м нужно учитывать 1 шт. + (1 x м)

Surface mounting

Drivers and canopies / Driver e rosoni / Driver und Baldachin / Driver y Floròn / Драйверы и основания

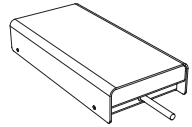
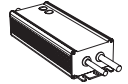
ACCESSORIES	FINISHES	W	Max MT	CODE	PRICE € incl VAT (22%)	PRICE € excl VAT
	Brushed aluminium Alluminio spazzolato Gebürstetes Aluminium Aluminio cepillado Крацованный алюминий	75W ON-OFF	Max 3.5 mt	1795.B1	140,00	114,75
		150W ON-OFF	Max 7.5 mt	1795.B2	159,00	130,33
		200W ON-OFF	Max 10 mt	1795.B3	252,00	206,56
		60W Dimmer	Max 3 mt	1795.B4*	205,00	168,03
		120W Dimmer	Max 6 mt	1795.B5*	260,00	213,11
		240W Dimmer	Max 10 mt	1795.B6*	310,00	254,10
	Black Nero Schwarz Negro Чёрный цвет	75W ON-OFF	Max 3.5 mt	1810.B1	140,00	114,75
		150W ON-OFF	Max 7.5 mt	1810.B2	159,00	130,33
		200W ON-OFF	Max 10 mt	1810.B3	252,00	206,56
		60W Dimmer	Max 3 mt	1810.B4*	205,00	168,03
		120W Dimmer	Max 6 mt	1810.B5*	260,00	213,11
		240W Dimmer	Max 10 mt	1810.B6*	310,00	254,10
Sand Sabbia Sandfarben Arena Песочный цвет	75W ON-OFF	Max 3.5 mt	1811.B1	140,00	114,75	
	150W ON-OFF	Max 7.5 mt	1811.B2	159,00	130,33	
	200W ON-OFF	Max 10 mt	1811.B3	252,00	206,56	
	60W Dimmer	Max 3 mt	1811.B4*	205,00	168,03	
	120W Dimmer	Max 6 mt	1811.B5*	260,00	213,11	
	240W Dimmer	Max 10 mt	1811.B6*	310,00	254,10	
	Remote power supply Alimentatore remoto Entfernt liegendes Netzteil Fuente de alimentación colocada a distancia Удаленный блок питания	75W ON-OFF	Max 3.5 mt	1795.R1	54,00	44,26
		150W ON-OFF	Max 7.5 mt	1795.R2	73,00	59,84
		200W ON-OFF	Max 10 mt	1795.R3	165,00	135,25
		60W Dimmer	Max 3 mt	1795.R4*	113,00	92,62 €
		120W Dimmer	Max 6 mt	1795.R5*	168,00	137,70
		240W Dimmer	Max 12 mt	1795.R6*	218,00	178,69

* Dimmable with: 1 ~ 10Vdc, 10V PWM signal and resistance
Dimmerabile con: 1 ~ 10Vdc, 10V PWM segnale e resistenza
Dimmbar über: 1~10Vdc, 10V PWM-Signal und Widerstand
Intensidad luminosa regulable con: 1 ~ 10 Vcc, 10 V PWM señal y resistencia
Диммируется с помощью 1 ~ 10Vdc, 10V ШИМ-сигнала и резистора

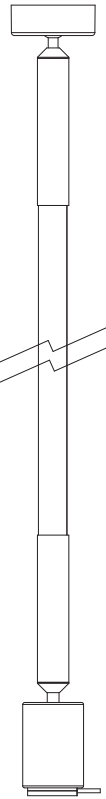

Vertical suspension

Sospensione verticale / Vertikale Aufhängung / Suspensión vertical / Вертикальное подвешивание

PRODUCT		FINISHES	°K	CODE	PRICE € incl VAT (22%)	PRICE € excl VAT
 <p>LINEA System</p>	<p>3 m vertical suspension line (can be shortened to the desired measure) <i>Linea sospensione verticale 3 m accorciabile a misura</i> <i>Kabel vertikale Aufhängung 3m nach Maß kürzbar</i> <i>Linea suspensión vertical 3 m, puede cortarse a medida</i> <i>Держатель для вертикального подвешивания длиной 3 м, укорачивается по индивидуальным размерам</i></p>	<p>Brushed aluminium <i>Alluminio spazzolato</i> <i>Gebürstetes Aluminium</i> <i>Aluminio cepillado</i> <i>Крацованный алюминий</i></p>	2700 °K	1795.S4.2700	856,00	701,64
			3000 °K	1795.S4.3000	856,00	701,64
		<p>Black <i>Nero</i> <i>Schwarz</i> <i>Negro</i> <i>Чёрный цвет</i></p>	2700 °K	1810.S4.2700	942,00	772,13
			3000 °K	1810.S4.3000	942,00	772,13
		<p>Sand <i>Sabbia</i> <i>Sandfarben</i> <i>Arena</i> <i>Песочный цвет</i></p>	2700 °K	1811.S4.2700	942,00	772,13
			3000 °K	1811.S4.3000	942,00	772,13



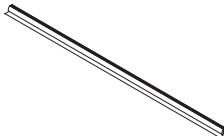

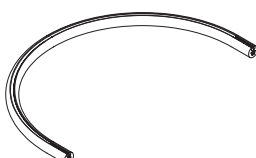
Horizontal suspension

Sospensione orizzontale / Horizontale Aufhängung / Suspensión horizontal / Горизонтальное подвешивание

PRODUCT		°K	CODE	PRICE € incl VAT (22%)	PRICE € excl VAT
 <p>LINEA System</p>	<p>Linear element <i>Elemento lineare</i> <i>Lineares Element</i> <i>Elemento lineal</i> <i>Линейный элемент</i></p> <p>120 cm - 24W</p>	2700 °K	1795.S1.2700	473,00	387,70
		3000 °K	1795.S1.3000	473,00	387,70
 <p>LINEA System</p>	<p>90° bend <i>Curva 90°</i> <i>Kurve 90°</i> <i>Curva 90°</i> <i>Угловой элемент 90°</i></p> <p>11W</p>	2700 °K	1795.S2.2700	326,00	267,21
		3000 °K	1795.S2.3000	326,00	267,21
 <p>LINEA System</p>	<p>180° bend <i>Curva 180°</i> <i>Kurve 180°</i> <i>Curva 180°</i> <i>Угловой элемент 180°</i></p> <p>20W</p>	2700 °K	1795.S3.2700	423,00	346,72
		3000 °K	1795.S3.3000	423,00	346,72

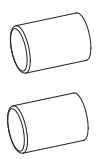
Horizontal suspension

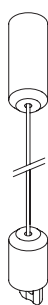
Accessories / Accessori / Zubehör / Accesorios / Аксессуары

ACCESSORIES	FINISHES	CODE	PRICE € incl VAT (22%)	PRICE € excl VAT
	Brushed aluminium Alluminio spazzolato Gebürstetes Aluminium Aluminio cepillado Крацованный алюминий	1795.M3	42,00	34,43
	Black Nero Schwarz Negro Чёрный цвет	1810.M3	42,00	34,43
	Sand Sabbia Sandfarben Arena Песочный цвет	1811.M3	42,00	34,43
	Brushed aluminium Alluminio spazzolato Gebürstetes Aluminium Aluminio cepillado Крацованный алюминий	1795.M4	77,00	63,11
	Black Nero Schwarz Negro Чёрный цвет	1810.M4	77,00	63,11
	Sand Sabbia Sandfarben Arena Песочный цвет	1811.M4	77,00	63,11
	Brushed aluminium Alluminio spazzolato Gebürstetes Aluminium Aluminio cepillado Крацованный алюминий	1795.M5	23,00	18,85
	Black Nero Schwarz Negro Чёрный цвет	1810.M5	23,00	18,85
	Sand Sabbia Sandfarben Arena Песочный цвет	1811.M5	23,00	18,85
	Brushed aluminium Alluminio spazzolato Gebürstetes Aluminium Aluminio cepillado Крацованный алюминий	1795.M6	61,00	50,00
	Black Nero Schwarz Negro Чёрный цвет	1810.M6	61,00	50,00
	Sand Sabbia Sandfarben Arena Песочный цвет	1811.M6	61,00	50,00
	Brushed aluminium Alluminio spazzolato Gebürstetes Aluminium Aluminio cepillado Крацованный алюминий	1795.M7	20,00	16,39
	Black Nero Schwarz Negro Чёрный цвет	1810.M7	20,00	16,39
	Sand Sabbia Sandfarben Arena Песочный цвет	1811.M7	20,00	16,39

* Up to 2 m, calculate 2 pcs + (1 x m) / over 3 m, calculate 1 pc + (1 x m) / Fino a 2 m calcolare 2 pcs + (1 x m) / oltre i 3 m calcolare 1 pc + (1 x m) / Bis zu 2 m 2 Stck. berechnen (1 pro m) / bei mehr als 3 m 1 Stck. + (1 pro m) berechnen / Hasta 2 m calcular 2 uds. + (1 x m) / Encima de 3 m calcular 1 ud. + (1 x m) / До 2 м нужно учитывать 2 шт. + (1 x м) / свыше 3 м нужно учитывать 1 шт. + (1 x м)

Horizontal suspension

Drivers and canopies / Driver e rosoni / Driver und Baldachin / Driver y Floròn / Драйверы и основания

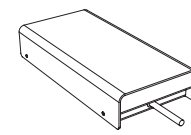
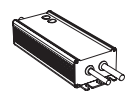
ACCESSORIES	FINISHES	W	Max MT	CODE	PRICE € incl VAT (22%)	PRICE € excl VAT
	Brushed aluminium Alluminio spazzolato Gebürstetes Aluminium Aluminio cepillado Крацованный алюминий	75W ON-OFF	Max 3.5 mt	1795.B1	140,00	114,75
		150W ON-OFF	Max 7.5 mt	1795.B2	159,00	130,33
		200W ON-OFF	Max 10 mt	1795.B3	252,00	206,56
		60W Dimmer	Max 3 mt	1795.B4*	205,00	168,03
		120W Dimmer	Max 6 mt	1795.B5*	260,00	213,11
		240W Dimmer	Max 10 mt	1795.B6*	310,00	254,10
	Black Nero Schwarz Negro Чёрный цвет	75W ON-OFF	Max 3.5 mt	1810.B1	140,00	114,75
		150W ON-OFF	Max 7.5 mt	1810.B2	159,00	130,33
		200W ON-OFF	Max 10 mt	1810.B3	252,00	206,56
		60W Dimmer	Max 3 mt	1810.B4*	205,00	168,03
		120W Dimmer	Max 6 mt	1810.B5*	260,00	213,11
		240W Dimmer	Max 10 mt	1810.B6*	310,00	254,10
Sand Sabbia Sandfarben Arena Песочный цвет	75W ON-OFF	Max 3.5 mt	1811.B1	140,00	114,75	
	150W ON-OFF	Max 7.5 mt	1811.B2	159,00	130,33	
	200W ON-OFF	Max 10 mt	1811.B3	252,00	206,56	
	60W Dimmer	Max 3 mt	1811.B4*	205,00	168,03	
	120W Dimmer	Max 6 mt	1811.B5*	260,00	213,11	
	240W Dimmer	Max 10 mt	1811.B6*	310,00	254,10	
	Remote power supply Alimentatore remoto Entfernt liegendes Netzteil Fuente de alimentación colocada a distancia Удаленный блок питания	75W ON-OFF	Max 3.5 mt	1795.R1	54,00	44,26
		150W ON-OFF	Max 7.5 mt	1795.R2	73,00	59,84
		200W ON-OFF	Max 10 mt	1795.R3	165,00	135,25
		60W Dimmer	Max 3 mt	1795.R4*	113,00	92,62
		120W Dimmer	Max 6 mt	1795.R5*	168,00	137,70
		240W Dimmer	Max 12 mt	1795.R6*	218,00	178,69

* Dimmable with: 1 ~ 10Vdc, 10V PWM signal and resistance
Dimmerabile con: 1 ~ 10Vdc, 10V PWM segnale e resistenza
Dimmbar über: 1~10Vdc, 10V PWM-Signal und Widerstand
Intensidad luminosa regulable con: 1 ~ 10 Vcc, 10 V PWM señal y resistencia
Диммируется с помощью 1 ~ 10Vdc, 10V ШИМ-сигнала и резистора

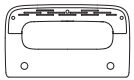
PRODUCT	FINISHES	°K	CODE	PRICE € incl VAT (22%)	PRICE € excl VAT
 <p>22,3 cm</p> <p>AKI Applique</p>	White Bianco Weiß Blanco Белый цвет	2700 °K	1796.10.2700	272,00	222,95
			1796.10.2700.D*	362,00	296,72
		3000 °K	1796.10.3000	272,00	222,95
			1796.10.3000.D*	362,00	296,72
		4000 °K	1796.10.4000	272,00	222,95
			1796.10.4000.D*	362,00	296,72
	Sand Sabbia Sandfarben Arena Песочный цвет	2700 °K	1797.10.2700	272,00	222,95
			1797.10.2700.D*	362,00	296,72
		3000 °K	1797.10.3000	272,00	222,95
			1797.10.3000.D*	362,00	296,72
		4000 °K	1797.10.4000	272,00	222,95
			1797.10.4000.D*	362,00	296,72
	Brown Moro Braun Marrón oscuro Тёмно-коричневый цвет	2700 °K	1798.10.2700	272,00	222,95
			1798.10.2700.D*	362,00	296,72
		3000 °K	1798.10.3000	272,00	222,95
			1798.10.3000.D*	362,00	296,72
		4000 °K	1798.10.4000	272,00	222,95
			1798.10.4000.D*	362,00	296,72
	Petrol Blue Blu Ottanio Oktanblau Azul verdoso Сине-зеленый	2700 °K	1803.10.2700	272,00	222,95
			1803.10.2700.D*	362,00	296,72
3000 °K		1803.10.3000	272,00	222,95	
		1803.10.3000.D*	362,00	296,72	
4000 °K		1803.10.4000	272,00	222,95	
		1803.10.4000.D*	362,00	296,72	
Brick brown Mattone Ziegelstein Ladrillo Кирпичный цвет	2700 °K	1804.10.2700	272,00	222,95	
		1804.10.2700.D*	362,00	296,72	
	3000 °K	1804.10.3000	272,00	222,95	
		1804.10.3000.D*	362,00	296,72	
	4000 °K	1804.10.4000	272,00	222,95	
		1804.10.4000.D*	362,00	296,72	

* Dimmable with: Push 0-10V/1-10V/Dali/ normally open button
 Dimmerabile con: Push 0-10v / 1-10v/Dali / pulsante normalmente aperto
 Dimmbar über: Push 0-10V / 1-10V/Dali / Taste normalerweise offen
 Intensidad luminosa regulable con: Push 0-10v / 1-10v/Dali / botón normalmente abierto
 Диммируется с помощью Push 0-10в / 1-10в/Dali / с нормально разомкнутой кнопкой.

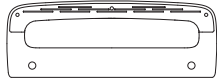
PRODUCT	FINISHES	°K	CODE	PRICE € incl VAT (22%)	PRICE € excl VAT
 <p>35,5 cm</p> <p>AKI Applique</p>	White Bianco Weiß Blanco Белый цвет	2700 °K	1796.11.2700	323,00	264,75
			1796.11.2700.D*	413,00	338,52
		3000 °K	1796.11.3000	323,00	264,75
			1796.11.3000.D*	413,00	338,52
		4000 °K	1796.11.4000	323,00	264,75
			1796.11.4000.D*	413,00	338,52
	Sand Sabbia Sandfarben Arena Песочный цвет	2700 °K	1797.11.2700	323,00	264,75
			1797.11.2700.D*	413,00	338,52
		3000 °K	1797.11.3000	323,00	264,75
			1797.11.3000.D*	413,00	338,52
		4000 °K	1797.11.4000	323,00	264,75
			1797.11.4000.D*	413,00	338,52
	Brown Moro Braun Marrón oscuro Тёмно-коричневый цвет	2700 °K	1798.11.2700	323,00	264,75
			1798.11.2700.D*	413,00	338,52
		3000 °K	1798.11.3000	323,00	264,75
			1798.11.3000.D*	413,00	338,52
		4000 °K	1798.11.4000	323,00	264,75
			1798.11.4000.D*	413,00	338,52
	Petrol Blue Blu Ottanio Oktanblau Azul verdoso Сине-зеленый	2700 °K	1803.11.2700	323,00	264,75
			1803.11.2700.D*	413,00	338,52
3000 °K		1803.11.3000	323,00	264,75	
		1803.11.3000.D*	413,00	338,52	
4000 °K		1803.11.4000	323,00	264,75	
		1803.11.4000.D*	413,00	338,52	
Brick brown Mattone Ziegelstein Ladrillo Кирпичный цвет	2700 °K	1804.11.2700	323,00	264,75	
		1804.11.2700.D*	413,00	338,52	
	3000 °K	1804.11.3000	323,00	264,75	
		1804.11.3000.D*	413,00	338,52	
	4000 °K	1804.11.4000	323,00	264,75	
		180411.4000.D*	413,00	338,52	

* Dimmable with: Push 0-10V/1-10V/Dali/ normally open button
 Dimmerabile con: Push 0-10v / 1-10v/Dali / pulsante normalmente aperto
 Dimmbar über: Push 0-10V / 1-10V/Dali / Taste normalerweise offen
 Intensidad luminosa regulable con: Push 0-10v / 1-10v/Dali / botón normalmente abierto
 Диммируется с помощью Push 0-10в / 1-10в/Dali / с нормально разомкнутой кнопкой.

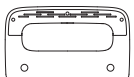
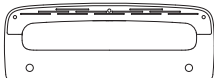

PRICE LIST_AKI SPECIAL EDITION

PRODUCT	FINISHES	°K	CODE	PRICE € incl VAT (22%)	PRICE € excl VAT
 <p>22,3 cm</p> <p>AKI S Applique</p> <p>SPECIAL EDITION</p>	Iron grey Grigio ferro Eisengrau Gris hierro Железно-серый	3000 °K	1823.10	286,00	234,43
 <p>35,5 cm</p> <p>AKI L Applique</p> <p>SPECIAL EDITION</p>	Iron grey Grigio ferro Eisengrau Gris hierro Железно-серый	3000 °K	1823.11	339,00	277,87

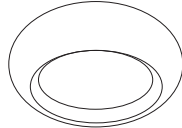
PRICE LIST_OLO

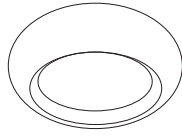
PRODUCT	FINISHES	°K	CODE	PRICE € incl VAT (22%)	PRICE € excl VAT	
 <p>OLO Wall</p>	White Bianco Weiß Blanco Белый цвет	2700 °K	1776.10.2700	251,00	205,74	
		3000 °K	1776.10.3000	251,00	205,74	
		4000 °K	1776.10.4000	251,00	205,74	
	Black Nero Schwarz Negro Чёрный цвет	2700 °K	1785.10.2700	251,00	205,74	
		3000 °K	1785.10.3000	251,00	205,74	
		4000 °K	1785.10.4000	251,00	205,74	
	Brushed gold Oro spazzolato Gold gebürstet Oro cepillado Брашированное золото	2700 °K	1791.10.2700	293,00	240,16	
		3000 °K	1791.10.3000	293,00	240,16	
		4000 °K	1791.10.4000	293,00	240,16	
	Brushed copper Rame spazzolato Kupfer gebürstet Cobre cepillado Брашированная медь	2700 °K	1792.10.2700	293,00	240,16	
		3000 °K	1792.10.3000	293,00	240,16	
		4000 °K	1792.10.4000	293,00	240,16	
Brushed bronze Bronzo spazzolato Bronze gebürstet Bronce cepillado Брашированная бронза	2700 °K	1793.10.2700	293,00	240,16		
	3000 °K	1793.10.3000	293,00	240,16		
	4000 °K	1793.10.4000	293,00	240,16		
Brushed black nickel Nichel nero spazzolato Nickel schwarz gebürstet Níquel negro cepillado Брашированный чёрный никель	2700 °K	1794.10.2700	293,00	240,16		
	3000 °K	1794.10.3000	293,00	240,16		
	4000 °K	1794.10.4000	293,00	240,16		
Remote dimmer controller. Controls up to 6 lamps Dimmer remoto. Gestisce fino a 6 lampade Dimmer Fernbedienung. Verwaltet bis zu 6 Leuchten Dimmer remoto. Controla hasta 6 bombillas Диммер дистанционного управления. Управляет максимум 6 лампами				1776.DIM	125,00	102,46
Casambi dimmer controller. Controls up to 4 lamps Dimmer casambi. Gestisce fino a 4 lampade Casambi Dimmer Bedienung. Verwaltet bis zu 4 Leuchten Dimmer casambi. Controla hasta 4 bombillas Контроллер-диммер Casambi. Управляет максимум 4 лампами				1776.CASAMBI	175,00	143,44

PRODUCT	FINISHES	°K	CODE	PRICE € incl VAT (22%)	PRICE € excl VAT
 <p>OLO Wall</p> <p>SPECIAL EDITION</p>	Iron grey Grigio ferro Eisengrau Gris hierro Железно-серый	3000 °K	1824.10	263,00	215,57

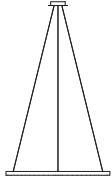
PRODUCT	FINISHES	°K	CODE	PRICE € incl VAT (22%)	PRICE € excl VAT	
 <p>ANELLO Suspension Ø 55</p>	Painted black Nero Verniciato Schwarz lackiert Negro Pintado Окрашенный в черный цвет	3000 °K	1790.30	504,00	413,11	
		3000 °K	1790.30.D*	604,00	495,08	
	Brushed bronze Bronzo spazzolato Bronze gebürstet Bronce cepillado Брашированная бронза	3000 °K	1799.30	548,00	449,18	
		3000 °K	1799.30.D*	648,00	531,15	
	Brushed gold Oro spazzolato Gold gebürstet Oro cepillado Брашированное золото	3000 °K	1800.30	548,00	449,18	
		3000 °K	1800.30.D*	648,00	531,15	
	Brushed copper Rame spazzolato Kupfer gebürstet Cobre cepillado Брашированная медь	3000 °K	1801.30	548,00	449,18	
		3000 °K	1801.30.D*	648,00	531,15	
	 <p>ANELLO Suspension Ø 78</p>	Painted black Nero Verniciato Schwarz lackiert Negro Pintado Окрашенный в черный цвет	3000 °K	1790.31	636,00	521,31
			3000 °K	1790.31.D*	736,00	603,28
		Brushed bronze Bronzo spazzolato Bronze gebürstet Bronce cepillado Брашированная бронза	3000 °K	1799.31	795,00	651,64
			3000 °K	1799.31.D*	895,00	733,61
Brushed gold Oro spazzolato Gold gebürstet Oro cepillado Брашированное золото		3000 °K	1800.31	795,00	651,64	
		3000 °K	1800.31.D*	895,00	733,61	
Brushed copper Rame spazzolato Kupfer gebürstet Cobre cepillado Брашированная медь		3000 °K	1801.31	795,00	651,64	
		3000 °K	1801.31.D*	895,00	733,61	
 <p>ANELLO Suspension Ø 109</p>		Painted black Nero Verniciato Schwarz lackiert Negro Pintado Окрашенный в черный цвет	3000 °K	1790.32	876,00	718,03
			3000 °K	1790.32.D*	976,00	800,00
		Brushed bronze Bronzo spazzolato Bronze gebürstet Bronce cepillado Брашированная бронза	3000 °K	1799.32	942,00	772,13
			3000 °K	1799.32.D*	1.042,00	854,10
	Brushed gold Oro spazzolato Gold gebürstet Oro cepillado Брашированное золото	3000 °K	1800.32	942,00	772,13	
		3000 °K	1800.32.D*	1.042,00	854,10	
	Brushed copper Rame spazzolato Kupfer gebürstet Cobre cepillado Брашированная медь	3000 °K	1801.32	942,00	772,13	
		3000 °K	1801.32.D*	1.042,00	854,10	

* Dimmable with: Push 0-10V/1-10V/Dali/ normally open button
 Dimmerabile con: Push 0-10v / 1-10v/Dali / pulsante normalmente aperto
 Dimmbar über: Push 0-10V / 1-10V/Dali / Taste normalerweise offen
 Intensidad luminosa regulable con: Push 0-10v / 1-10v/Dali / botón normalmente abierto
 Диммируется с помощью Push 0-10в / 1-10в/Dali / с нормально разомкнутой кнопкой.

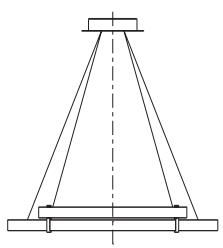
PRODUCT	FINISHES	°K	CODE	PRICE € incl VAT (22%)	PRICE € excl VAT
 <p>ANELLO Double Suspension</p>	Painted black <i>Nero Verniciato</i> <i>Schwarz lackiert</i> <i>Negro Pintado</i> <i>Окрашенный в черный цвет</i>	3000 °K	1790.33	1.139,00	933,61
		3000 °K	1790.33.D*	1.239,00	1.015,57
	Brushed bronze <i>Bronzo spazzolato</i> <i>Bronze gebürstet</i> <i>Bronce cepillado</i> <i>Брашированная бронза</i>	3000 °K	1799.33	1.343,00	1.100,82
		3000 °K	1799.33.D*	1.443,00	1.182,79
	Brushed gold <i>Oro spazzolato</i> <i>Gold gebürstet</i> <i>Oro cepillado</i> <i>Брашированное золото</i>	3000 °K	1800.33	1.343,00	1.100,82
		3000 °K	1800.33.D*	1.443,00	1.182,79
	Brushed copper <i>Rame spazzolato</i> <i>Kupfer gebürstet</i> <i>Cobre cepillado</i> <i>Брашированная медь</i>	3000 °K	1801.33	1.343,00	1.100,82
		3000 °K	1801.33.D*	1.443,00	1.182,79

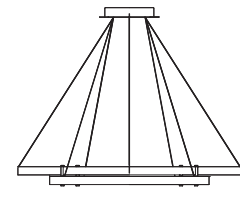
PRODUCT	FINISHES	°K	CODE	PRICE € incl VAT (22%)	PRICE € excl VAT
 <p>ANELLO Triple Suspension</p>	Painted black <i>Nero Verniciato</i> <i>Schwarz lackiert</i> <i>Negro Pintado</i> <i>Окрашенный в черный цвет</i>	3000 °K	1790.34	2.015,00 €	1.651,64
		3000 °K	1790.34.D*	2.115,00	1.733,61
	Brushed bronze <i>Bronzo spazzolato</i> <i>Bronze gebürstet</i> <i>Bronce cepillado</i> <i>Брашированная бронза</i>	3000 °K	1799.34	2.284,00	1.872,13
		3000 °K	1799.34.D*	2.384,00	1.954,10
	Brushed gold <i>Oro spazzolato</i> <i>Gold gebürstet</i> <i>Oro cepillado</i> <i>Брашированное золото</i>	3000 °K	1800.34	2.284,00	1.872,13
		3000 °K	1800.34.D*	2.384,00	1.954,10
	Brushed copper <i>Rame spazzolato</i> <i>Kupfer gebürstet</i> <i>Cobre cepillado</i> <i>Брашированная медь</i>	3000 °K	1801.34	2.284,00	1.872,13
		3000 °K	1801.34.D*	2.384,00	1.954,10

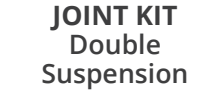
PRODUCT	FINISHES	°K	CODE	PRICE € incl VAT (22%)	PRICE € excl VAT
 <p>JOINT KIT Double Suspension</p>	Set of two clasps for Black Anello series Suspension. Set due ganci per sospensione serie Anello colore Nero. Satz mit zwei Haken für die Aufhängung Serie Anello Farbe Schwarz. Juego de dos ganchos para suspensión serie Anello color negro. Комплект из двух зажимов для Подвесного элемента серии Anello цвет Черный.		ART.1825.BLACK	66,00	54,10
	Set of two clasps for Gold Anello series Suspension. Set due ganci per sospensione serie Anello colore Oro. Satz mit zwei Haken für die Aufhängung Serie Anello Farbe Gold. Juego de dos ganchos para suspensión serie Anello color oro. Комплект из двух зажимов для Подвесного элемента серии Anello цвет Золотистый.		ART.1825.GOLD	66,00 €	54,10
	Set of two clasps for Copper Anello series Suspension. Set due ganci per sospensione serie Anello colore Rame. Satz mit zwei Haken für die Aufhängung Serie Anello Farbe Kupfer. Juego de dos ganchos para suspensión serie Anello color cobre. Комплект из двух зажимов для Подвесного элемента серии Anello цвет Медный.		ART.1825.COPPER	66,00	54,10
	Set of two clasps for Aluminium Anello series Suspension. Set due ganci per sospensione serie Anello colore Alluminio. Satz mit zwei Haken für die Aufhängung Serie Anello Farbe Aluminium. Juego de dos ganchos para suspensión serie Anello color aluminio. Комплект из двух зажимов для Подвесного элемента серии Anello цвет Алюминиевый.		ART.1825.ALLUM	66,00	54,10
	Set of two clasps for Bronze Anello series Suspension. Set due ganci per sospensione serie Anello colore Bronzo. Satz mit zwei Haken für die Aufhängung Serie Anello Farbe Bronze. Juego de dos ganchos para suspensión serie Anello color Bronce. Комплект из двух зажимов для Подвесного элемента серии Anello цвет Бронзовый.		ART.1825.BRONZ	66,00	54,10

PRODUCT	FINISHES	°K	CODE	PRICE € incl VAT (22%)	PRICE € excl VAT
 <p>JOINT KIT Triple Suspension</p>	Set of four clasps for Black Anello series Suspension. Set quattro ganci per Sospension serie Anello colore Nero. Satz mit vier Haken für die Aufhängung Serie Anello Farbe Schwarz. Juego de cuatro ganchos para suspensión serie Anello color negro. Комплект из четырех зажимов для Подвесного элемента серии Anello цвет Черный.		ART.1826.BLACK	120,00	98,36
	Set of four clasps for Gold Anello series Suspension. Set quattro ganci per Sospension serie Anello colore Oro. Satz mit vier Haken für die Aufhängung Serie Anello Farbe Gold. Juego de cuatro ganchos para suspensión serie Anello color oro. Комплект из четырех зажимов для Подвесного элемента серии Anello цвет Золотистый.		ART.1826.GOLD	120,00	98,36
	Set of four clasps for Copper Anello series Suspension. Set quattro ganci per Sospension serie Anello colore Rame. Satz mit vier Haken für die Aufhängung Serie Anello Farbe Kupfer. Juego de cuatro ganchos para suspensión serie Anello color cobre. Комплект из четырех зажимов для Подвесного элемента серии Anello цвет Медный.		ART.1826.COPPER	120,00	98,36
	Set of four clasps for Aluminium Anello series Suspension. Set quattro ganci per Sospension serie Anello colore Alluminio. Satz mit vier Haken für die Aufhängung Serie Anello Farbe Aluminium. Juego de cuatro ganchos para suspensión serie Anello color aluminio. Комплект из четырех зажимов для Подвесного элемента серии Anello цвет Алюминиевый.		ART.1826.ALLUM	120,00	98,36
	Set of four clasps for Bronze Anello series Suspension. Set quattro ganci per Sospension serie Anello colore Bronzo. Satz mit vier Haken für die Aufhängung Serie Anello Farbe Bronze. Juego de cuatro ganchos para suspensión serie Anello color Bronce. Комплект из четырех зажимов для Подвесного элемента серии Anello цвет Бронзовый.		ART.1826.BRONZ	120,00	98,36

* Dimmable with: Push 0-10V/1-10V/Dali/ normally open button
Dimmerabile con: Push 0-10v / 1-10v/Dali / pulsante normalmente aperto
Dimmbar über: Push 0-10V / 1-10V/Dali / Taste normalerweise offen
Intensidad luminosa regulable con: Push 0-10v / 1-10v/Dali / botón normalmente abierto
Диммируется с помощью Push 0-10v / 1-10v/Dali / с нормально разомкнутой кнопкой.

* Dimmable with: Push 0-10V/1-10V/Dali/ normally open button
Dimmerabile con: Push 0-10v / 1-10v/Dali / pulsante normalmente aperto
Dimmbar über: Push 0-10V / 1-10V/Dali / Taste normalerweise offen
Intensidad luminosa regulable con: Push 0-10v / 1-10v/Dali / botón normalmente abierto
Диммируется с помощью Push 0-10v / 1-10v/Dali / с нормально разомкнутой кнопкой.

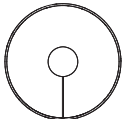
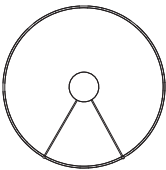
PRODUCT	FINISHES	°K	CODE	PRICE € incl VAT (22%)	PRICE € excl VAT
 <p>ANELLO Ceiling Ø 55</p>	Painted black Nero Verniciato Schwarz lackiert Negro Pintado Окрашенный в черный цвет	3000 °K	1790.20	611,00	500,82
		3000 °K	1790.20.D*	711,00	582,79
	Brushed bronze Bronzo spazzolato Bronze gebürstet Bronce cepillado Брашированная бронза	3000 °K	1799.20	840,00	688,52
		3000 °K	1799.20.D*	940,00	770,49
	Brushed gold Oro spazzolato Gold gebürstet Oro cepillado Брашированное золото	3000 °K	1800.20	840,00	688,52
		3000 °K	1800.20.D*	940,00	770,49
Brushed copper Rame spazzolato Kupfer gebürstet Cobre cepillado Брашированная медь	3000 °K	1801.20	840,00	688,52	
	3000 °K	1801.20.D*	940,00	770,49	
 <p>ANELLO Ceiling Ø 78</p>	Painted black Nero Verniciato Schwarz lackiert Negro Pintado Окрашенный в черный цвет	3000 °K	1790.21	758,00	621,31
		3000 °K	1790.21.D*	858,00	703,28
	Brushed bronze Bronzo spazzolato Bronze gebürstet Bronce cepillado Брашированная бронза	3000 °K	1799.21	1.013,00	830,33
		3000 °K	1799.21.D*	1.113,00	912,30
	Brushed gold Oro spazzolato Gold gebürstet Oro cepillado Брашированное золото	3000 °K	1800.21	1.013,00	830,33
		3000 °K	1800.21.D*	1.113,00	912,30
Brushed copper Rame spazzolato Kupfer gebürstet Cobre cepillado Брашированная медь	3000 °K	1801.21	1.013,00	830,33	
	3000 °K	1801.21.D*	1.113,00	912,30	
 <p>ANELLO Ceiling Ø 109</p>	Painted black Nero Verniciato Schwarz lackiert Negro Pintado Окрашенный в черный цвет	3000 °K	1790.22	1.032,00	845,90
		3000 °K	1790.22.D*	1.132,00	927,87
	Brushed bronze Bronzo spazzolato Bronze gebürstet Bronce cepillado Брашированная бронза	3000 °K	1799.22	1.109,00	909,02
		3000 °K	1799.22.D*	1.209,00	990,98
	Brushed gold Oro spazzolato Gold gebürstet Oro cepillado Брашированное золото	3000 °K	1800.22	1.109,00	909,02
		3000 °K	1800.22.D*	1.209,00	990,98
Brushed copper Rame spazzolato Kupfer gebürstet Cobre cepillado Брашированная медь	3000 °K	1801.22	1.109,00	909,02	
	3000 °K	1801.22.D*	1.209,00 €	990,98	

* Dimmable with: Push 0-10V/1-10V/Dali/ normally open button
 Dimmerabile con: Push 0-10v / 1-10v/Dali / pulsante normalmente aperto
 Dimmbar über: Push 0-10V / 1-10V/Dali / Taste normalerweise offen
 Intensidad luminosa regulable con: Push 0-10v / 1-10v/Dali / botón normalmente abierto
 Диммируется с помощью Push 0-10в / 1-10в/Dali / с нормально разомкнутой кнопкой.

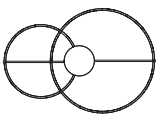
PRODUCT	FINISHES	°K	CODE	PRICE € incl VAT (22%)	PRICE € excl VAT
 <p>ANELLO Double Ceiling</p>	Painted black Nero Verniciato Schwarz lackiert Negro Pintado Окрашенный в черный цвет	3000 °K	1790.23	1.368,00	1.121,31
		3000 °K	1790.23.D*	1.468,00	1.203,28
	Brushed bronze Bronzo spazzolato Bronze gebürstet Bronce cepillado Брашированная бронза	3000 °K	1799.23	1.852,00	1.518,03
		3000 °K	1799.23.D*	1.952,00	1.600,00
	Brushed gold Oro spazzolato Gold gebürstet Oro cepillado Брашированное золото	3000 °K	1800.23	1.852,00	1.518,03
		3000 °K	1800.23.D*	1.952,00	1.600,00
Brushed copper Rame spazzolato Kupfer gebürstet Cobre cepillado Брашированная медь	3000 °K	1801.23	1.852,00	1.518,03	
	3000 °K	1801.23.D*	1.952,00	1.600,00	

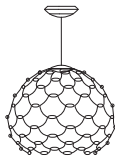
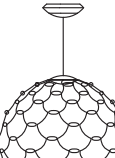

* Dimmable with: Push 0-10V/1-10V/Dali/ normally open button
 Dimmerabile con: Push 0-10v / 1-10v/Dali / pulsante normalmente aperto
 Dimmbar über: Push 0-10V / 1-10V/Dali / Taste normalerweise offen
 Intensidad luminosa regulable con: Push 0-10v / 1-10v/Dali / botón normalmente abierto
 Диммируется с помощью Push 0-10в / 1-10в/Dali / с нормально разомкнутой кнопкой.

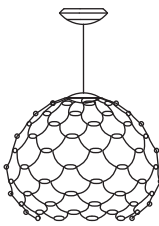
PRODUCT	FINISHES	°K	CODE	PRICE € incl VAT (22%)	PRICE € excl VAT	
 <p>LAMO I Suspension Ø 40</p>	Gold Oro Gold Oro Золото	2700 °K	1812.30.2700	987,00	809,02	
			1812.30.2700.D*	1.107,00	907,38	
		3000 °K	1812.30.3000	987,00	809,02	
			1812.30.3000.D*	1.107,00	907,38	
	Plastic covers, Coperture plastica, Kunststoffabdeckungen, difusores en plástico, Пластиковые крышки			1812.30.KIT COVER	208,00	170,49
	Black Nero Schwarz Negro Чёрный цвет	2700 °K	1815.30.2700	987,00	809,02	
			1815.30.2700.D*	1.107,00	907,38	
		3000 °K	1815.30.3000	987,00	809,02	
			1815.30.3000.D*	1.107,00	907,38	
	Plastic covers, Coperture plastica, Kunststoffabdeckungen, difusores en plástico, Пластиковые крышки			1815.30.KIT COVER	208,00	170,49
	Copper Rame Kupfer Cobre Медь	2700 °K	1816.30.2700	987,00	809,02	
			1816.30.2700.D*	1.107,00	907,38	
3000 °K		1816.30.3000	987,00	809,02		
		1816.30.3000.D*	1.107,00	907,38		
Plastic covers, Coperture plastica, Kunststoffabdeckungen, difusores en plástico, Пластиковые крышки			1816.30.KIT COVER	208,00	170,49	
Chrome Cromo Chrom Cromo Хром	2700 °K	1817.30.2700	987,00	809,02		
		1817.30.2700.D*	1.107,00	907,38		
	3000 °K	1817.30.3000	987,00	809,02		
		1817.30.3000.D*	1.107,00	907,38		
Plastic covers, Coperture plastica, Kunststoffabdeckungen, difusores en plástico, Пластиковые крышки			1817.30.KIT COVER	208,00	170,49	
 <p>LAMO I Suspension Ø 60</p>	Gold Oro Gold Oro Золото	2700 °K	1812.31.2700	1.253,00	1.027,05	
			1812.31.2700.D*	1.373,00	1.125,41	
		3000 °K	1812.31.3000	1.253,00	1.027,05	
			1812.31.3000.D*	1.373,00	1.125,41	
	Plastic covers, Coperture plastica, Kunststoffabdeckungen, difusores en plástico, Пластиковые крышки			1812.31.KIT COVER	305,00	250,00
	Black Nero Schwarz Negro Чёрный цвет	2700 °K	1815.31.2700	1.253,00	1.027,05	
			1815.31.2700.D*	1.373,00	1.125,41	
		3000 °K	1815.31.3000	1.253,00	1.027,05	
			1815.31.3000.D*	1.373,00	1.125,41	
	Plastic covers, Coperture plastica, Kunststoffabdeckungen, difusores en plástico, Пластиковые крышки			1815.31.KIT COVER	305,00	250,00
	Copper Rame Kupfer Cobre Медь	2700 °K	1816.31.2700	1.253,00	1.027,05	
			1816.31.2700.D*	1.373,00	1.125,41	
3000 °K		1816.31.3000	1.253,00	1.027,05		
		1816.31.3000.D*	1.373,00	1.125,41		
Plastic covers, Coperture plastica, Kunststoffabdeckungen, difusores en plástico, Пластиковые крышки			1816.31.KIT COVER	305,00	250,00	
Chrome Cromo Chrom Cromo Хром	2700 °K	1817.31.2700	1.253,00	1.027,05		
		1817.31.2700.D*	1.373,00	1.125,41		
	3000 °K	1817.31.3000	1.253,00	1.027,05		
		1817.31.3000.D*	1.373,00	1.125,41		
4000 °K	1817.31.4000	1.253,00	1.027,05			
	Plastic covers, Coperture plastica, Kunststoffabdeckungen, difusores en plástico, Пластиковые крышки			1817.31.4000	305,00	250,00

PRODUCT	FINISHES	°K	CODE	PRICE € incl VAT (22%)	PRICE € excl VAT	
 <p>LAMO I Suspension Ø 80</p>	Gold Oro Gold Oro Золото	2700 °K	1812.32.2700	1.678,00	1.375,41	
			1812.32.2700.D*	1.798,00	1.473,77	
		3000 °K	1812.32.3000	1.678,00	1.375,41	
			1812.32.3000.D*	1.798,00	1.473,77	
	Plastic covers, Coperture plastica, Kunststoffabdeckungen, difusores en plástico, Пластиковые крышки			1812.32.KIT COVER	420,00	344,26
	Black Nero Schwarz Negro Чёрный цвет	2700 °K	1815.32.2700	1.678,00	1.375,41	
			1815.32.2700.D*	1.798,00	1.473,77	
		3000 °K	1815.32.3000	1.678,00	1.375,41	
			1815.32.3000.D*	1.798,00	1.473,77	
	Plastic covers, Coperture plastica, Kunststoffabdeckungen, difusores en plástico, Пластиковые крышки			1815.32.KIT COVER	420,00	344,26
	Copper Rame Kupfer Cobre Медь	2700 °K	1816.32.2700	1.678,00	1.375,41	
			1816.32.2700.D*	1.798,00	1.473,77	
3000 °K		1816.32.3000	1.678,00	1.375,41		
		A1816.32.3000.D*	1.798,00	1.473,77		
Plastic covers, Coperture plastica, Kunststoffabdeckungen, difusores en plástico, Пластиковые крышки			1816.32.KIT COVER	421,00	345,08	
Chrome Cromo Chrom Cromo Хром	2700 °K	1817.32.2700	1.678,00	1.375,41		
		1817.32.2700.D*	1.798,00	1.473,77		
	3000 °K	1817.32.3000	1.678,00	1.375,41		
		1817.32.3000.D*	1.798,00	1.473,77		
Plastic covers, Coperture plastica, Kunststoffabdeckungen, difusores en plástico, Пластиковые крышки			1817.32.KIT COVER	421,00	345,08	

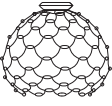
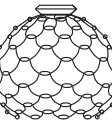
* Dimmable with: Push 0-10V/1-10V/Dali/ normally open button
 Dimmerabile con: Push 0-10v / 1-10v/Dali / pulsante normalmente aperto
 Dimmbar über: Push 0-10V / 1-10V/Dali / Taste normalerweise offen
 Intensidad luminosa regulable con: Push 0-10v / 1-10v/Dali / botón normalmente abierto
 Диммируется с помощью Push 0-10в / 1-10в/Dali / с нормально разомкнутой кнопкой.

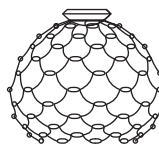
PRODUCT	FINISHES	°K	CODE	PRICE € incl VAT (22%)	PRICE € excl VAT	
 LAMO I Ceiling Ø 40	Gold Oro Gold Oro Золото	2700 °K	1812.20.2700	879,00	720,49	
			1812.20.2700.D*	1.000,00	819,67	
		3000 °K	1812.20.3000	879,00	720,49	
			1812.20.3000.D*	1.000,00	819,67	
	Plastic covers, Coperture plastica, Kunststoffabdeckungen, difusores en plástico, Пластиковые крышки			1812.20.KIT COVER	208,00	170,49
	Black Nero Schwarz Negro Чёрный цвет	2700 °K	1815.20.2700	879,00	720,49	
			1815.20.2700.D*	1.000,00	819,67	
		3000 °K	1815.20.3000	879,00	720,49	
			1815.20.3000.D*	1.000,00	819,67	
	Plastic covers, Coperture plastica, Kunststoffabdeckungen, difusores en plástico, Пластиковые крышки			1815.20.KIT COVER	208,00	170,49
	Copper Rame Kupfer Cobre Медь	2700 °K	1816.20.2700	879,00	720,49	
			1816.20.2700.D*	1.000,00	819,67	
3000 °K		1816.20.3000	879,00	720,49		
		1816.20.3000.D*	1.000,00	819,67		
Plastic covers, Coperture plastica, Kunststoffabdeckungen, difusores en plástico, Пластиковые крышки			1816.20.KIT COVER	208,00	170,49	
Chrome Cromo Chrom Cromo Хром	2700 °K	1817.20.2700	879,00	720,49		
		1817.20.2700.D*	1.000,00	819,67		
	3000 °K	1817.20.3000	879,00	720,49		
		1817.20.3000.D*	1.000,00	819,67		
Plastic covers, Coperture plastica, Kunststoffabdeckungen, difusores en plástico, Пластиковые крышки			1817.20.KIT COVER	208,00	170,49	
 LAMO I Ceiling Ø 60	Gold Oro Gold Oro Золото	2700 °K	1812.21.2700	1.110,00	909,84	
			1812.21.2700.D*	1.231,00	1.009,02	
		3000 °K	1812.21.3000	1.110,00	909,84	
			1812.21.3000.D*	1.231,00	1.009,02	
	Plastic covers, Coperture plastica, Kunststoffabdeckungen, difusores en plástico, Пластиковые крышки			1812.21.KIT COVER	305,00	250,00
	Black Nero Schwarz Negro Чёрный цвет	2700 °K	1815.21.2700	1.110,00	909,84	
			1815.21.2700.D*	1.231,00	1.009,02	
		3000 °K	1815.21.3000	1.110,00	909,84	
			1815.21.3000.D*	1.231,00	1.009,02	
	Plastic covers, Coperture plastica, Kunststoffabdeckungen, difusores en plástico, Пластиковые крышки			1815.21.KIT COVER	305,00	250,00
	Copper Rame Kupfer Cobre Медь	2700 °K	1816.21.2700	1.110,00	909,84	
			1816.21.2700.D*	1.231,00	1.009,02	
3000 °K		1816.21.3000	1.110,00	909,84		
		1816.21.3000.D*	1.231,00	1.009,02		
Plastic covers, Coperture plastica, Kunststoffabdeckungen, difusores en plástico, Пластиковые крышки			1816.21.KIT COVER	305,00	250,00	
Chrome Cromo Chrom Cromo Хром	2700 °K	1817.21.2700	1.110,00	909,84		
		1817.21.2700.D*	1.231,00	1.009,02		
	3000 °K	1817.21.3000	1.110,00	909,84		
		1817.21.3000.D*	1.231,00	1.009,02		
Plastic covers, Coperture plastica, Kunststoffabdeckungen, difusores en plástico, Пластиковые крышки			1817.21.KIT COVER	305,00	250,00	

PRODUCT	FINISHES	°K	CODE	PRICE € incl VAT (22%)	PRICE € excl VAT	
 LAMO I Ceiling Ø 80	Gold Oro Gold Oro Золото	2700 °K	1812.22.2700	1.488,00	1.219,67	
			1812.22.2700.D	1.609,00	1.318,85	
		3000 °K	1812.22.3000	1.488,00	1.219,67	
			1812.22.3000.D	1.609,00	1.318,85	
	Plastic covers, Coperture plastica, Kunststoffabdeckungen, difusores en plástico, Пластиковые крышки			1812.22.KIT COVER	420,00	344,26
	Black Nero Schwarz Negro Чёрный цвет	2700 °K	1815.22.2700	1.488,00	1.219,67	
			1815.22.2700.D*	1.609,00	1.318,85	
		3000 °K	1815.22.3000	1.488,00	1.219,67	
			1815.22.3000.D*	1.609,00	1.318,85	
	Plastic covers, Coperture plastica, Kunststoffabdeckungen, difusores en plástico, Пластиковые крышки			1815.22.KIT COVER	420,00	344,26
	Copper Rame Kupfer Cobre Медь	2700 °K	1816.22.2700	1.488,00	1.219,67	
			1816.22.2700.D*	1.609,00	1.318,85	
3000 °K		1816.22.3000	1.488,00	1.219,67		
		1816.22.3000.D*	1.609,00	1.318,85		
Plastic covers, Coperture plastica, Kunststoffabdeckungen, difusores en plástico, Пластиковые крышки			1816.22.KIT COVER	420,00	344,26	
Chrome Cromo Chrom Cromo Хром	2700 °K	1817.22.2700	1.488,00	1.219,67		
		1817.22.2700.D*	1.609,00	1.318,85		
	3000 °K	1817.22.3000	1.488,00	1.219,67		
		1817.22.3000.D*	1.609,00 €	1.318,85		
Plastic covers, Coperture plastica, Kunststoffabdeckungen, difusores en plástico, Пластиковые крышки			1817.22.KIT COVER	420,00	344,26	
 LAMO I Floor Ø 40	Gold Oro Gold Oro Золото	2700 °K	1812.53.2700.D*	1.349,00	1.105,74	
			1812.53.3000.D*	1.349,00	1.105,74	
		3000 °K	1812.53.2700.D*	1.349,00	1.105,74	
			1812.53.3000.D*	1.349,00	1.105,74	
	Plastic covers, Coperture plastica, Kunststoffabdeckungen, difusores en plástico, Пластиковые крышки			1812.53.KIT COVER	208,00	170,49
	Black Nero Schwarz Negro Чёрный цвет	2700 °K	1815.53.2700.D*	1.349,00	1.105,74	
			1815.53.3000.D*	1.349,00	1.105,74	
		3000 °K	1815.53.2700.D*	1.349,00	1.105,74	
			1815.53.3000.D*	1.349,00	1.105,74	
	Plastic covers, Coperture plastica, Kunststoffabdeckungen, difusores en plástico, Пластиковые крышки			1815.53.KIT COVER	208,00	170,49
	Copper Rame Kupfer Cobre Медь	2700 °K	1816.53.2700.D*	1.349,00	1.105,74	
			1816.53.3000.D*	1.349,00	1.105,74	
3000 °K		1816.53.2700.D*	1.349,00	1.105,74		
		1816.53.3000.D*	1.349,00	1.105,74		
Plastic covers, Coperture plastica, Kunststoffabdeckungen, difusores en plástico, Пластиковые крышки			1816.53.KIT COVER	208,00	170,49	
Chrome Cromo Chrom Cromo Хром	2700 °K	1817.53.2700.D*	1.349,00	1.105,74		
		1817.53.3000.D*	1.349,00	1.105,74		
	3000 °K	1817.53.2700.D*	1.349,00	1.105,74		
		1817.53.3000.D*	1.349,00	1.105,74		
Plastic covers, Coperture plastica, Kunststoffabdeckungen, difusores en plástico, Пластиковые крышки			1817.53.KIT COVER	208,00	170,49	

* Dimmable with: Push 0-10V/1-10V/Dali/ normally open button
 Dimmerabile con: Push 0-10v / 1-10v/Dali / pulsante normalmente aperto
 Dimmbar über: Push 0-10V / 1-10V/Dali / Taste normalerweise offen
 Intensidad luminosa regulable con: Push 0-10v / 1-10v/Dali / botón normalmente abierto
 Диммируется с помощью Push 0-10v / 1-10v/Dali / с нормально разомкнутой кнопкой.

PRODUCT	FINISHES	°K	CODE	PRICE € incl VAT (22%)	PRICE € excl VAT
 <p>TESA MINI Suspension</p>	Chrome Cromo Chrom Cromo Хром	2700 °K	1760.31.2700	605,00	495,90
			1760.31.2700.D*	715,00	586,07
		3000 °K	1760.31.3000	605,00	495,90
			1760.31.3000.D*	715,00	586,07
	Black Nero Schwarz Negro Чёрный цвет	2700 °K	1761.31.2700	605,00	495,90
			1761.31.2700.D*	715,00	586,07
		3000 °K	1761.31.3000	605,00	495,90
			1761.31.3000.D*	715,00	586,07
	Copper Rame Kupfer Cobre Медь	2700 °K	1769.31.2700	605,00	495,90
			1769.31.2700.D*	715,00	586,07
		3000 °K	1769.31.3000	605,00	495,90
			1769.31.3000.D*	715,00	586,07
 <p>TESA MINI Ceiling</p>	Chrome Cromo Chrom Cromo Хром	2700 °K	1760.21.2700	605,00	495,90
			1760.21.2700.D*	715,00	586,07
		3000 °K	1760.21.3000	605,00	495,90
			1760.21.3000.D*	715,00	586,07
	Black Nero Schwarz Negro Чёрный цвет	2700 °K	1761.21.2700	605,00	495,90
			1761.21.2700.D*	715,00	586,07
		3000 °K	1761.21.3000	605,00	495,90
			1761.21.3000.D*	715,00	586,07
	Copper Rame Kupfer Cobre Медь	2700 °K	1769.21.2700	605,00	495,90
			1769.21.2700.D*	715,00	586,07
		3000 °K	1769.21.3000	605,00	495,90
			1769.21.3000.D*	715,00	586,07
 <p>TESA Suspension</p>	Chrome Cromo Chrom Cromo Хром	2700 °K	1760.30.2700	825,00	676,23
			1760.30.2700.D*	935,00	766,39
		3000 °K	1760.30.3000	825,00	676,23
			1760.30.3000.D*	935,00	766,39
	Black Nero Schwarz Negro Чёрный цвет	2700 °K	1761.30.2700	825,00	676,23
			1761.30.2700.D*	935,00	766,39
		3000 °K	1761.30.3000	825,00	676,23
			1761.30.3000.D*	935,00	766,39
	Copper Rame Kupfer Cobre Медь	2700 °K	1769.30.2700	825,00	676,23
			1769.30.2700.D*	935,00	766,39
		3000 °K	1769.30.3000	825,00	676,23
			1769.30.3000.D*	935,00	766,39

* Dimmable with: Push 0-10V/1-10V/Dali/ normally open button
 Dimmerabile con: Push 0-10v / 1-10v/Dali / pulsante normalmente aperto
 Dimmbar über: Push 0-10V / 1-10V/Dali / Taste normalerweise offen
 Intensidad luminosa regulable con: Push 0-10v / 1-10v/Dali / botón normalmente abierto
 Диммируется с помощью Push 0-10v / 1-10v/Dali / с нормально разомкнутой кнопкой.

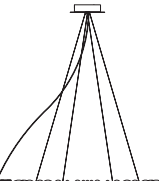
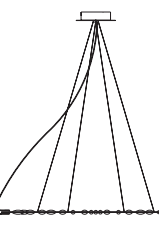
PRODUCT	FINISHES	°K	CODE	PRICE € incl VAT (22%)	PRICE € excl VAT	
 <p>LAFRA Horizontal Suspension Ø 45</p>	Chrome Cromo Chrom Cromo Хром	2700 °K	1748.34.2700	280,00	229,51	
			1748.34.2700.D*	361,00	295,90	
		3000 °K	1748.34.3000	280,00	229,51	
			1748.34.3000.D*	361,00	295,90	
	Plastic covers, Coperture plastica, Kunststoffabdeckungen, difusores en plástico, Пластиковые крышки			1748.34.Kit Cover	36,00	29,51
	Black Nero Schwarz Negro Чёрный цвет	2700 °K	1735.34.2700	280,00	229,51	
			1735.34.2700.D*	361,00	295,90	
		3000 °K	1735.34.3000	280,00	229,51	
			1735.34.3000.D*	361,00	295,90	
	Plastic covers, Coperture plastica, Kunststoffabdeckungen, difusores en plástico, Пластиковые крышки			1735.34.Kit Cover	36,00	29,51
	Copper Rame Kupfer Cobre Медь	2700 °K	1773.34.2700	280,00	229,51	
			1773.34.2700.D*	361,00	295,90	
3000 °K		1773.34.3000	280,00	229,51		
		1773.34.3000.D*	361,00	295,90		
Plastic covers, Coperture plastica, Kunststoffabdeckungen, difusores en plástico, Пластиковые крышки			1773.34.Kit Cover	36,00	29,51	
Gold Oro Gold Oro Золото	2700 °K	1739.34.2700	280,00	229,51		
		1739.34.2700.D*	361,00	295,90		
	3000 °K	1739.34.3000	280,00	229,51		
		1739.34.3000.D*	361,00	295,90		
Plastic covers, Coperture plastica, Kunststoffabdeckungen, difusores en plástico, Пластиковые крышки			1739.34.Kit Cover	36,00	29,51	
 <p>LAFRA Horizontal Suspension Ø 70</p>	Chrome Cromo Chrom Cromo Хром	2700 °K	1748.35.2700	648,00	531,15	
			1748.35.2700.D*	730,00	598,36	
		3000 °K	1748.35.3000	648,00	531,15	
			1748.35.3000.D*	730,00	598,36	
	Plastic covers, Coperture plastica, Kunststoffabdeckungen, difusores en plástico, Пластиковые крышки			1748.35.Kit Cover	105,00	86,07
	Black Nero Schwarz Negro Чёрный цвет	2700 °K	1735.35.2700	648,00	531,15	
			1735.35.2700.D*	730,00	598,36	
		3000 °K	1735.35.3000	648,00	531,15	
			1735.35.3000.D*	730,00	598,36	
	Plastic covers, Coperture plastica, Kunststoffabdeckungen, difusores en plástico, Пластиковые крышки			1735.35.Kit Cover	105,00	86,07
	Copper Rame Kupfer Cobre Медь	2700 °K	1773.35.2700	648,00	531,15	
			1773.35.2700.D*	730,00	598,36	
3000 °K		1773.35.3000	648,00	531,15		
		1773.35.3000.D*	730,00	598,36		
Plastic covers, Coperture plastica, Kunststoffabdeckungen, difusores en plástico, Пластиковые крышки			1773.35.Kit Cover	105,00	86,07	
Gold Oro Gold Oro Золото	2700 °K	1739.35.2700	648,00	531,15		
		1739.35.2700.D*	730,00	598,36		
	3000 °K	1739.35.3000	648,00	531,15		
		1739.35.3000.D*	730,00	598,36		
Plastic covers, Coperture plastica, Kunststoffabdeckungen, difusores en plástico, Пластиковые крышки			1739.35.Kit Cover	105,00	86,07	

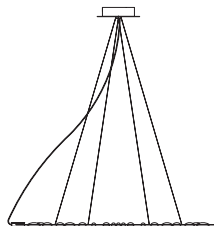
PRODUCT	FINISHES	°K	CODE	PRICE € incl VAT (22%)	PRICE € excl VAT	
 <p>LAFRA Horizontal Suspension Ø 95</p>	Chrome Cromo Chrom Cromo Хром	2700 °K	1748.36.2700	1.066,00	873,77	
			1748.36.2700.D*	1.148,00	940,98	
		3000 °K	1748.36.3000	1.066,00	873,77	
			1748.36.3000.D*	1.148,00	940,98	
	Plastic covers, Coperture plastica, Kunststoffabdeckungen, difusores en plástico, Пластиковые крышки			1748.36.Kit Cover	208,00	170,49
	Black Nero Schwarz Negro Чёрный цвет	2700 °K	1735.36.2700	1.066,00	873,77	
			1735.36.2700.D*	1.148,00	940,98	
		3000 °K	1735.36.3000	1.066,00	873,77	
			1735.36.3000.D*	1.148,00	940,98	
	Plastic covers, Coperture plastica, Kunststoffabdeckungen, difusores en plástico, Пластиковые крышки			1735.36.Kit Cover	208,00	170,49
	Copper Rame Kupfer Cobre Медь	2700 °K	1773.36.2700	1.066,00	873,77	
			1773.36.2700.D*	1.148,00	940,98	
3000 °K		1773.36.3000	1.066,00	873,77		
		1773.36.3000.D*	1.148,00	940,98		
Plastic covers, Coperture plastica, Kunststoffabdeckungen, difusores en plástico, Пластиковые крышки			1773.36.Kit Cover	208,00	170,49	
Gold Oro Gold Oro Золото	2700 °K	1739.36.2700	1.066,00	873,77		
		1739.36.2700.D*	1.148,00	940,98		
	3000 °K	1739.36.3000	1.066,00	873,77		
		1739.36.3000.D*	1.148,00	940,98		
Plastic covers, Coperture plastica, Kunststoffabdeckungen, difusores en plástico, Пластиковые крышки			1739.36.Kit Cover	208,00	170,49	

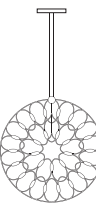
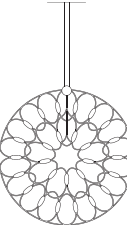
PRODUCT	FINISHES	°K	CODE	PRICE € incl VAT (22%)	PRICE € excl VAT		
 <p>LAFRA Vertical Suspension Ø 30</p>	Chrome Cromo Chrom Cromo Хром	2700 °K	1748.30.2700	200,00	163,93		
			3000 °K	1748.30.3000	200,00	163,93	
		Plastic covers, Coperture plastica, Kunststoffabdeckungen, difusores en plástico, Пластиковые крышки			1748.30.Kit Cover	28,00	22,95
		Black Nero Schwarz Negro Чёрный цвет	2700 °K	1735.30.2700	200,00	163,93	
	3000 °K			1735.30.3000	200,00	163,93	
			Plastic covers, Coperture plastica, Kunststoffabdeckungen, difusores en plástico, Пластиковые крышки			1735.30.Kit Cover	28,00
	Copper Rame Kupfer Cobre Медь		2700 °K	1773.30.2700	200,00	163,93	
		3000 °K		1773.30.3000	200,00	163,93	
			Plastic covers, Coperture plastica, Kunststoffabdeckungen, difusores en plástico, Пластиковые крышки			1773.30.Kit Cover	28,00
		Gold Oro Gold Oro Золото	2700 °K	1739.30.2700	28,00	22,95	
	3000 °K			1739.30.3000	251,00	205,74	
			Plastic covers, Coperture plastica, Kunststoffabdeckungen, difusores en plástico, Пластиковые крышки			1739.30.Kit Cover	333,00
 <p>LAFRA Vertical Suspension Ø 45</p>	Chrome Cromo Chrom Cromo Хром		2700 °K	1748.31.2700	251,00	205,74	
		1748.31.2700.D*		333,00	272,95		
		3000 °K	1748.31.3000	251,00	205,74		
			1748.31.3000.D*	333,00	272,95		
	Plastic covers, Coperture plastica, Kunststoffabdeckungen, difusores en plástico, Пластиковые крышки			1748.31.Kit Cover	36,00	29,51	
	Black Nero Schwarz Negro Чёрный цвет	2700 °K	1735.31.2700	251,00	205,74		
			1735.31.2700.D*	333,00	272,95		
		3000 °K	1735.31.3000	251,00	205,74		
			1735.31.3000.D*	333,00	272,95		
	Plastic covers, Coperture plastica, Kunststoffabdeckungen, difusores en plástico, Пластиковые крышки			1735.31.Kit Cover	36,00	29,51	
	Copper Rame Kupfer Cobre Медь	2700 °K	1773.31.2700	251,00	205,74		
			1773.31.2700.D*	333,00	272,95		
3000 °K		1773.31.3000	251,00	205,74			
		1773.31.3000.D*	333,00	272,95			
Plastic covers, Coperture plastica, Kunststoffabdeckungen, difusores en plástico, Пластиковые крышки			1773.31.Kit Cover	36,00	29,51		
Gold Oro Gold Oro Золото	2700 °K	1739.31.2700	251,00	205,74			
		1739.31.2700.D*	333,00	272,95			
	3000 °K	1739.31.3000	251,00	205,74			
		1739.31.3000.D*	333,00	272,95			
Plastic covers, Coperture plastica, Kunststoffabdeckungen, difusores en plástico, Пластиковые крышки			1739.31.Kit Cover	36,00	29,51		

* Dimmable with: Push 0-10V/1-10V/Dali/ normally open button
 Dimmerabile con: Push 0-10v / 1-10v/Dali / pulsante normalmente aperto
 Dimmbar über: Push 0-10V / 1-10V/Dali / Taste normalerweise offen
 Intensidad luminosa regulable con: Push 0-10v / 1-10v/Dali / botón normalmente abierto
 Диммируется с помощью Push 0-10в / 1-10в/Dali / с нормально разомкнутой кнопкой.

* Dimmable with normally open button / Dimmerabile con pulsante normalmente aperto / Dimmbar über taste normalerweise offen
 Intensidad luminosa regulable con botón normalmente abierto / Диммируется с помощью с нормально разомкнутой кнопкой.

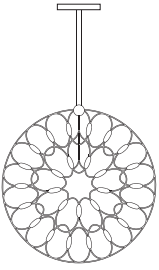
PRODUCT	FINISHES	°K	CODE	PRICE € incl VAT (22%)	PRICE € excl VAT	
 <p>LAFRA Vertical Suspension Ø 70</p>	Chrome Cromo Chrom Cromo Хром	2700 °K	1748.32.2700	580,00	475,41	
			1748.32.2700.D*	662,00	542,62	
		3000 °K	1748.32.3000	580,00	475,41	
			1748.32.3000.D*	662,00	542,62	
	Plastic covers, Coperture plastica, Kunststoffabdeckungen, difusores en plástico, Пластиковые крышки			1748.32.Kit Cover	105,00	86,07
	Black Nero Schwarz Negro Чёрный цвет	2700 °K	1735.32.2700	580,00	475,41	
			1735.32.2700.D*	662,00	542,62	
		3000 °K	1735.32.3000	580,00	475,41	
			1735.32.3000.D*	662,00	542,62	
	Plastic covers, Coperture plastica, Kunststoffabdeckungen, difusores en plástico, Пластиковые крышки			1735.32.Kit Cover	105,00	86,07
	Copper Rame Kupfer Cobre Медь	2700 °K	1773.32.2700	580,00	475,41	
			1773.32.2700.D*	662,00	542,62	
3000 °K		1773.32.3000	580,00	475,41		
		1773.32.3000.D*	662,00	542,62		
Plastic covers, Coperture plastica, Kunststoffabdeckungen, difusores en plástico, Пластиковые крышки			1773.32.Kit Cover	105,00	86,07	
Gold Oro Gold Oro Золото	2700 °K	1739.32.2700	580,00	475,41		
		1739.32.2700.D*	662,00	542,62		
	3000 °K	1739.32.3000	580,00	475,41		
		1739.32.3000.D*	662,00	542,62		
Plastic covers, Coperture plastica, Kunststoffabdeckungen, difusores en plástico, Пластиковые крышки			1739.32.Kit Cover	105,00	86,07	

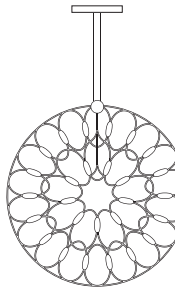
PRODUCT	FINISHES	°K	CODE	PRICE € incl VAT (22%)	PRICE € excl VAT	
 <p>LAFRA Vertical Suspension Ø 95</p>	Chrome Cromo Chrom Cromo Хром	2700 °K	1748.33.2700	950,00	778,69	
			1748.33.2700.D*	1.031,00	845,08	
		3000 °K	1748.33.3000	950,00	778,69	
			1748.33.3000.D*	1.031,00	845,08	
	Plastic covers, Coperture plastica, Kunststoffabdeckungen, difusores en plástico, Пластиковые крышки			1748.33.Kit Cover	208,00	170,49
	Black Nero Schwarz Negro Чёрный цвет	2700 °K	1735.33.2700	950,00	778,69	
			1735.33.2700.D*	1.031,00	845,08	
		3000 °K	1735.33.3000	950,00	778,69	
			1735.33.3000.D*	1.031,00	845,08	
	Plastic covers, Coperture plastica, Kunststoffabdeckungen, difusores en plástico, Пластиковые крышки			1735.33.Kit Cover	208,00	170,49
	Copper Rame Kupfer Cobre Медь	2700 °K	1773.33.2700	950,00	778,69	
			1773.33.2700.D*	1.031,00	845,08	
3000 °K		1773.33.3000	950,00	778,69		
		1773.33.3000.D*	1.031,00	845,08		
Plastic covers, Coperture plastica, Kunststoffabdeckungen, difusores en plástico, Пластиковые крышки			1773.33.Kit Cover	208,00	170,49	
Gold Oro Gold Oro Золото	2700 °K	1739.33.2700	950,00	778,69		
		1739.33.2700.D*	1.031,00	845,08		
	3000 °K	1739.33.3000	950,00	778,69		
		1739.33.3000.D*	1.031,00	845,08		
Plastic covers, Coperture plastica, Kunststoffabdeckungen, difusores en plástico, Пластиковые крышки			1739.33.Kit Cover	208,00	170,49	

* Dimmable with normally open button / Dimmerabile con pulsante normalmente aperto / Dimmbar über taste normalerweise offen / Intensidad luminosa regulable con botón normalmente abierto / Диммируется с помощью с нормально разомкнутой кнопкой.

* Dimmable with normally open button / Dimmerabile con pulsante normalmente aperto / Dimmbar über taste normalerweise offen / Intensidad luminosa regulable con botón normalmente abierto / Диммируется с помощью с нормально разомкнутой кнопкой.

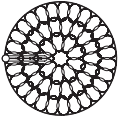
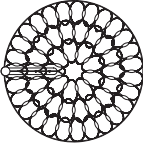
PRODUCT	FINISHES	°K	CODE	PRICE € incl VAT (22%)	PRICE € excl VAT	
 LAFRA Ceiling Ø 30	Chrome <i>Cromo</i> <i>Chrom</i> <i>Cromo</i> <i>Хром</i>	2700 °K	1748.20.2700	222,00	181,97	
		3000 °K	1748.20.3000	222,00	181,97	
	Plastic covers, <i>Coperture plastica, Kunststoffabdeckungen, difusores en plástico, Пластиковые крышки</i>			1748.20.Kit Cover	28,00	22,95
	Black <i>Nero</i> <i>Schwarz</i> <i>Negro</i> <i>Чёрный цвет</i>	2700 °K	1735.20.2700	222,00	181,97	
		3000 °K	1735.20.3000	222,00	181,97	
	Plastic covers, <i>Coperture plastica, Kunststoffabdeckungen, difusores en plástico, Пластиковые крышки</i>			1735.20.Kit Cover	28,00	22,95
	Copper <i>Rame</i> <i>Kupfer</i> <i>Cobre</i> <i>Медь</i>	2700 °K	1773.20.2700	222,00	181,97	
		3000 °K	1773.20.3000	222,00	181,97	
	Plastic covers, <i>Coperture plastica, Kunststoffabdeckungen, difusores en plástico, Пластиковые крышки</i>			1773.20.Kit Cover	28,00	22,95
	Gold <i>Oro</i> <i>Gold</i> <i>Oro</i> <i>Золото</i>	2700 °K	1739.20.2700	222,00	181,97	
3000 °K		1739.20.3000	222,00	181,97		
Plastic covers, <i>Coperture plastica, Kunststoffabdeckungen, difusores en plástico, Пластиковые крышки</i>			1739.20.Kit Cover	28,00	22,95	
 LAFRA Ceiling Ø 45	Chrome <i>Cromo</i> <i>Chrom</i> <i>Cromo</i> <i>Хром</i>	2700 °K	1748.21.2700	270,00	221,31	
			1748.21.2700.D*	351,00	287,70	
		3000 °K	1748.21.3000	270,00	221,31	
			1748.21.3000.D*	351,00	287,70	
	Plastic covers, <i>Coperture plastica, Kunststoffabdeckungen, difusores en plástico, Пластиковые крышки</i>			1748.21.Kit Cover	36,00	29,51
	Black <i>Nero</i> <i>Schwarz</i> <i>Negro</i> <i>Чёрный цвет</i>	2700 °K	1735.21.2700	270,00	221,31	
			1735.21.2700.D*	351,00	287,70	
		3000 °K	1735.21.3000	270,00	221,31	
			1735.21.3000.D*	351,00	287,70	
	Plastic covers, <i>Coperture plastica, Kunststoffabdeckungen, difusores en plástico, Пластиковые крышки</i>			1735.21.Kit Cover	36,00	29,51
Copper <i>Rame</i> <i>Kupfer</i> <i>Cobre</i> <i>Медь</i>	2700 °K	1773.21.2700	270,00	221,31		
		1773.21.2700.D*	351,00	287,70		
	3000 °K	1773.21.3000	270,00	221,31		
		1773.21.3000.D*	351,00	287,70		
Plastic covers, <i>Coperture plastica, Kunststoffabdeckungen, difusores en plástico, Пластиковые крышки</i>			1773.21.Kit Cover	36,00	29,51	
Gold <i>Oro</i> <i>Gold</i> <i>Oro</i> <i>Золото</i>	2700 °K	1739.21.2700	270,00	221,31		
		1739.21.2700.D*	351,00	287,70		
	3000 °K	1739.21.3000	270,00	221,31		
		1739.21.3000.D*	351,00	287,70		
Plastic covers, <i>Coperture plastica, Kunststoffabdeckungen, difusores en plástico, Пластиковые крышки</i>			1739.21.Kit Cover	36,00	29,51	

* Dimmable with normally open button / *Dimmerabile con pulsante normalmente aperto* / *Dimmbar über taste normalerweise offen* / *Intensidad luminosa regulable con botón normalmente abierto* / *Диммируется с помощью с нормально разомкнутой кнопкой.*

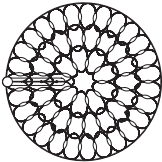
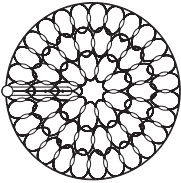
PRODUCT	FINISHES	°K	CODE	PRICE € incl VAT (22%)	PRICE € excl VAT	
 LAFRA Ceiling Ø 70	Chrome <i>Cromo</i> <i>Chrom</i> <i>Cromo</i> <i>Хром</i>	2700 °K	1748.22.2700	580,00	475,41	
			1748.22.2700.D*	580,00	475,41	
		3000 °K	1748.22.3000	662,00	542,62	
			1748.22.3000.D*	662,00	542,62	
	Plastic covers, <i>Coperture plastica, Kunststoffabdeckungen, difusores en plástico, Пластиковые крышки</i>			1748.22.Kit Cover	105,00	86,07
	Black <i>Nero</i> <i>Schwarz</i> <i>Negro</i> <i>Чёрный цвет</i>	2700 °K	1735.22.2700	580,00	475,41	
			1735.22.2700.D*	662,00	542,62	
		3000 °K	1735.22.3000	580,00	475,41	
			1735.22.3000.D*	662,00	542,62	
	Plastic covers, <i>Coperture plastica, Kunststoffabdeckungen, difusores en plástico, Пластиковые крышки</i>			1735.22.Kit Cover	105,00	86,07
Copper <i>Rame</i> <i>Kupfer</i> <i>Cobre</i> <i>Медь</i>	2700 °K	1773.22.2700	580,00	475,41		
		1773.22.2700.D*	662,00	542,62		
	3000 °K	1773.22.3000	580,00	475,41		
		1773.22.3000.D*	662,00	542,62		
Plastic covers, <i>Coperture plastica, Kunststoffabdeckungen, difusores en plástico, Пластиковые крышки</i>			1773.22.Kit Cover	105,00	86,07	
Gold <i>Oro</i> <i>Gold</i> <i>Oro</i> <i>Золото</i>	2700 °K	1739.22.2700	580,00	475,41		
		1739.22.2700.D*	662,00	542,62		
	3000 °K	1739.22.3000	580,00	475,41		
		1739.22.3000.D*	662,00	542,62		
Plastic covers, <i>Coperture plastica, Kunststoffabdeckungen, difusores en plástico, Пластиковые крышки</i>			1739.22.Kit Cover	105,00	86,07	
 LAFRA Ceiling Ø 95	Chrome <i>Cromo</i> <i>Chrom</i> <i>Cromo</i> <i>Хром</i>	2700 °K	1748.23.2700	931,00	763,11	
			1748.23.2700.D*	931,00	763,11	
		3000 °K	1748.23.3000	1.012,00	829,51	
			1748.23.3000.D*	1.012,00	829,51	
	Plastic covers, <i>Coperture plastica, Kunststoffabdeckungen, difusores en plástico, Пластиковые крышки</i>			1748.23.Kit Cover	208,00	170,49
	Black <i>Nero</i> <i>Schwarz</i> <i>Negro</i> <i>Чёрный цвет</i>	2700 °K	1735.23.2700	931,00	763,11	
			1735.23.2700.D*	1.012,00	829,51	
		3000 °K	1735.23.3000	931,00	763,11	
			1735.23.3000.D*	1.012,00	829,51	
	Plastic covers, <i>Coperture plastica, Kunststoffabdeckungen, difusores en plástico, Пластиковые крышки</i>			1735.23.Kit Cover	208,00	170,49
Copper <i>Rame</i> <i>Kupfer</i> <i>Cobre</i> <i>Медь</i>	2700 °K	1773.23.2700	931,00	763,11		
		1773.23.2700.D*	1.012,00	829,51		
	3000 °K	1773.23.3000	931,00	763,11		
		1773.23.3000.D*	1.012,00	829,51		
Plastic covers, <i>Coperture plastica, Kunststoffabdeckungen, difusores en plástico, Пластиковые крышки</i>			1773.23.Kit Cover	208,00	170,49	
Gold <i>Oro</i> <i>Gold</i> <i>Oro</i> <i>Золото</i>	2700 °K	1739.23.2700	931,00	763,11		
		1739.23.2700.D*	1.012,00	829,51		
	3000 °K	1739.23.3000	931,00	763,11		
		1739.23.3000.D*	1.012,00	829,51		
Plastic covers, <i>Coperture plastica, Kunststoffabdeckungen, difusores en plástico, Пластиковые крышки</i>			1739.23.Kit Cover	208,00	170,49	

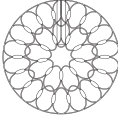
PRODUCT	FINISHES	°K	CODE	PRICE € incl VAT (22%)	PRICE € excl VAT	
 LAFRA Wall Ø 30	Chrome <i>Cromo</i> <i>Chrom</i> <i>Cromo</i> <i>Хром</i>	2700 °K	1748.10.2700	189,00	154,92	
		3000 °K	1748.10.3000	189,00	154,92	
	Plastic covers, <i>Coperture plastica, Kunststoffabdeckungen, difusores en plástico, Пластиковые крышки</i>			1748.10.Kit Cover	28,00	22,95
	Black <i>Nero</i> <i>Schwarz</i> <i>Negro</i> <i>Чёрный цвет</i>	2700 °K	1735.10.2700	189,00	154,92	
		3000 °K	1735.10.3000	189,00	154,92	
	Plastic covers, <i>Coperture plastica, Kunststoffabdeckungen, difusores en plástico, Пластиковые крышки</i>			1735.10.Kit Cover	28,00	22,95
	Copper <i>Rame</i> <i>Kupfer</i> <i>Cobre</i> <i>Медь</i>	2700 °K	1773.10.2700	189,00	154,92	
		3000 °K	1773.10.3000	189,00	154,92	
	Plastic covers, <i>Coperture plastica, Kunststoffabdeckungen, difusores en plástico, Пластиковые крышки</i>			1773.10.Kit Cover	28,00	22,95
	Gold <i>Oro</i> <i>Gold</i> <i>Oro</i> <i>Золото</i>	2700 °K	1739.10.2700	189,00	154,92	
3000 °K		1739.10.3000	189,00	154,92		
Plastic covers, <i>Coperture plastica, Kunststoffabdeckungen, difusores en plástico, Пластиковые крышки</i>			1739.10.Kit Cover	28,00	22,95	

 LAFRA Wall Ø 45	Chrome <i>Cromo</i> <i>Chrom</i> <i>Cromo</i> <i>Хром</i>	2700 °K	1748.11.2700	237,00	194,26	
			1748.11.2700.D*	318,00	260,66	
	3000 °K	1748.11.3000	237,00	194,26		
		1748.11.3000.D*	318,00	260,66		
	Plastic covers, <i>Coperture plastica, Kunststoffabdeckungen, difusores en plástico, Пластиковые крышки</i>			1748.11.Kit Cover	36,00	29,51
	Black <i>Nero</i> <i>Schwarz</i> <i>Negro</i> <i>Чёрный цвет</i>	2700 °K	1735.11.2700	237,00	194,26	
			1735.11.2700.D*	318,00	260,66	
	3000 °K	1735.11.3000	237,00	194,26		
		1735.11.3000.D*	318,00	260,66		
	Plastic covers, <i>Coperture plastica, Kunststoffabdeckungen, difusores en plástico, Пластиковые крышки</i>			1735.11.Kit Cover	36,00	29,51
Copper <i>Rame</i> <i>Kupfer</i> <i>Cobre</i> <i>Медь</i>	2700 °K	1773.11.2700	237,00	194,26		
		1773.11.2700.D*	318,00	260,66		
3000 °K	1773.11.3000	237,00	194,26			
	1773.11.3000.D*	318,00	260,66			
Plastic covers, <i>Coperture plastica, Kunststoffabdeckungen, difusores en plástico, Пластиковые крышки</i>			1773.11.Kit Cover	36,00	29,51	
Gold <i>Oro</i> <i>Gold</i> <i>Oro</i> <i>Золото</i>	2700 °K	1739.11.2700	237,00	194,26		
		1739.11.2700.D*	318,00	260,66		
3000 °K	1739.11.3000	237,00	194,26			
	1739.11.3000.D*	318,00	260,66			
Plastic covers, <i>Coperture plastica, Kunststoffabdeckungen, difusores en plástico, Пластиковые крышки</i>			1739.11.Kit Cover	36,00	29,51	

* Dimmable with normally open button / *Dimmerabile con pulsante normalmente aperto* / *Dimmbar über taste normalerweise offen* / *Intensidad luminosa regulable con botón normalmente abierto* / *Диммируется с помощью с нормально разомкнутой кнопкой.*

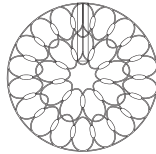

PRODUCT	FINISHES	°K	CODE	PRICE € incl VAT (22%)	PRICE € excl VAT	
 LAFRA Wall Ø 70	Chrome <i>Cromo</i> <i>Chrom</i> <i>Cromo</i> <i>Хром</i>	2700 °K	1748.12.2700	547,00	448,36	
			1748.12.2700.D*	629,00	515,57	
	3000 °K	1748.12.3000	547,00	448,36		
		1748.12.3000.D*	629,00	515,57		
	Plastic covers, <i>Coperture plastica, Kunststoffabdeckungen, difusores en plástico, Пластиковые крышки</i>			1748.12.Kit Cover	105,00	86,07
	Black <i>Nero</i> <i>Schwarz</i> <i>Negro</i> <i>Чёрный цвет</i>	2700 °K	1735.12.2700	547,00	448,36	
			1735.12.2700.D*	629,00	515,57	
	3000 °K	1735.12.3000	547,00	448,36		
		1735.12.3000.D*	629,00	515,57		
	Plastic covers, <i>Coperture plastica, Kunststoffabdeckungen, difusores en plástico, Пластиковые крышки</i>			1735.12.Kit Cover	105,00	86,07
Copper <i>Rame</i> <i>Kupfer</i> <i>Cobre</i> <i>Медь</i>	2700 °K	1773.12.2700	547,00	448,36		
		1773.12.2700.D*	629,00	515,57		
3000 °K	1773.12.3000	547,00	448,36			
	1773.12.3000.D*	629,00	515,57			
Plastic covers, <i>Coperture plastica, Kunststoffabdeckungen, difusores en plástico, Пластиковые крышки</i>			1773.12.Kit Cover	105,00	86,07	
Gold <i>Oro</i> <i>Gold</i> <i>Oro</i> <i>Золото</i>	2700 °K	1739.12.2700	547,00	448,36		
		1739.12.2700.D*	629,00	515,57		
3000 °K	1739.12.3000	547,00	448,36			
	1739.12.3000.D*	629,00	515,57			
Plastic covers, <i>Coperture plastica, Kunststoffabdeckungen, difusores en plástico, Пластиковые крышки</i>			1739.12.Kit Cover	105,00	86,07	

 LAFRA Wall Ø 95	Chrome <i>Cromo</i> <i>Chrom</i> <i>Cromo</i> <i>Хром</i>	2700 °K	1748.13.2700	895,00	733,61	
			1748.13.2700.D*	976,00	800,00	
	3000 °K	1748.13.3000	895,00	733,61		
		1748.13.3000.D*	976,00	800,00		
	Plastic covers, <i>Coperture plastica, Kunststoffabdeckungen, difusores en plástico, Пластиковые крышки</i>			1748.13.Kit Cover	208,00	170,49
	Black <i>Nero</i> <i>Schwarz</i> <i>Negro</i> <i>Чёрный цвет</i>	2700 °K	1735.13.2700	895,00	733,61	
			1735.13.2700.D*	976,00	800,00	
	3000 °K	1735.13.3000	895,00	733,61		
		1735.13.3000.D*	976,00	800,00		
	Plastic covers, <i>Coperture plastica, Kunststoffabdeckungen, difusores en plástico, Пластиковые крышки</i>			1735.13.Kit Cover	208,00	170,49
Copper <i>Rame</i> <i>Kupfer</i> <i>Cobre</i> <i>Медь</i>	2700 °K	1773.13.2700	895,00	733,61		
		1773.13.2700.D*	976,00	800,00		
3000 °K	1773.13.3000	895,00	733,61			
	1773.13.3000.D*	976,00	800,00			
Plastic covers, <i>Coperture plastica, Kunststoffabdeckungen, difusores en plástico, Пластиковые крышки</i>			1773.13.Kit Cover	208,00	170,49	
Gold <i>Oro</i> <i>Gold</i> <i>Oro</i> <i>Золото</i>	2700 °K	1739.13.2700	895,00	733,61		
		1739.13.2700.D*	976,00	800,00		
3000 °K	1739.13.3000	895,00	733,61			
	1739.13.3000.D*	976,00	800,00			
Plastic covers, <i>Coperture plastica, Kunststoffabdeckungen, difusores en plástico, Пластиковые крышки</i>			1739.13.Kit Cover	208,00	170,49	



PRICE LIST_CAOS CONTRACT

PRODUCT	FINISHES	CODE	PRICE incl VAT (22%)	PRICE excl VAT
 <p>CAOS CONTRACT Suspension</p>	Black Nero Schwarz Negro Чёрный цвет	1819.33	293,00	240,16
	Brushed gold Oro spazzolato Gold gebürstet Oro cepillado Брашированное золото	1818.33	293,00	240,16
 <p>CAOS CONTRACT Suspension</p>	Black Nero Schwarz Negro Чёрный цвет	1819.34	321,00	263,11
	Brushed gold Oro spazzolato Gold gebürstet Oro cepillado Брашированное золото	1818.34	321,00	263,11
 <p>CAOS CONTRACT Suspension</p>	Black Nero Schwarz Negro Чёрный цвет	1819.35	357,00	292,62
	Brushed gold Oro spazzolato Gold gebürstet Oro cepillado Брашированное золото	1818.35	357,00	292,62

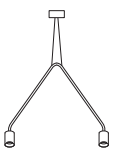
PRICE LIST_CAOS

PRODUCT	FINISHES	CODE	PRICE incl VAT (22%)	PRICE excl VAT
 <p>CAOS Suspension</p>	Black Nero Schwarz Negro Чёрный цвет	1819.30	195,00	159,84
	Brushed gold Oro spazzolato Gold gebürstet Oro cepillado Брашированное золото	1818.30	195,00	159,84
 <p>CAOS Suspension</p>	Black Nero Schwarz Negro Чёрный цвет	1819.31	261,00	213,93
	Brushed gold Oro spazzolato Gold gebürstet Oro cepillado Брашированное золото	1818.31	261,00	213,93
 <p>CAOS Suspension</p>	Black Nero Schwarz Negro Чёрный цвет	1819.32	360,00	295,08
	Brushed gold Oro spazzolato Gold gebürstet Oro cepillado Брашированное золото	1818.32	360,00	295,08

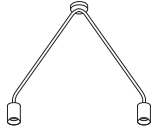

PRICE LIST_CAOS

PRODUCT	FINISHES	CODE	PRICE incl VAT (22%)	PRICE excl VAT
 CAOS Ceiling	Black Nero Schwarz Negro Чёрный цвет	1819.20	156,00	127,87
	Brushed gold Oro spazzolato Gold gebürstet Oro cepillado Брашированное золото	1818.20	156,00	127,87
 CAOS Ceiling	Black Nero Schwarz Negro Чёрный цвет	1819.21	214,00	175,41
	Brushed gold Oro spazzolato Gold gebürstet Oro cepillado Брашированное золото	1818.21	214,00	175,41
 CAOS Ceiling	Black Nero Schwarz Negro Чёрный цвет	1819.22	289,00	236,89
	Brushed gold Oro spazzolato Gold gebürstet Oro cepillado Брашированное золото	1818.22	289,00	236,89

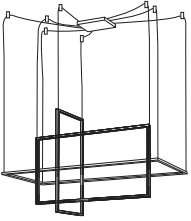
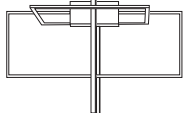
PRICE LIST_AREA

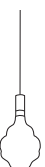

PRODUCT	FINISHES	°K	CODE	PRICE incl VAT (22%)	PRICE excl VAT
 AREA Suspension	Aluminium Alluminio Aluminium Aluminio Алюминий	3000 °K	1737.36.ALL	1.060,00	868,85
	Black Nero Schwarz Negro Чёрный цвет	3000 °K	1737.36.N	1.170,00	959,02
 AREA Ceiling	Aluminium Alluminio Aluminium Aluminio Алюминий	3000 °K	1737.20.ALL	755,00	618,85
	Black Nero Schwarz Negro Чёрный цвет	3000 °K	1737.20.N	865,00	709,02

PRICE LIST_HONEY BLACK

PRODUCT	GLASS FINISHES	°K	CODE	PRICE incl VAT (22%)	PRICE excl VAT
 <p>HONEY BLACK Suspension</p>	Trasparent Trasparente Transparent Transparente Прозрачный	3000 °K	1719.V.30	59,00	48,36
 <p>HONEY BLACK Suspension</p>	Trasparent Trasparente Transparent Transparente Прозрачный	3000 °K	1719.V.31	59,00	48,36
 <p>HONEY BLACK Suspension</p>	Trasparent Trasparente Transparent Transparente Прозрачный	3000 °K	1719.V.32	59,00	48,36

PRICE LIST_HONEY BLACK

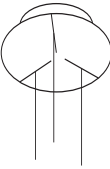
PRODUCT	FINISHES	CODE	PRICE incl VAT (22%)	PRICE excl VAT
 <p>HONEY BLACK Suspension</p>	One-light canopy with cable and LED module <i>Montatura 1 luce completa di cavo e modulo LED</i> <i>Gestell 1 Licht inklusive Kabel und LED-Modul</i> <i>Florón 1 luz con cable y módulo LED</i> <i>Рамка с 1 светоэлементом в комплекте с кабелем и светодиодным модулем</i>	1802.M.30	182,00	149,18
 <p>HONEY BLACK Suspension</p>	Three-lights round canopy with cable and LED module <i>Montatura tonda 3 luci completa di cavo e modulo LED</i> <i>Rundes Gestell 3 Lichter inklusive Kabel und LED-Modul</i> <i>Florón redondo 3 luces con cable y módulo LED</i> <i>Круглая рамка с 3 светоэлементами в комплекте с кабелем и светодиодным модулем</i>	1802.M.31	605,00	495,90
 <p>HONEY BLACK Suspension</p>	Five-lights round canopy with cable and LED module <i>Montatura tonda 5 luci completa di cavo e modulo LED</i> <i>Rundes Gestell 5 Lichter inklusive Kabel und LED-Modul</i> <i>Florón redondo 5 luces con cable y módulo LED</i> <i>Круглая рамка с 5 светоэлементами в комплекте с кабелем и светодиодным модулем</i>	1802.M.32	908,00	744,26
 <p>HONEY BLACK Suspension</p>	Ten-lights round canopy with cable and LED module <i>Montatura tonda 10 luci Kit completa di cavo e modulo LED</i> <i>Rundes Gestell 10 Lichter Set inklusive Kabel und LED-Modul</i> <i>Florón redondo 10 luces con cable y módulo LED</i> <i>Круглая рамка с 10 светоэлементами в комплекте с кабелем и светодиодным модулем</i>	1802.M.33	1.513,00	1.240,16

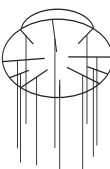
PRODUCT	FINISHES	CODE	PRICE incl VAT (22%)	PRICE excl VAT
 <p>BEBA Suspension</p>	<p>One-light canopy Montatura 1 luce Gestell 1 Licht Florón 1 luz Рамка с 1 светозаэлементом</p>	1730.M.30	65,00	53,28
 <p>BEBA Suspension</p>	<p>Three-lights round canopy Montatura tonda 3 luci Kit Rundes Gestell 3 Lichter Set Florón redondo 3 luces Круглая рамка с 3 светозаэлементами Комплект</p>	1730.M.34	270,00	221,31
 <p>BEBA Suspension</p>	<p>Five-lights round canopy Montatura tonda 5 luci Kit Rundes Gestell 5 Lichter Set Florón redondo 5 luces Круглая рамка с 5 светозаэлементами Комплект</p>	1730.M.35	420,00	344,26
 <p>BEBA Suspension</p>	<p>Ten-lights round canopy Montatura tonda 10 luci Kit Rundes Gestell 10 Lichter Set Florón redondo 10 luces Круглая рамка с 10 светозаэлементами Комплект</p>	1730.M.36	894,00	732,79

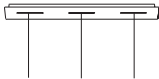
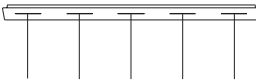
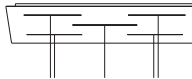
PRODUCT	GLASS FINISHES	CODE	PRICE € incl VAT (22%)	PRICE € excl VAT
	<p>Three-lights linear canopy with cables and lamp holder Montatura lineare 3 luci con cavi e portalampada Lineares Gestell 3 Lichter mit Kabeln und Fassung Montaje lineal 3 luces con cables y portalámparas Линейная рамка с 3 светозаэлементами с кабелями и держателем лампы Комплект</p>	1730.M.40	210,00	172,13
	<p>Five-lights linear canopy with cables and lamp holder Montatura lineare 5 luci con cavi e portalampada Lineares Gestell 5 Lichter mit Kabeln und Fassung Montaje lineal 5 luces con cables y portalámparas Линейная рамка с 5 светозаэлементами с кабелями и держателем лампы Комплект</p>	1730.M.41	327,00	268,03
	<p>Five-lights rectangular canopy with cables and lamp holder Montatura rettangolare 5 luci con cavi e portalampada Rechteckiges Gestell 5 Lichter mit Kabeln und Fassung Montaje rectangular 5 luces con cables y portalámparas Прямоугольная рамка с 5 светозаэлементами с кабелями и держателем лампы Комплект</p>	1730.M.42	423,00	346,72

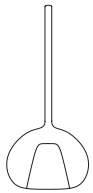
PRODUCT	GLASS FINISHES	CODE	PRICE incl VAT (22%)	PRICE excl VAT
 <p>BEBA Glass 15 x 35</p>	TrSPARENT TrSPARENTe TrSPARENT TrSPARENTe Прозрачный	1730.V.TR	53,70	44,02
	Chrome Cromo Chrom Cromo Хром	1730.V.CR	87,00	71,31
	Bronze Bronzo Bronze Bronze бронза	1730.V.BZ	87,00	71,31
	Gold Oro Gold Oro Золото	1730.V.GOLD	87,00	71,31
 <p>BEBA Glass 20 x 45</p>	TrSPARENT TrSPARENTe TrSPARENT TrSPARENTe Прозрачный	1730.V.BIG.TR	105,00	86,07
	Chrome Cromo Chrom Cromo Хром	1730.V.BIG.CR	126,00	103,28
	Bronze Bronzo Bronze Bronze бронза	1730.V.BIG.BZ	126,00	103,28
	Gold Oro Gold Oro Золото	1730.V.BIG.GOLD	126,00	103,28

JANUARY 2023

THANKS TO:

CONCEPT & DEVELOPMENT: Red Apple International
AD: Marco Spatti
PHOTO: Paolo Volontè
FURNITURE: Bross Italia, Living Divani, Desalto, Moroso
CERAMICS: Paola Paronetto
RENDERING: Widestudio

Viale dell'Industria, 21
20037 Paderno Dugnano (MI) - Italy
Tel. +39 02 9104958 r.a. - +39 02 9105178
Fax +39 02 9185542
info@sforzinilluminazione.com
www.sforzinilluminazione.com

URBAN
L I G H T I N G